

Ther-mix



Instructions for Use



 This Manual Copyright © 2016 ITL 

All rights reserved. No part of this manual may be reproduced, stored in a retrieval system, or transmitted, by any means or in any form, without the prior permission of Integrated Technologies Limited (ITL).

The information contained in this manual is subject to change without notice. ITL assumes no responsibility for any errors that may appear in this or related documentation.

Document: V501002
Revision: 1-1604

Vitl is the brand name for Integrated Technologies' own range of laboratory products. For further information please visit the Vitl web site:

www.vitlproducts.com

All sales and technical enquiries should be addressed to:

UK Vitl Customer Services
Integrated Technologies Limited
Viking House, Ellingham Way, Ashford, Kent, TN23 6NF
United Kingdom
+44 (0)1233 638383
sales@vitlproducts.com

USA ITL Virginia Inc
305 Ashcake Road, Suite L, Ashland, Virginia 23005
USA
+1 804-381-0905
sales@vitlproducts.com

CHINA Integrated Electronic Systems (Shanghai) Co Ltd
T3-11 Unit 201, No. 5001 Hua Dong Road, Pudong,
Shanghai 201201, China
+86 (0)21 585 854 63
sales@vitlproducts.com

Contents

1	☉ Symbols Used in this Instruction Manual.....	5
2	☉ Safety Precautions and Limitations of Use	6
3	☉ Regulatory Limitations of Use	10
4	☉ Unit Description.....	11
5	☉ Unit Installation.....	13
6	☉ Basic Unit Operation	14
6.1	☉ User Display and Controls	14
6.2	☉ Attaching a Heated Module.....	18
6.3	☉ Unit Shutdown Procedure	19
6.4	☉ Mixing with Flexible User Parameters.....	19
6.5	☉ Pre-defined Mixing Programs.....	24
6.6	☉ User-defined Mixing Programs.....	25
7	☉ Advanced Program and Set-up Features.....	26
7.1	☉ Program Tools.....	26
7.1.1	☉ Favourite Programs List	27
7.1.2	☉ Creating a New User-defined Program	28
7.1.3	☉ Changing the Program ID, Info and Parameters.....	29
7.1.4	☉ Deleting a User-defined Program.....	30
7.2	☉ Profiled Mixing Programs	31
7.3	☉ User Preferences and Options.....	36
7.3.1	☉ Beeper and Button Click Volume	37
7.3.2	☉ LCD Backlight Brightness Level.....	37
7.3.3	☉ Cooling Fan Operating Mode	37
7.3.4	☉ Program Set-up Protection Mode.....	37
7.3.5	☉ Standby Mode	38
8	☉ Troubleshooting.....	39
9	☉ Maintenance and Servicing.....	41
9.1	☉ Replacing the Unit Fuse.....	41
9.2	☉ Routine Cleaning and Inspection	42
9.3	☉ Decontamination Procedure.....	44
9.4	☉ Transportation and Storage	45
9.5	☉ Product Disposal	45
10	☉ Warranty and Returns	46
11	☉ Technical Specification	47
12	☉ Glossary of Terms and Abbreviations	48



WARNING

Please ensure that you have read and fully understood the **Safety Precautions and Limitations of Use** in section 2 of this manual, and the associated **Heated Module Instructions for Use**, before attempting to install or operate this product.

Failure to do so could result in serious injury or death, or may damage the unit and invalidate the product warranty.

 **Tables** 

Table 1: Advisory Symbol Meanings 5

Table 2: Unit Features 11

Table 3: Unit Accessories 12

Table 4: Page Selection Tabs 14

Table 5: Button Quick Reference 17

Table 6: Common Action Button Presses 18

Table 7: Temperature Set-point and Readout 22

Table 8: Program Tools Options 27

Table 9: Program Editing Functions 29

Table 10: Program Profiling Function Buttons 33

Table 11: Program Profile Step Parameters 34

Table 12: Profile Editing Functions 35

Table 13: User Preferences and Options 36









Table 14: Protected Function Buttons 38

Table 15: Troubleshooting Suggestions 39

Table 16: Unit Error Codes 40

1 Symbols Used in this Instruction Manual



The following advisory symbols are used in this manual.

Table 1: Advisory Symbol Meanings	
 DANGER	Indicates a Risk of Electric Shock which could, if not avoided, result in severe injury or death.
 DANGER	Indicates a Burn Hazard which could, if not avoided, result in severe injury or death.
 DANGER	Indicates a Risk of Explosion which could, if not avoided, result in severe injury or death.
 WARNING	Indicates a hazardous situation which could, if not avoided, result in severe injury or death; or severely damage the unit.
 CAUTION	Indicates a hazardous situation which could, if not avoided, result in minor or moderate injury; or degrade or impair the functionality of the unit.
 CAUTION	Indicates an Electrostatic-Sensitive Device for which care should be taken not to touch the exposed electrical contacts as this could degrade or impair the functionality of the unit.
 CAUTION	Indicates a possible crush hazard due to moving parts which could, if not avoided, result in minor or moderate injury.
	Advisory or other useful information.
	Refer to “section NN” for more details.



2 Safety Precautions and Limitations of Use

It is essential that all users of this equipment have fully read and understood the following safety precautions and limitations of use before installing or operating the Ther-mix unit.

IMPORTANT

 WARNING	<p>The protection provided by this equipment may be impaired if it is not used in a manner described in this manual.</p>
 WARNING	<p>It is essential that the user of this equipment is aware of the potential hazards associated with the unit and its accessories. All operators should be familiar with the safety precautions and warnings given in these instructions before attempting to operate the unit.</p> <p>Improper use of this unit or its accessories may impair their functionality and invalidate the manufacturer’s warranty.</p>

Unit Handling Precautions

 CAUTION	<p>Care should be taken not to drop the unit or subject it to rough physical handling, both during normal use and during installation, transportation and storage.</p> <p>Do not use the unit if it shows any signs of damage or wear.</p>
 WARNING	<p>The unit should be held and supported in both hands when lifting or moving. Do not lift the unit by the mixer platform or Heated Module.</p> <p>The base of the unit is cast from solid metal and is designed to be heavy. Care should be taken to avoid trapping fingers under the unit when placing it down on a solid surface.</p>
 CAUTION	<p>Care should be taken not to knock the LCD display.</p> <p>Do not use excessive force when pressing the touchscreen buttons or when cleaning it.</p>

Unit Installation and Operating Environment



DANGER

The Ther-mix unit is designed for indoor laboratory use only. The acceptable operating temperature range is 18°C to 38°C, with a relative humidity of 20% to 85% non-condensing, at a maximum altitude of 2000m above sea level.



WARNING

If the unit is stored in conditions outside of these ranges, it must be left to stand unpowered until it has acclimatised to within these environmental limits before being powered.

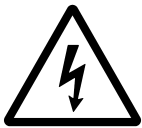

DANGER

Use only the AC mains power cord provided with the unit or as specified in section 11 of this manual.

The unit must be connected to a suitably earthed mains supply, with appropriate earth-leakage and over-current protection.



WARNING

Always ensure that the mains power connector is securely inserted into the rear of the unit, and any excess power cord does not pose a potential trip or pull hazard.



DANGER

Do not operate the unit in any area which is, or has been, or is thought to have been exposed to explosive or flammable gases, vapours or liquids.



WARNING

The unit must be installed and operated on a solid, stable, vibration-free and level working surface; ensuring that the ventilation slots on the underside of the unit are not blocked.



CAUTION

The unit can create strong vibrations at high speeds which may cause objects positioned in close proximity to the unit to also vibrate and move.

Do not place easily movable objects near the unit; or ensure such objects are appropriately secured.

General Operating Precautions



DANGER

Ensure that the power is switched off at both the AC mains supply outlet and at the back of the unit before inserting or removing the mains power cord.

However, if a spillage occurs in or over the unit, always switch the power off and unplug the power cord at the mains supply outlet first, before attempting to deal with the spill.



DANGER

The heaters can reach temperatures of 105°C and will remain hot for a considerable time after being turned off.

Extreme care must be taken not to touch the heated surfaces as they may cause a severe burn injury.



DANGER

The unit is intended for use with aqueous solutions and suspensions only.

Never use the unit to mix any explosive, volatile or highly reactive substances or chemicals.



WARNING

To avoid liquid spills and possible cross-contamination of samples, only use sealed plates and closed tubes.

Always follow prescribed laboratory procedures and use appropriate personal protective equipment (PPE - such as gloves, clothing, goggles, etc) when handling samples.



WARNING

Injury can occur from flying plates and tubes if they are not correctly inserted and secured, or if the maximum recommended mixing speed is exceeded.

Always ensure that plates and tubes are correctly inserted and secured by the module lid. Also ensure that plate dimensions comply with the ANSI/SBS Standards for Microplates.



CAUTION

There is a possible finger crush hazard due to moving parts.

Do not open the Heated Module lid or attempt to remove or replace any sample plates or tubes whilst the mixer is running or still moving.



CAUTION

Do not touch the exposed electrical contacts of the unit or associated Heated Modules as an Electrostatic Discharge (ESD) could degrade or impair the functionality of the unit.

**CAUTION**

For optimum thermal performance and to prevent dirt build-up or ingress, always keep the Heated Module lid closed when not accessing the sample plates or tubes.

Unit Maintenance and Serviceability

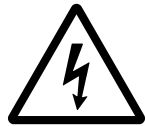
**DANGER**

There are no user or operator serviceable parts inside the unit. Do not remove the unit casework.

**WARNING**

Removal of the unit's casework will void the manufacturer's warranty and may expose the user to a Risk of Electric Shock resulting in serious injury or death.

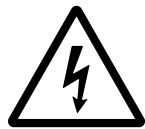
**DANGER**

The externally accessible unit fuse will only blow under an extreme internal fault condition. This fuse should only be changed after the unit has been thoroughly inspected by a qualified engineer. See section 9.1 for details.

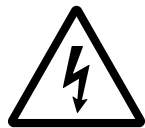
**DANGER**

Always switch off the unit and disconnect the power cord before performing any cleaning or decontamination procedure. If liquid is spilt into or over the unit, switch off and disconnect the power from the AC mains outlet before attempting to deal with the spillage.

**CAUTION**

Ensure that the heated surfaces have cooled down to room temperature before performing any cleaning operation and before moving or storing the unit.

**CAUTION**

The use of harsh chemicals and cleaning agents may damage the unit and degrade its performance.

Always follow the cleaning and decontamination procedures specified in sections 9.2 and 9.3 of this instruction manual.

3 Regulatory Limitations of Use

Declaration of Conformity



ELECTRICAL SAFETY
E113628

Integrated Technologies Limited (ITL) affirm that this product fulfils the essential requirements of the Low Voltage Directive (LVD) 2006/95/EC and the EMC Directive 2004/108/EC, when installed and operated in accordance with the instructions in this manual.

The Ther-mix unit has been type tested by Element Materials Technology (UKAS accredited Testing Laboratory No 0026) against the Safety and EMC Requirements listed below, and issued Certificate Nos GB-EMT 0754 and TRA-029311-38.

Safety and EMC Requirements

SAFETY

- EN 61010-1:2010, 61010-2-010:2003, 61010-2-051:2003
- UL 61010-1:2001 3rd Edition (CAN C22.2 CSA 61010-1)

EMC

- EN 61326:2006, Class B
- FCC CFR 47 Parts 15.107 and 15.109, Class A

RoHS and WEEE Directive Compliance



This product complies with the requirements of the RoHS2 Directive 2011/65/EU for Electrical and Electronic Equipment.

Where applicable, the Ther-mix unit should be disposed of in accordance with the European Union WEEE Directive 2002/96/EC on Waste Electrical and Electronic Equipment.

Do not dispose of this product into unsorted municipal waste or public landfill. Please refer to section 9.5 for details of how to correctly dispose of this product.

The Ther-mix unit is designed and manufactured under ISO 9001 by:

Integrated Technologies Limited

Viking House, Ellingham Way, Ashford, Kent, TN23 6NF
United Kingdom

4 Unit Description

The Ther-mix unit is a versatile heated sample mixer and has the following external features:

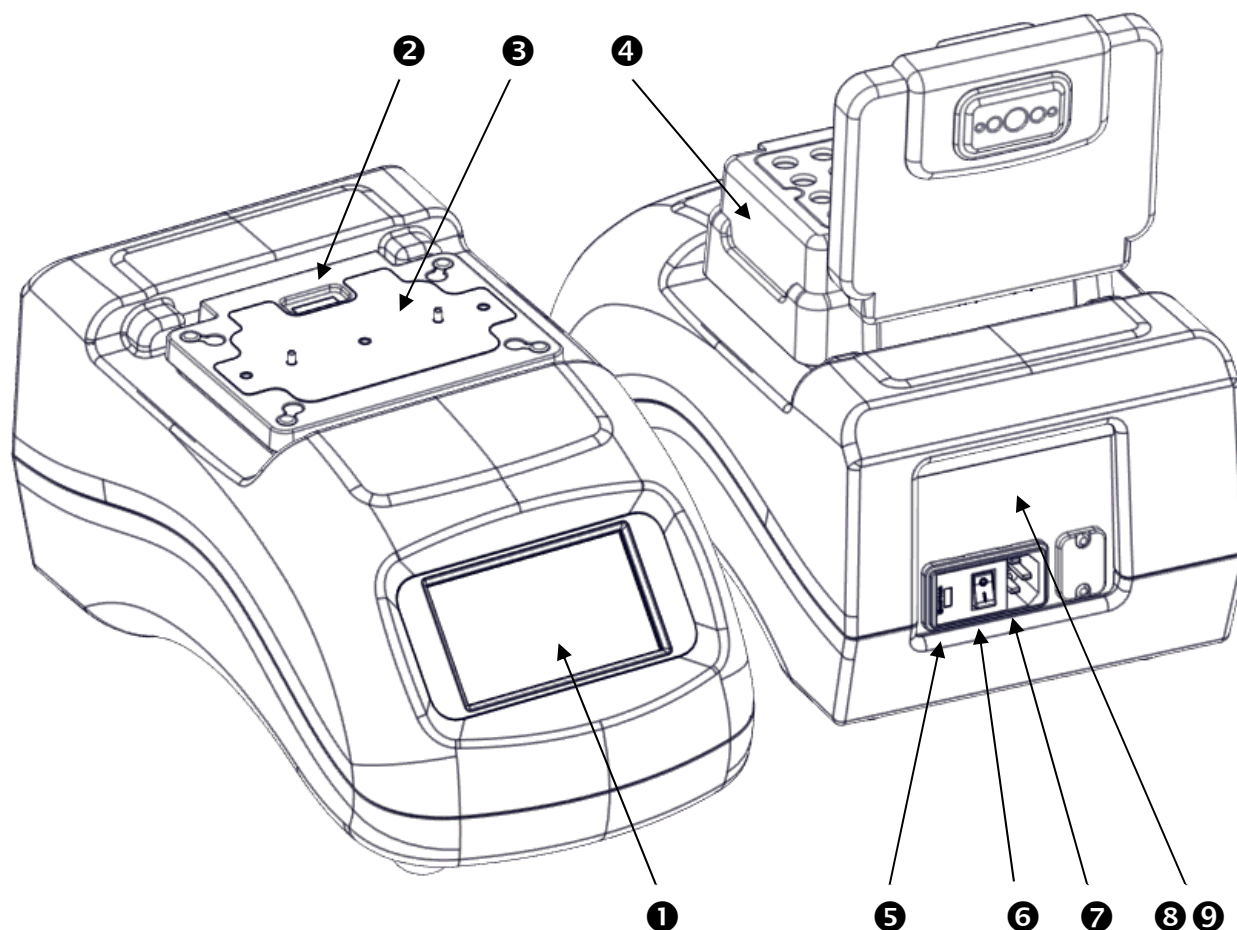
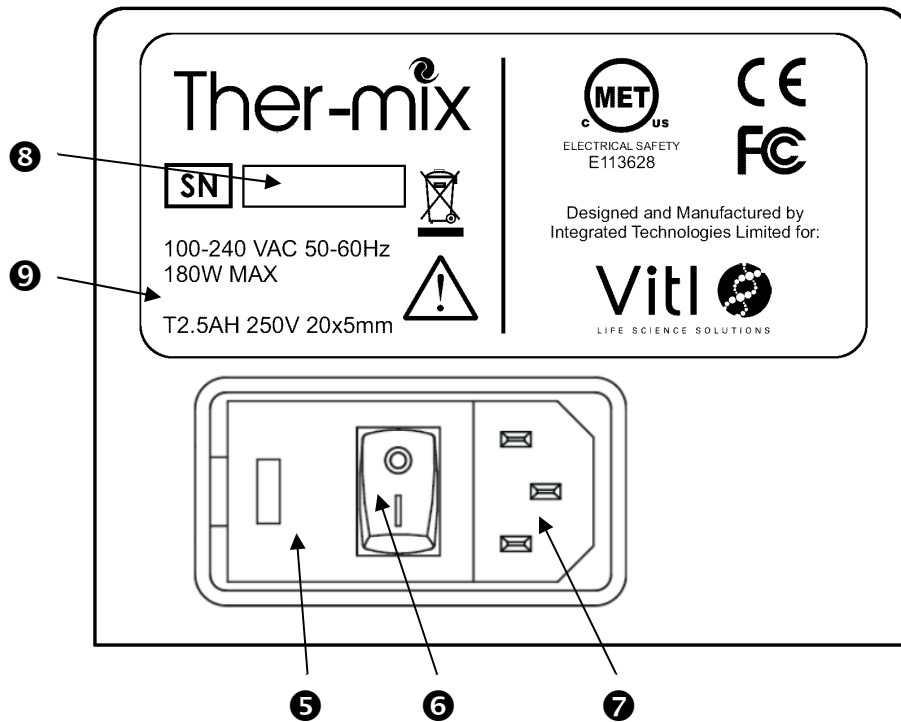

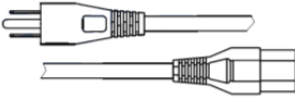

Table 2: Unit Features

1	LCD Touchscreen User Interface	⇒ 6.1
2	Heated Module Interface Port	⇒ 6.2
3	Heated Module Docking Platform	⇒ 6.2
4	Heated Module (sold separately)	⇒ 6.2
5	External Fuse Access Cover	⇒ 9.1
6	Mains Power On/Off Switch	⇒ 5
7	Mains Power Inlet	⇒ 5
8	Unit Label and Serial Number	⇒ 4
9	Mains Power and Fuse Ratings	⇒ 11

The unit label is located at the rear and provides general ratings information:



The unit is also supplied with the following accessories:

Table 3: Unit Accessories		
	Mains power cord (varies according to country of use)	⇒ 5
		⇒ 11
	3mm hex-driver Module Securing Tool	⇒ 6.2

The Ther-mix base-unit uses the Vitl range of Heated Modules, which are interchangeable sample block heaters specifically designed for particular sample plate and tube types. Please contact your distributor to ensure you have the most appropriate module for your application.

Other optional accessories and specialist Heated Modules may be available on request. Please contact your distributor for details.

5 Unit Installation

Before installing the Ther-mix unit, please check that the delivery is complete (see Table 3) and that the unit and all accessory parts are intact and free from any signs of transportation damage. Also ensure that all external and internal packaging has been removed from the unit before installation.



Please retain all packaging for future transportation and storage of the unit and its accessories.

The Ther-mix unit should be installed in a location which meets the following requirements:

- Safe and suitable operating environment (see section 2)
- Solid, stable, vibration-free and level working surface
- At least 10cm clearance around the unit to adjacent objects and walls
- Earthed AC mains power connection (see section 11)



WARNING

Please also observe and abide by the **Unit Installation and Operating Environment** safety precautions and preconditions listed in section 2 of this manual and the associated **Heated Module Instructions for Use**.

Install and test the Ther-mix unit using the following procedure:

1. Place the Ther-mix unit on the suitably selected working surface (as specified above), ensuring that the ventilation slots on the underside of the unit are not covered or blocked.
2. Connect the unit to the AC mains power outlet using the mains power cord supplied (see section 4).
3. Switch the mains power on at supply outlet first, and then switch the unit on using the power switch located at the rear of the unit.
4. Carry out a mixing test with the required Heated Module and at the maximum required speed (using the flexible THERMIX program described in section 6.4) to determine if the grip between the unit and the working surface is sufficient to prevent the unit from moving.
5. If the level of grip is sufficient, then the Ther-mix unit should not be moved from this installed position.

If the unit needs to be repositioned in the future, then the above installation procedure should be repeated at the new location.

6 Basic Unit Operation



WARNING



Please ensure that you have read and fully understood all of the **Safety Precautions and Limitations of Use** listed in section 2 before attempting to operate the Ther-mix unit.

6.1 User Display and Controls

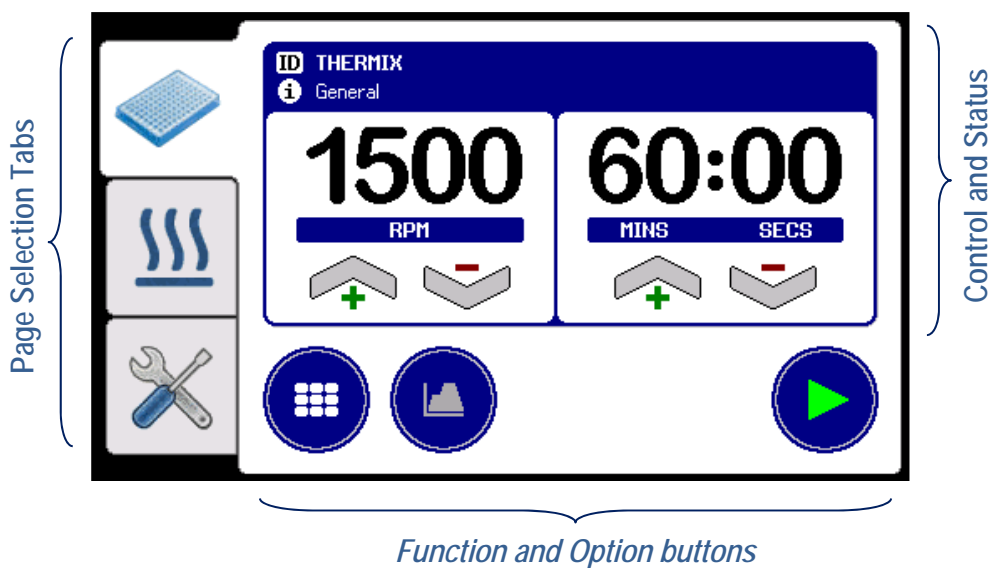
The unit’s user interface consists of a colour LCD touchscreen, with page selection tabs located down the left-hand side of the display, and function buttons along the bottom.

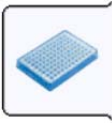

The Ther-mix is designed to allow simultaneous mixing and heating of sample plates and tubes, by providing easy display mode switching using the three page selection tabs shown in Table 4.

Table 4: Page Selection Tabs		
	Plate and tube Mixer control and status	⇒ 6.4
	Block and Lid Heater control and status	⇒ 6.4
	User Preferences and options	⇒ 7.3

The unit can store up to 100 mixing and heating programs (each with different speed, time and temperature settings) and is preloaded with up to eight commonly used programs.

The program selection grid on the **Mixer** tab shows the available programs, arranged as a 3x3 scrolling grid list.

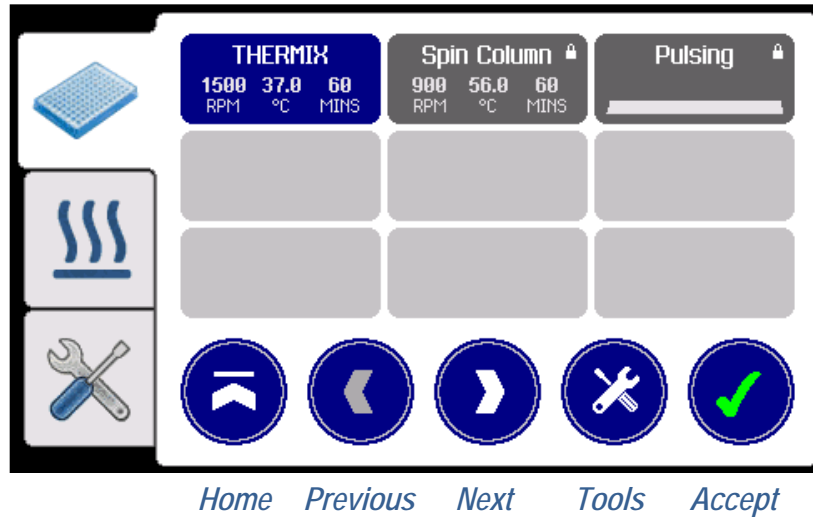

i If a Heated Module is attached, it will automatically select the program that it most recently ran. Hence, when swapping between modules, each module remembers the last program it used.

Each program selection button shows the program’s ID and the assigned speed, block temperature and time parameters.

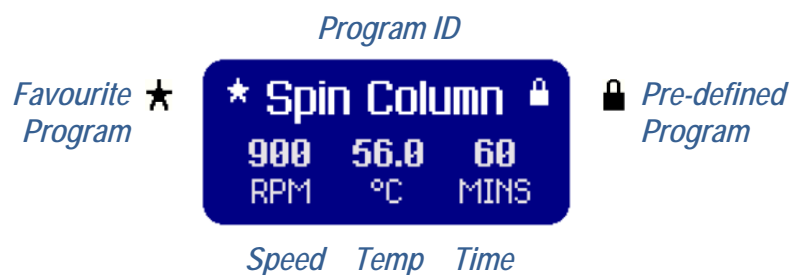

Before a program can be loaded and run, a suitable Heated Module must first be attached to the mixer docking platform. Refer to section 6.2 for details.

Use the **Home** button to jump to the top of the program grid list or the **Next** and **Previous** buttons to scroll through the list to highlight the desired program. Then press the **Accept** button to load the program.



Please note that the mixer will not operate until a Heated Module has been attached (see section 6.2 below).





















NOTE

The **Tools** button allows access to advanced program set-up functions, including user-defined programs and profiled mixing programs.





















































Once the unit has been fully set-up, the program set-up functions can be disabled to prevent accidental modifications. Refer to section 7.3 for details.

The user interface and controls are described in detail in sections 6.4 and 7. Below is a quick reference guide to the main button functions.

Table 5: Button Quick Reference	
 	Accept or Cancel option
  	Home , Previous or Next program ⇒ 6.4
	Program Tools menu ⇒ 7.1
	Exit to previous menu
	Add/remove Favourite program ⇒ 7.1.1
  	New , Edit or Delete program ⇒ 7.1
 	Change program ID or Info ⇒ 7.1.3
	Unlock program parameters ⇒ 7.1.3
 	Increase or Decrease setting ⇒ 6.4
	Show Program selection grid list ⇒ 6.4
	Mixer program Profile edit ⇒ 7.2
 	Start and Stop mixing ⇒ 6.4

The user preferences and set-up option buttons are detailed in section 7.3.

Table 6 provides an overview of the button presses required to perform certain common actions.

Table 6: Common Action Button Presses		
Action	Button Sequence	
Load a program	 →  →  →  → 	⇒ 6.1
Load THERMIX program	 →  →  →  → 	⇒ 6.4
Tune THERMIX program	 →  →  → 	⇒ 6.4
Plate or Tube Mixing	 →  →  →  → 	⇒ 6.4
Add favourite program	 →  →  →  →  → 	⇒ 7.1.1
Create new program	 →  →  →  →  → 	⇒ 7.1.2
Edit user-defined program	 →  →  →  → 	⇒ 7.1.3
Change program parameters	 →  →  →  → 	⇒ 7.1.3
Edit profiled program	 →  →  → 	⇒ 7.2
Delete user-defined program	 →  →  →  →  → 	⇒ 7.1.4

6.2 Attaching a Heated Module

The Heated Module is a self-contained precision-calibrated sample heater with integral anti-condensation lid. Each module is specifically designed for optimum sample heating within a particular plate or tube type. Please refer to the **Heated Module Instructions for Use** for specific usage details.



CAUTION

Always switch off the Ther-mix unit before attaching or removing the Heated Module. Do not touch the exposed electrical contacts on the unit or the underside of the Heated Module as this may impair their functionality.

To attach a Heated Module:

- 1) Switch off the unit and wait for the display to go blank.
- 2) Place the Heated Module on the Docking Platform ensuring that it is sitting flat and correctly positioned on the two location dowels.
- 3) Using the supplied hex-driver, screw the module to the platform (refer to the **Heated Module Instructions for Use** for full details).
- 4) For modules with a lid, always keep the lid closed when not accessing the fixing screws or sample plates and tubes.
- 5) Switch the unit back on, the display should light up and display the splash screen.

With the module attached, the **Heater** tab will show the module type (HMnn) and short description, as well as the current block and lid temperatures.

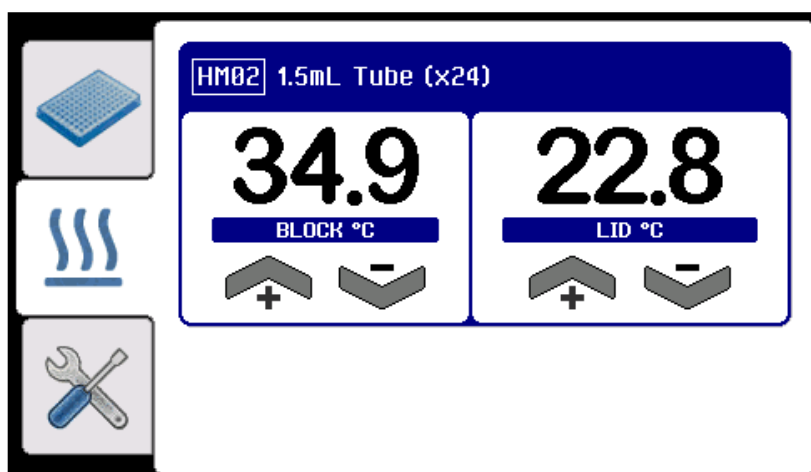

The block and lid heaters will not be enabled until a mixing and heating program has been selected and loaded (see section 6.4).

6.3 Unit Shutdown Procedure

After use, and before switching off the power to the unit, ensure that any plate or tubes have been removed from the Heated Module, then put the unit into standby mode as described in section 7.3.5.

6.4 Mixing with Flexible User Parameters

The first program in the selection grid list is always the flexible **THERMIX** program. This is a special program which allows the user to freely change the mixing speed, time and temperature parameters to suit their immediate needs.

The mixer speed can be set between 200 RPM and 3000 RPM; the time between 5 seconds and 28 days; and the block temperature up to 99.9°C.

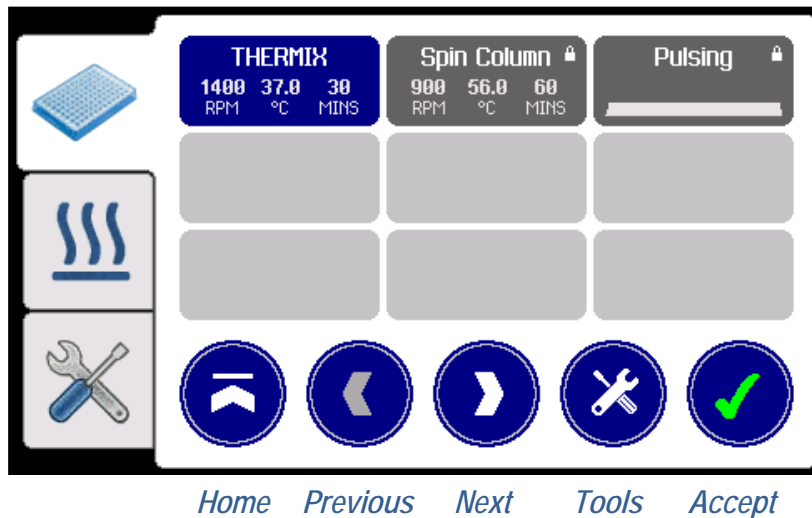

To load the **THERMIX** program, first attach a Heated Module to the unit, then select the **Mixer** page tab, and press the **Home** button, followed by the **Accept** button.

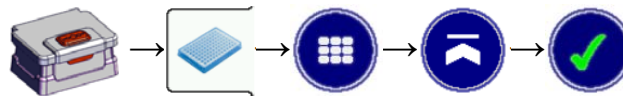

The display now shows the current program speed and time parameters, which can be manually changed using the **Increase** and **Decrease** buttons below the speed and time values.

For the THERMIX program only, these settings can even be changed when the mixer is running to fine tune the mixing performance.

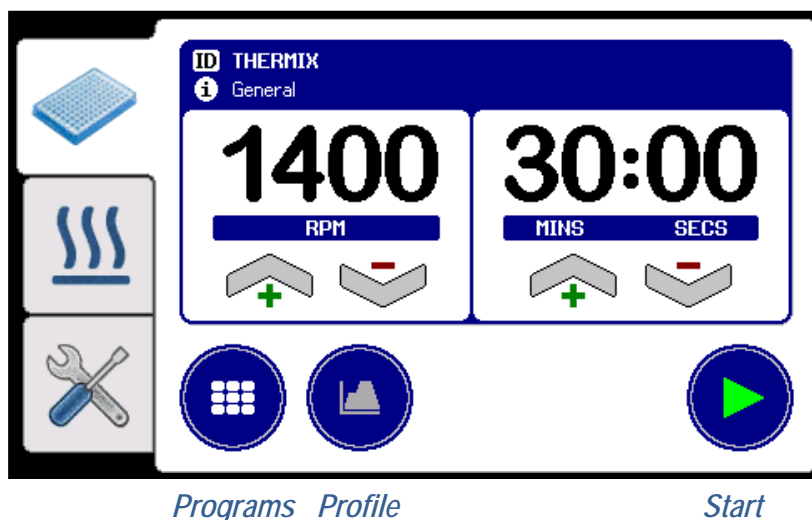

The block and lid heaters will also be switched on at this point and begin to control to the specified temperature set points. The progress can be checked, or the set points modified, by selecting the **Heater** page tab.

The display shows the current block and lid temperatures, as well as their set-point temperatures which can be manually changed using the **Increase** and **Decrease** buttons below the block and lid temperature values.

For the THERMIX program, the temperature settings can also be changed whilst the mixer is running to fine tune the heating performance.

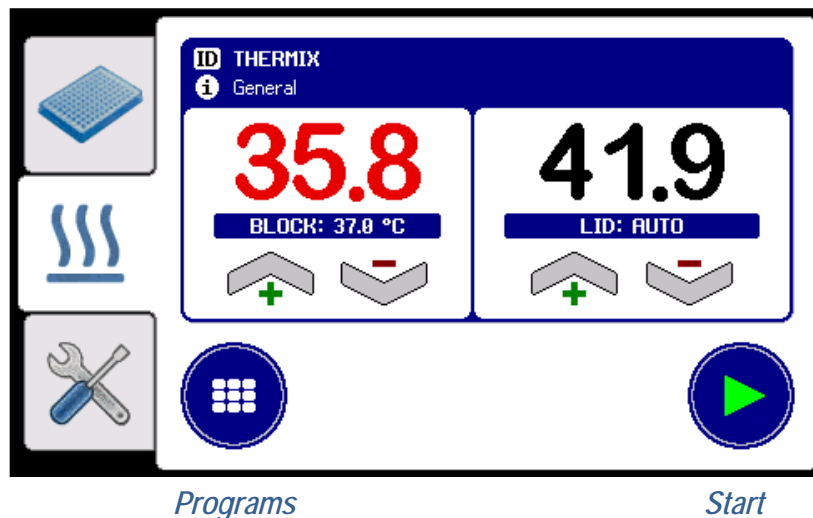

The block and lid heater temperatures will be highlighted in red until they are within 0.2 °C of their set-points.

When the heaters are enabled, the block and lid set-point temperatures are displayed in the bars below the large heater temperature readout digits.

BLOCK: 37.0 °C

LID: AUTO



For the THERMIX program, the **Increase** and **Decrease** buttons are always enabled, allowing the speed, time and temperature parameters to be freely changed. Any changes to the program settings are automatically saved to memory.

The possible temperature set-point and display readout values are listed in Table 7 below.

Table 7: Temperature Set-point and Readout

Value	Meaning
--.-	Heated Module not attached to the unit or the lid heater is not available on that Heated Module type
OFF	Heater disabled
AUTO	Lid heater automatically set to 5°C above the block temperature
5.0 to 99.9	Block heater temperature range (see note below)
5.0 to 105.0	Lid heater temperature range (see note below)



NOTE

Please note that the Block and Lid temperature control ranges may vary depending on the Heated Module being used. Please refer to the **Heated Module Instructions for Use** for full details.

Once the block and lid have reached the desired temperature, insert the tubes or plate into the Heated Module and securely close the lid.



WARNING

Injury can occur from flying tubes or plates if they are not correctly inserted or the lid is not securely closed, or if the maximum recommended mixing speed or fill volume is exceeded. Refer to **Heated Module Instructions for Use** for full limitations.

Injury or contamination may also occur from sample material being expelled from tubes or plates whilst mixing. Always use closed tubes and sealed plates, and wear appropriate Personal Protective Equipment (PPE).

With the Heated Module lid securely closed, press the **Start** button to begin the mixing process.



Please note that the mixer will not operate until the Heated Module lid has been closed. If the lid is opened during operation, mixing will be aborted and an E26 error reported (see section 8).

The mixing timer will now count down each second until it reaches zero, or the **Stop** button is pressed.

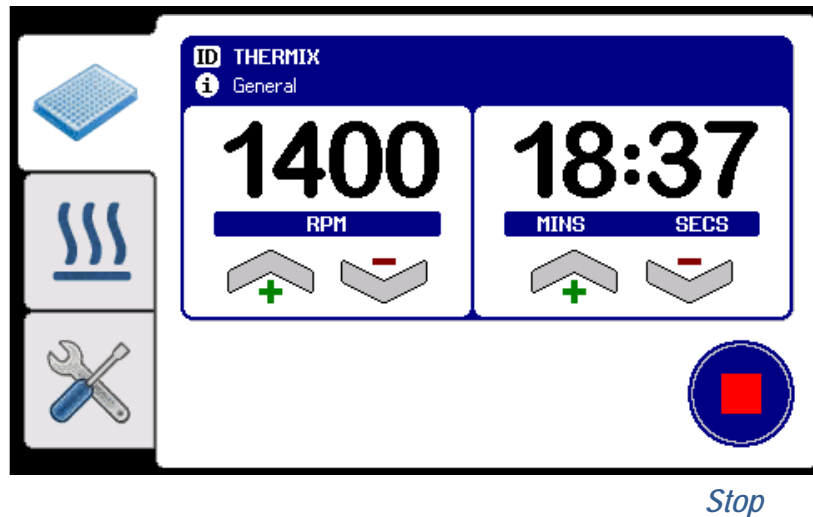

The Ther-mix unit has a vibration sensor which detects if the mixer becomes unstable, and automatically decreases the mixing speed (displaying the new RPM in red) to reduce the vibration. If there is still too much vibration, mixing is aborted and an E25 error displayed. See Table 16 for error code descriptions.

When mixing is complete, the unit beeps three times and the mixer will stop although the heaters will continue to control to their specified set-points.



The volume of the beeps at the end of the mixing process can be adjusted from the user **Preferences** page (see section 7.3.1).

Open the Heated Module lid and carefully remove the tubes or plate, taking extreme care as the heated lid and block will still be hot. Close the module lid when finished to retain the heat and for heating optimum performance.

The display will return to the previous screen, ready to perform the next mixing operation.

Pressing the **Programs** button will switch off the heaters and return the display to the program selection screen.

6.5 Pre-defined Mixing Programs

The unit is supplied with up to eight pre-defined (🔒) mixing programs which support commonly used mixing and heating protocols.

i Other mixing speeds and times can be selected using the flexible THERMIX program (see section 6.4) or by creating a new user-defined program (see section 6.6 for details).

The procedure for mixing using a pre-defined program is similar to that described in section 6.4 for the THERMIX program.

First attach the Heated Module, then select the appropriate pre-defined program from the selection grid and press the **Accept** button to load it.

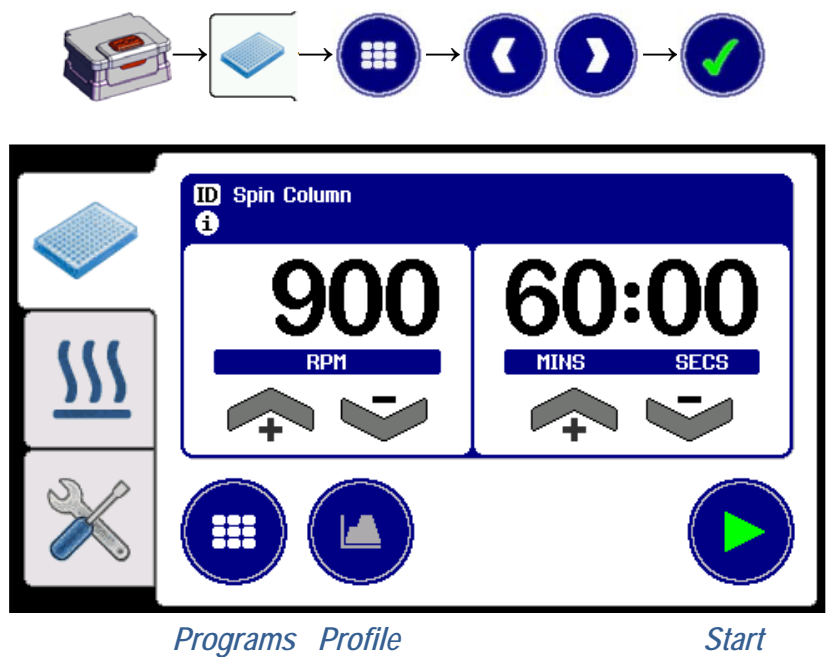

i For pre-defined programs, the **Increase**, **Decrease** and **Profile** buttons are always disabled to prevent the program parameters from being modified. Refer to section 7.1.2 for details of creating user-defined variants of the pre-defined programs.

Place the tubes or plate in the Heated Module, ensuring they are fully and correctly inserted, then securely close the module lid and press the **Start** button to begin the mixing process.

The mixing timer will count down each second until it reaches zero, or the **Stop** button is pressed.

When mixing is complete, the unit beeps three times and mixing stops. Remove the tubes or plate from the module and close the module lid.

The display will return to the previous screen, ready to accept the next batch of tubes or plate to be mixed. Alternatively, press the **Programs** button to return to the program selection screen.

6.6 User-defined Mixing Programs

The unit can store 91 user-defined mixing programs, which can be created by copying an existing program and then changing the program ID, and the speed, time and temperature parameters as required. See section 7.1.2 for details.

User-defined mixing programs can also consist of a series of individually defined program steps, each with different mixing and heating parameters and run in succession to produce a complex profiled mixing sequence. Refer to section 7.2 for details.

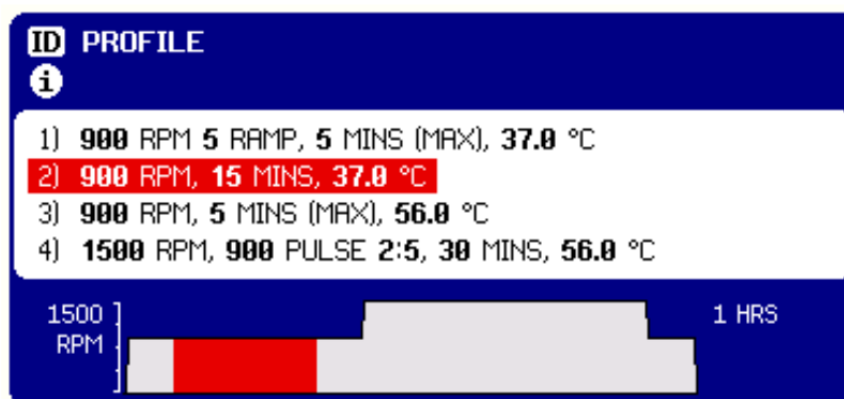

7 Advanced Program and Set-up Features

The Ther-mix unit also provides a number of advanced features which allow the user to optimise the unit’s performance to meet their particular needs.

7.1 Program Tools

As well as the pre-defined mixing programs, the user can create variants of any existing ones. This allows new programs to be developed and optimised for the specific sample assay, vessel type and fill volumes being used.

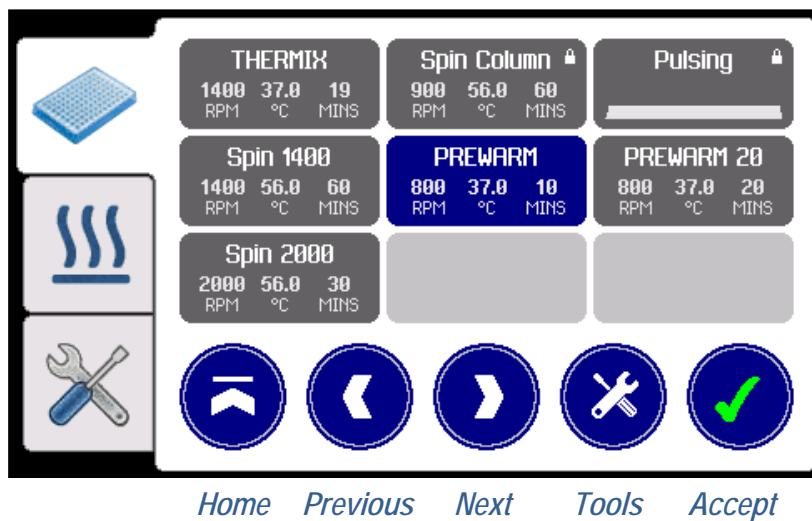



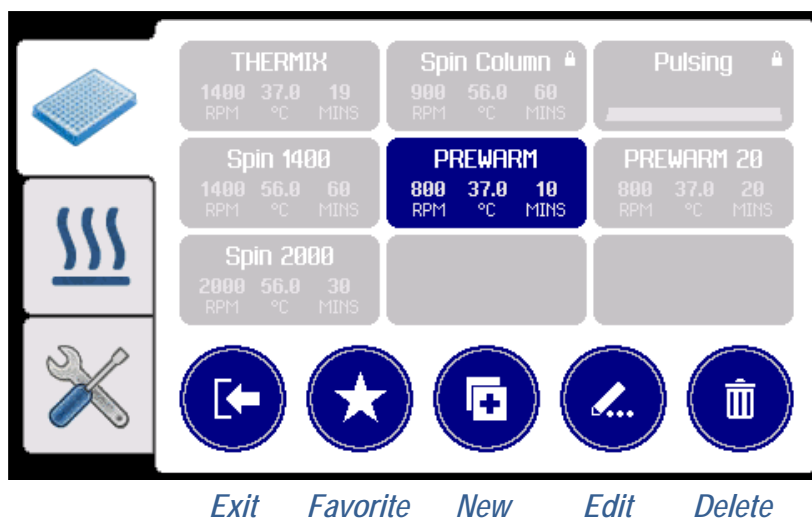

From the **Mixer** program selection tab, highlight the program to be copied or modified and then press the **Tools** button.



The tools menu function buttons are listed in Table 8 and explained in detail in the following sub-sections.

Table 8: Program Tools Options

	Exit to program selection screen	⇒ 7.1
	Add/remove program from Favourite list	⇒ 7.1.1
	Create a New copy of the selected program	⇒ 7.1.2
	Edit selected program details and parameters	⇒ 7.1.3
	Delete the selected program	⇒ 7.1.4

7.1.1 Favourite Programs List

Although the programs list can hold up to 100 pre-defined and user-defined programs, typically only a small number of these will be regularly used.

Thus, to help organise the full list, commonly used programs can be added to a favourites list, which always appear at the top of the program list.

To add a program to the favourites list, first highlight the program in the selection grid, then press the **Tools** button followed by the **Favourite** button. The program is then marked with a ★ symbol in the top corner and moved to the top of the list.



The program can be removed from the favourites list by repeating the same process.



The order of the programs within the favourites list is determined by the order in which they were created and cannot be individually rearranged.

7.1.2 Creating a New User-defined Program

The unit can hold up to 100 mixing and heating programs, 91 of which can be created and defined by the user.

To add a new program, highlight an existing program from the selection list which best matches the new program requirements, then press the **Tools** button followed by the **New** button.

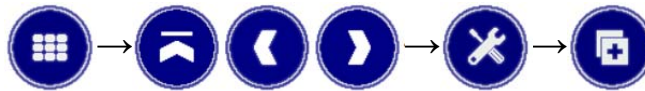

The **New** button is unavailable when **Protected** mode is enabled. See section 7.3.4 for details.

This will create a copy of the selected program and pop-up the program ID editing keyboard:

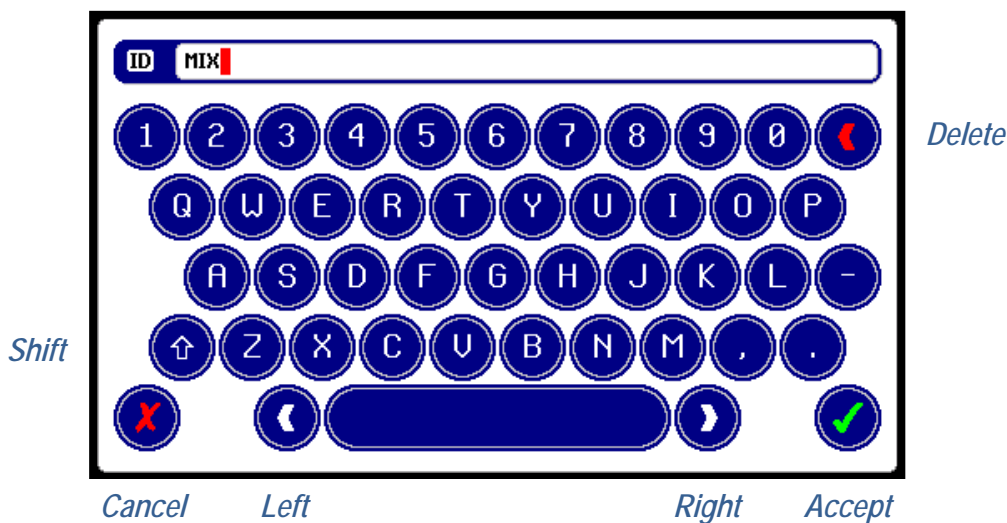

Use the QWERTY keyboard to enter a new unique program ID, and then press the **Accept** button.



Try to limit the program ID to about 10 characters, as longer names are displayed truncated in the program selection grid.

The new program has now been created and saved to memory, and can be further modified using the editing functions described in section 7.1.3.

7.1.3 Changing the Program ID, Info and Parameters

To modify an existing user-defined program, highlight the program in the selection grid, then press the **Tools** button followed by the **Edit** button.





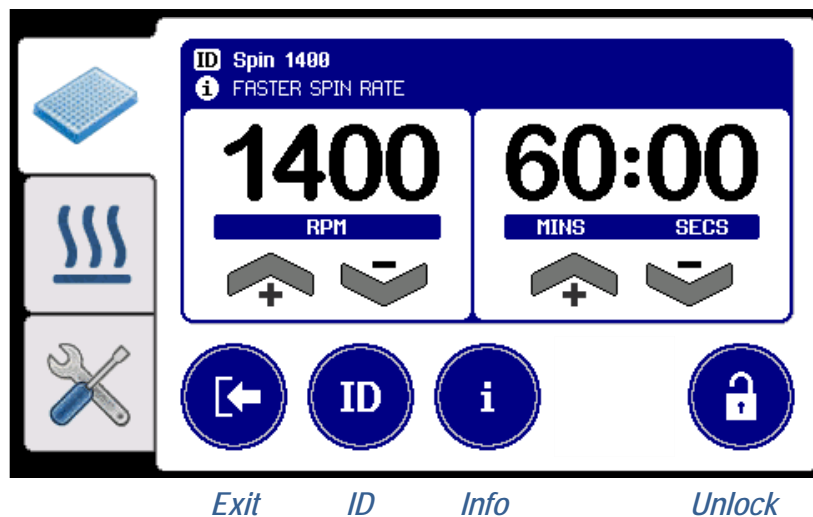

 The **Edit** button is unavailable when **Protected** mode is enabled. See section 7.3.4 for details.

The **Edit** menu provides three top-level program editing functions.



These editing functions allow the program **ID** and **Info** text, and program parameters to be changed, as described in Table 9.

Table 9: Program Editing Functions		
	Exit program editing menu	⇒ 7.1
	Edit the program ID using QWERTY keyboard, which can be between 1 and 20 characters long	⇒ 7.1.2
	Edit the optional program Info text, which can be up to 50 characters	
	Unlock the program to change the speed, time and temperature settings or define a profiled sequence	⇒ 7.2



The **Unlock** button will be disabled if no Heated Module is attached.

Pressing the **Unlock** button enables the speed, time and temperature **Increase** and **Decrease** buttons, and also the program **Profile** editor button.

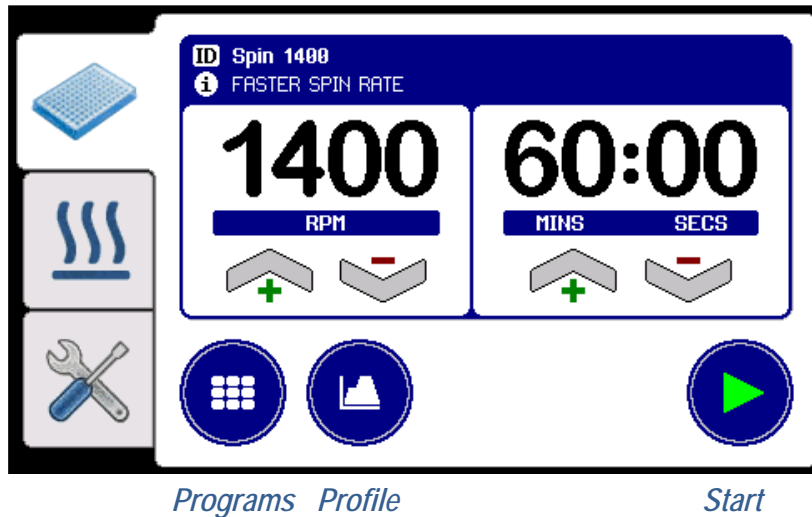

Once **Unlocked**, the **Increase** and **Decrease** buttons can be used whilst the mixer is running to fine tune the mixing performance for the particular plate type, sample solution and fill volume being used. Any changes to these parameters are automatically saved to memory for next time.

The block and lid heater set-point temperatures can also be changed using the **Increase** and **Decrease** buttons from the **Heater** page tab.

Pressing the **Profile** button brings up the advanced program profiling menu, which allows a sequence of up to 20 mixing parameter steps (speeds, times and temperatures) to be defined. Refer to section 7.2 for details.

7.1.4 Deleting a User-defined Program

To permanently delete a user-defined program, highlight the program in the selection grid, then press the **Tools** button followed by the **Delete** button.



The **Delete** button is unavailable when **Protected** mode is enabled. See section 7.3.4 for details.

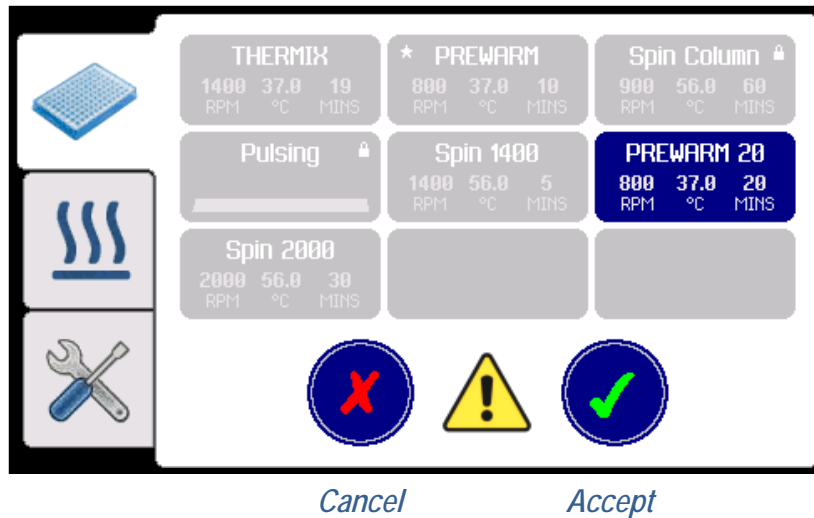

Next press the **Accept** button to confirm the deletion, or **Cancel** to exit.

7.2 Profiled Mixing Programs

The Ther-mix can store 91 user-defined mixing programs, each of which can consist of a sequence of up to 20 individual mixing and heating steps. For each profile step, the user can specify the speed, time and temperature parameters (as detailed in Table 11).

Hence, an example profiled program could consist of the following three steps:

- 1) 1000 RPM, 30 seconds, 5 second ramp
- 2) 2000 RPM, 60 seconds, 10 second ramp
- 3) 1600 RPM, 5 minutes, 5 second ramp

When the program is run, the unit executes each profile step in the sequence in turn, showing the overall progress on the profile chart.

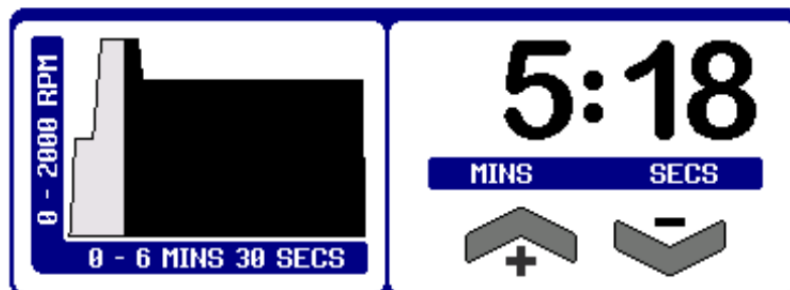

For profiled programs, the speed, time and temperature cannot be adjusted using the **Increase** and **Decrease** buttons. These parameters can only be altered via the **Profile** button.

To create a new profiled program, first create a new program as described in section 7.1.2 above.

Then from the program **Tools** menu, press the **Edit** button followed by the **Unlock** button to enable the **Profile** button, and then press the **Profile** button to display the profile editing screen.





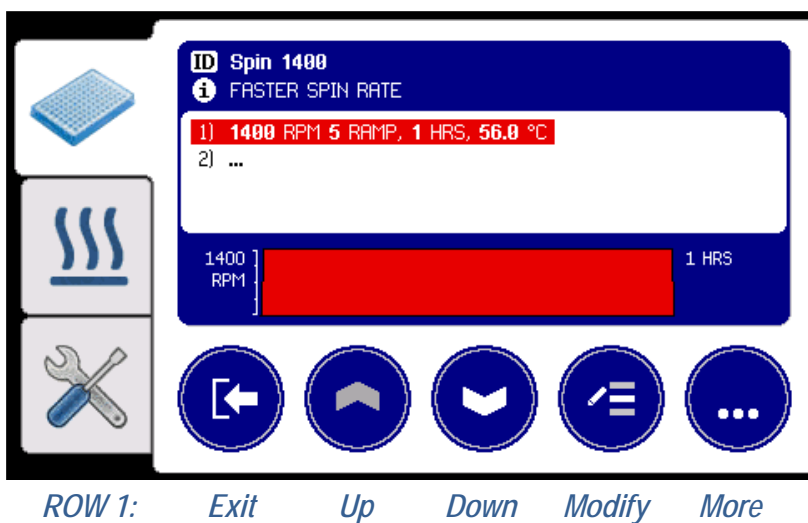



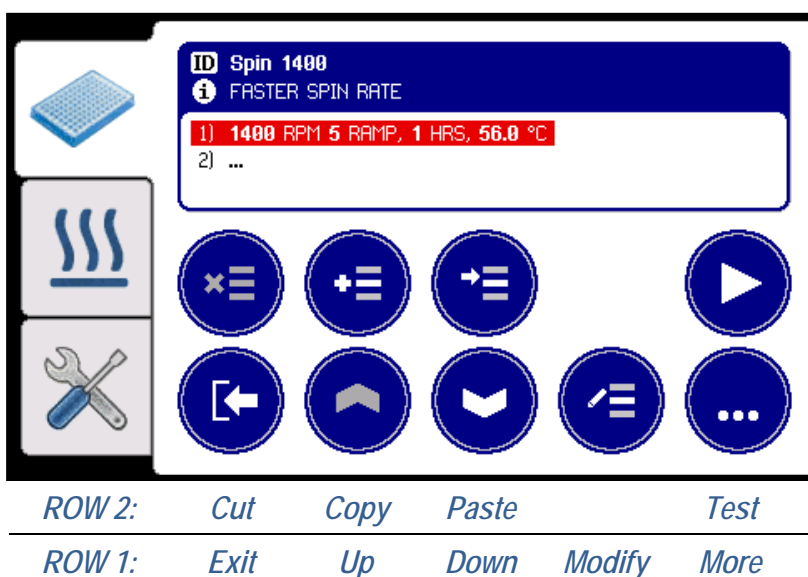

The **Profile** button accesses the profile editing menu, which consists of one or two rows of function buttons:



Press the **More** button to show or hide the second row of function buttons:



These button functions are described in Table 10 below.

Table 10: Profile Editing Buttons	
	Exit profile editing menu
	Move profile step cursor Up one line
	Move profile step cursor Down one line
	Modify profile step parameters at cursor position
	More to show or hide Row 2 menu buttons
	Cut and remove profile step at cursor position
	Copy profile step at cursor position
	Paste cut/copied profile step above cursor position
	Test run the mixer profile step at cursor position

Press the **Modify** button to change the 13 profile step parameters, spread over three tab pages (as listed in Table 11 below), using the numeric keypad to enter each new value followed by the **Accept** button.



The **Accept** button is also used to skip over unmodified values.

Table 11: Program Profile Step Parameters		
Parameter	Purpose	Range
SPEED	Mixing speed and pulsing mode	
RPM	Mixing speed *	200 to 3000* RPM
RAMP	Time allowed to smoothly transition between the previous speed and the new RPM value	0 to 60 seconds
PULSE DUTY1 DUTY2	Optional pulsing mode. Mixer pulses at specified PULSE speed for DUTY1 seconds then returns to normal RPM speed for DUTY2 seconds and repeats this cycle, giving a mark:space ratio of DUTY1:DUTY2	200 to 3000* RPM 0 to 60 seconds
TIME	Profile step duration	
DAYS HOURS MINS SECS	Mixing step duration specified in days, hours, minutes and/or seconds	5 seconds to 28 days
TEMP	Heater temperatures and transition mode	
BLOCK	Block temperature *	5 to 99.9°C
LID	Lid temperature *	5 to 105 °C
TRANS	Transition mode waits for up to the maximum specified TIME for the heaters to reach thermal stability, before continuing to the next step. Hence, the step duration will be ≤ TIME	Yes / No

PULSE mode allows the mixer to pulse between the normal running RPM speed and the specified PULSE speed. The duration and time between pulses is defined by DUTY1 and DUTY2 respectively. This mode is disabled when PULSE is set to NONE.

 *NOTE	Note that the available speed and temperature ranges may be limited by the Heated Module type being use. Please refer to the Heated Module Instructions for Use for specific details.
-----------------------------------------------------------------------------------------------------	----------------------------------------------------------------------------------------------------------------------------------------------------------------------------------------------

When all 13 values have been accepted, the display returns to the previous profile editing screen.

To enter a new step at the end of the sequence, move the cursor **Down** to the empty “...” line and press the **Modify** button. Enter the new step parameters as required, and then press the **Accept** button until all 13 values have been set.

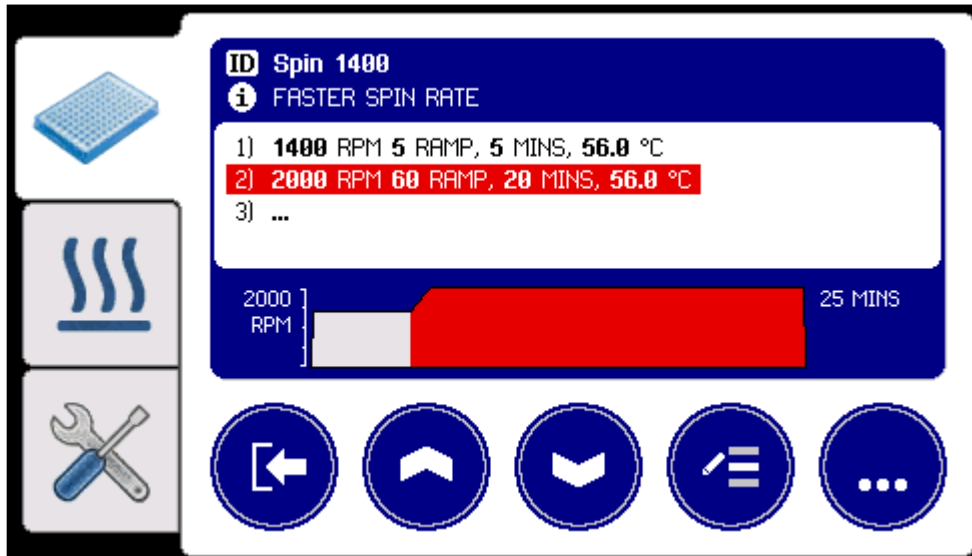

Repeat this process for up to 20 profiles steps.

The **Cut**, **Copy** and **Paste** functions can be used to delete, move and duplicate profile steps, as illustrated in Table 12.

















Table 12: Profile Editing Functions	
Desired Action	Button Sequence
Modify step parameters at current cursor position	Modify
Add a new step at end of list	Down..., Modify
Delete step at cursor position	Cut
Move step at cursor to before new cursor position	Cut, Up/Down, Paste
Duplicate step at cursor position	Copy, Paste
Insert duplicate step before new cursor position	Copy, Up/Down, Paste
Insert new step before cursor position	Copy, Paste, Modify

7.3 User Preferences and Options

The user **Preferences** page provides several options for customising the unit’s behaviour, and shows the current settings state.



The available options are shown in Table 13 and described in the more detail in the following sub-sections.

Table 13: User Preferences and Options				
Beeper volume				 ⇒ 7.3.1
	<i>Muted</i>	<i>Low</i>	<i>Medium</i>	<i>High</i>
Touchscreen button click volume				⇒ 7.3.1
	<i>Silent</i>	<i>Quiet</i>	<i>Loud</i>	
LCD backlight brightness level				⇒ 7.3.2
	<i>Dim</i>	<i>Normal</i>	<i>Bright</i>	
Cooling fan operating mode				⇒ 7.3.3
	<i>Off</i>	<i>Automatic</i>	<i>Continuous</i>	
Program set-up protection mode				⇒ 7.3.4
	<i>Disabled</i>	<i>Protected</i>		
Standby mode				⇒ 7.3.5
	<i>Standby</i>			

To change a setting, press the associated option button, then select the new value, and press the **Accept** button to save the new setting.

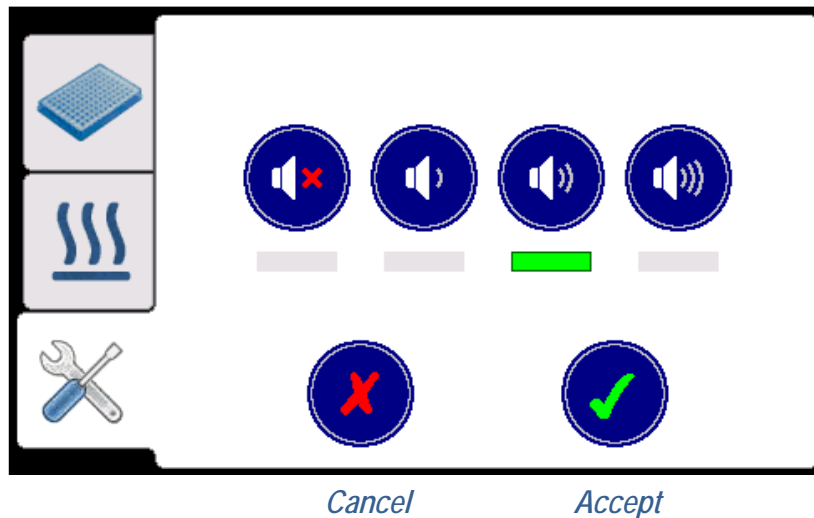

7.3.1 Beeper and Button Click Volume

The beeper sounds at the end of each mixing operation. This volume can be adjusted to suit the ambient sound conditions, or **Muted** altogether.

Likewise, the volume of the touchscreen button click can be independently adjusted, or set to **Silent**.

7.3.2 LCD Backlight Brightness Level

The LCD backlight brightness can be adjusted to suit different lighting conditions.

7.3.3 Cooling Fan Operating Mode

The unit's internal cooling fan draws air in from around the mixer platform and gently blows warm air out of the ventilation slots in the base of the unit.



It is recommended that the fan is set to either **Automatic** or **Continuous** mode.

7.3.4 Program Set-up Protection Mode

By default, the user is able to access all features and functions of the unit. However, once the unit has been installed and fully set-up, it may be

desirable to disable these programming functions to protect against accidental modification.

Enabling **Protected** mode hides the following function buttons:

Table 14: Protected Function Buttons	
	New, Edit, Delete
	Unlock, Profile
	Modify, Cut, Copy, Paste

To regain access to these functions, simply **Disable** protected mode again.

7.3.5 Standby Mode

Before turning off the unit, it is recommended to put it into standby mode by first removing any plate or tubes from the Heated Module, and then selecting the **Standby** option and pressing the **Accept** button.

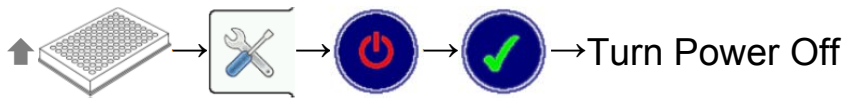

When the power to the unit is switched off or disconnected, the LCD may remain illuminated for several seconds before going blank.

8 Troubleshooting

For technical enquiries, please contact your distributor or Vitl at the address given on page 2 of this manual.

Table 15: Troubleshooting Suggestions

Unit will not Turn On	
• No power → <i>Check power is switched on at wall outlet socket and rear of unit</i>	⇒ 5
• Bad mains connection → <i>Ensure power connector fully inserted into rear of unit</i>	⇒ 5
• Unit fuse blown → <i>Consult a qualified engineer</i>	⇒ 9.1
Unit Spuriously Resets or Restarts Automatically	
• Power connector loose → <i>Ensure connector fully inserted at rear of unit</i>	⇒ 5
• Supply brown-outs or black-outs → <i>Power unit from a stable AC mains supply</i>	⇒ 11
Unit does not recognise Heated Module	
• Loose connection → <i>Ensure that the Heated Module is fully screwed down</i>	⇒ 6.2
Mixer will Not Operate	
• No module → <i>Attach a Heated Module to the unit</i>	⇒ 6.2
• Lid open → <i>Ensure that the Heated Module Lid is securely closed</i>	⇒ 6.4
Block does Not reach Set-point Temperature	
• Set-point too low or too close to room ambient temperature → <i>Increase set-point</i>	⇒ 6.4
Lid does Not reach Set-point Temperature	
• Set-point too low → <i>Increase set-point</i>	⇒ 6.4
• Set-point below the block heater temperature → <i>Use AUTO mode</i>	⇒ 6.4
Condensation forming on Tube Caps	
• Lid not up to temperature → <i>Wait for heaters to stabilise before inserting samples</i>	⇒ 6.4
• Lid temperature too low → <i>Use AUTO mode or set lid temperature higher</i>	⇒ 6.4
Mixer will Not run at Required Speed	
• Unstable working surface → <i>Ensure installed on a solid, stable and level surface</i>	⇒ 5
• Incompatible module → <i>Check Heated Module specification</i>	⇒ 6.2
Mixing Ineffective or Not as Expected	
• Mixing speed too slow → <i>Increase mixing speed for optimum performance</i>	⇒ 6.4
• Mixing time too short → <i>Increase mixing time to ensure adequate mixing</i>	⇒ 6.4
• Lid wetting or sample leakage → <i>Reduce mixing speed or fill volume</i>	⇒ 6.4

If the software detects a problem with the unit, it displays the following error popup showing one of the error codes listed in Table 16.





If the problem persists, please contact your distributor or Vitl for assistance, quoting the error code and the 20-digit report code.

Table 16: Unit Error Codes

Code	Meaning	Suggested Remedy
E10	User Preferences not set	Review option settings and adjust as required ⇒ 7.3
E20 E21 E22	Mixer mechanism fault	Contact distributor for further assistance ⇒ 10
E23 E24	Mixer overloaded or jammed	Switch off unit and inspect plate holder for obstructions ⇒ 9.2
E25	Mixing load unbalanced	Ensure unit correctly installed on solid working surface ⇒ 5
		Ensure maximum speed and load weight limits are observed ⇒ 11
E26	Heated Module lid opened	Do not open the lid whilst the mixer is running or still moving ⇒ 6.4
E50	Heated Module interface fault	Turn off unit, remove Heated Module and leave for 5 minutes. Then refit module and screw securely to unit (see section 6.2). Turn unit back on. ⇒ 6.2
E51	Heated Module block fault	
E52	Heated Module lid fault	
E53	Heated Module over temperature	
E54	Heated Module removed	Only remove the Heated Module when the unit power is off ⇒ 6.2
All others	Internal unit fault	Contact distributor for further assistance ⇒ 10

9 Maintenance and Servicing

Although the Ther-mix unit does not require any scheduled servicing, the operator should regularly clean and inspect the unit for defects, as described in section 9.2 below.

 DANGER	Please observe and comply with all of the Unit Maintenance and Serviceability safety precautions listed in section 2.
 WARNING	Never remove the unit casework. There are no user or operator serviceable parts inside the unit. Always switch off and unplug the unit before performing any cleaning or disinfecting tasks.
 CAUTION	Practise anti-static precautions by avoiding directly touching the exposed electrical contacts or using statically charged cleaning cloths.

For technical and service related enquiries, please contact your distributor or Vitl at the address given on page 2 of this manual.

9.1 Replacing the Unit Fuse

The unit fuse should only be replaced by a suitably qualified engineer.

 DANGER	The unit fuse will only blow as a result of an internal unit fault. This fuse should only be changed after the unit has been thoroughly inspected by a qualified engineer, and must be replaced with the exact type specified in section 11.
------------------------------------------------------------------------------------------------------	----------------------------------------------------------------------------------------------------------------------------------------------------------------------------------------------------------------------------------------------

Thoroughly inspect the unit for any signs of damage, loose components or liquid spillage or ingress. If in doubt, please contact Vitl on the number given on page 2 of this manual.

**DANGER**

The fuse holder is removed by disconnecting the mains power cord and then using a flat bladed screwdriver to carefully pry open the fuse access cover and ease out the fuse holder.

After replacing the fuse with an identically rated fuse (see section 11), push the fuse holder firmly back into the inlet module and close the access cover.

The unit must be electrically safety tested for excess leakage current before being repowered from the mains supply.

9.2 Routine Cleaning and Inspection

The unit casework should be cleaned and inspected at regular intervals, and whenever contamination or spillage occurs, as follows:

1. Switch off the unit and disconnect the power before performing any inspection checks or cleaning.
2. Before cleaning, remove the Heated Module and inspect the unit casework and docking platform for any signs of wear, damage, cracks or other defects.
3. Use a dry linen cloth or cotton bud to remove any dirt build-up on or around the electrical contacts of the Heated Module interface port. Do not wet these contacts as this will cause corrosion and malfunction.
4. Wearing suitable PPE, clean the casework using a damp cloth or cotton bud soaked with a suitable disinfectant solution (such as Virkon). Do not over wet.
5. Clean the Heated Module docking platform, paying particular attention to the gap between the platform and the casework to remove any build-up of debris – avoiding pushing it into the unit.
6. Clean along the spill gutter strip at the rear of the unit.
7. Clean around the LCD fascia and touchscreen, taking care to avoid over wetting or pushing debris into the bezel gap.
8. Check that the ventilation slots on the base of the unit are clear of dust and fluff build-up.
9. Check and carefully clean the Heated Module (refer to separate **Heated Module Instructions for Use** for details). Do not wet the electrical contacts on the base.

**DANGER**

After cleaning, ensure that the unit is thoroughly dry, especially around the mains power inlet, before reconnecting the power cord and switching the unit on.

9.3 Decontamination Procedure

The unit and accessories should be decontaminated using the following procedure before being stored or transported.

Certificate of Decontamination

We respect the health and safety of our clients and employees, and request that any products or accessories being returned are decontaminated in accordance with the procedure below.

1. Decontamination Procedure

Thoroughly clean all outside surfaces of the product (including any accessories, power cords, manuals, packaging, etc) with a damp cloth soaked with suitable disinfectant solution (such as Virkon).

Allow to dry fully before packing.

2. Decontamination Declaration

Company Name: _____

Address: _____

Product Code: Ther-mix

Serial Number: _____

Reason For Return: _____

Where Product Used: _____

Please tick the appropriate option(s) below:

I certify that I have decontaminated the product as per the above procedure.

Decontaminant Used: _____

I certify that the product has not been exposed to any chemical or biological materials.

Title: _____ Name: _____

Signature: _____ Date: _____

Telephone: _____ Email: _____

9.4 Transportation and Storage

The Ther-mix unit and its accessories should be thoroughly decontaminated using the procedure detailed in section 9.3 before being placed in its original packaging for transportation or storage.



WARNING

Refer to section 11 for the acceptable range of Storage and Transportation environmental conditions.

Always ensure that the unit and accessories are completely dry and free of any condensation before being packed.

9.5 Product Disposal

At end-of-life, this product must be disposed of in accordance with your local authority regulations for the disposal of potentially hazardous waste and electronic equipment.

The unit and its accessories should be decontaminated using the procedure detailed in section 9.3 before disposal or shipping.



Do not dispose of this product into unsorted municipal waste or public landfill.

Please contact your distributor (or Vitl at the address on page 2 of this manual) for details of how to correctly dispose of this product.

10 Warranty and Returns

Integrated Technologies Limited (ITL) warrants the Ther-mix product, when purchased new and installed and operated in accordance with the instructions of this manual, to be free from defects in materials and workmanship, and will repair or replace, at their discretion, any unit or accessory which exhibits such defects.

In no event will ITL be liable for any indirect, incidental or consequential damages resulting from any defect or warranty claim.



NOTE

Unspecified use or unauthorised modification of any part of the Ther-mix unit or its accessories or the use or attachment of any adaptor or peripheral not supplied, specified or sanctioned by ITL will invalidate this warranty.

This warranty is provided to the original purchaser of the product for one year from the date of purchase.

Under the terms of this warranty, the product must be returned in its original packaging, transportation prepaid by the sender, with a copy of the Proof of Purchase and a detailed description of the problem.



WARNING

The product must be decontaminated using the procedure detailed in section 9.3 and a Certificate of Decontamination supplied with any return. If the product is considered too hazardous to be shipped, please contact Vitl on the number given on page 2 of this manual for further instructions.

Please contact your distributor (or Vitl on the number given on page 2 of this manual) to receive authorisation to return the product.

11 Technical Specification

Physical Unit Properties

Dimensions (W x D x H)	190 mm x 350 mm x 170 mm
Weight (excluding module)	8 kg

Mains Supply

Power Cord Rating	IEC C13, 3-Core, 5A min
Inlet Module Type	IEC C14, DPST, Single Fuse
Supply Voltage Range	100 to 240 VAC \pm 10%
Supply Frequency Range	50 to 60 Hz \pm 5%
Power Consumption	180 W max
Fuse Rating and Size	T2.5H 250V 20x5mm

Operating Environment

Temperature Range	+10 to +38 °C
Relative Humidity Range	20% to 85% non-condensing
Maximum Operating Altitude	2000 m above sea-level

Storage and Transportation

Temperature Range	-10 to +50 °C
Relative Humidity Range	20% to 95% non-condensing

Plate Mixer Rating

Eccentric Mixing Orbit	3 mm diameter
Maximum Speed Range	200 to 3000 RPM
Time Range	5 seconds to 28 days

Block Heater Rating

Temperature Range	Ambient + 5 °C to 99.9 °C
-------------------	---------------------------

Lid Heater Rating

Temperature Range	Block + 2 °C to 105 °C
-------------------	------------------------

12 Glossary of Terms and Abbreviations

ANSI	American National Standards Institute
Deepwell Plate	Plate with an SBS footprint featuring 48, 96 or 384 wells with a larger volume than microplates
DWP	Deepwell plate
EMC	Electro-Magnetic Compatibility
Incubate	Keeping an organism, cell or cell culture at the optimum temperature for growth and development
Microtiter Plate	Plate with an SBS footprint featuring 24, 48, 96 or 384 wells
Mixing Load	All samples to be mixed located in their respective tubes or plates
MTP	Microtiter plate
PCR	Polymerase Chain Reaction
Pellet	A small densely packed mass. Created, for example, via the centrifugation of a suspension
PPE	Personal Protective Equipment
Re-suspending	Dissolving a pellet by vortexing in a liquid with the material being redistributed in the liquid
RPM	Revolutions Per Minute
SBS	Society for Bio molecular Screening
Semi-skirted PCR Plate	PCR plate with an outer surrounding half edge
Skirted PCR Plate	PCR plate with an outer surrounding edge
Un-skirted PCR Plate	PCR plate without an outer surrounding edge
Well	A single cavity in a Microtiter plate, PCR plate or Deepwell plate