



Sigma 2-7

Sigma 2-7 IVD

from serial no. 157336



Laboratory centrifuge

Operating Manual

Please retain for later use!

In case of inquiries, please state the following numbers:

Order number:

Serial number:

© Copyright by
Sigma Laborzentrifugen GmbH
An der Unteren Söse 50
37520 Osterode am Harz
Germany

Tel.: +49 (0) 5522 / 5007-0
Fax: +49 (0) 5522 / 5007-12
Web: www.sigma-zentrifugen.de
E-mail: info@sigma-zentrifugen.de

1	General information	9
1.1	Importance of the operating manual	9
1.2	Intended use	9
1.3	Warranty and liability	9
1.4	Copyright	10
1.5	Standards and regulations	10
1.6	Scope of supply	10
2	Layout and mode of operation	11
2.1	Layout of the centrifuge	11
2.1.1	Functional and operating elements	11
2.1.2	Name plate	12
2.2	Mode of operation	13
2.2.1	Centrifugation principle	13
2.2.2	Area of application	13
2.2.2.1	Speed, radius, and relative centrifugal force	14
2.2.2.2	Density	14
3	Safety	15
3.1	Marking of the unit	15
3.2	Explanation of the symbols and notes	16
3.3	Responsibility of the operator	17
3.4	Operating personnel	17
3.5	Informal safety instructions	17
3.6	Safety instructions	18
3.6.1	Electrical safety	18
3.6.2	Mechanical safety	18
3.6.3	Fire prevention	19
3.6.4	Chemical and biological safety	19
3.6.5	Safety instructions for centrifugation	20
3.6.6	Resistance of plastics	20
3.6.7	Service life of rotors and accessories	21
3.7	Safety devices	21
3.7.1	Lid lock device	21
3.7.2	Standstill monitoring system	21
3.7.3	System check	22
3.7.4	Earth conductor check	22
3.8	Measures in the event of hazards and accidents	22
3.9	Remaining hazards	22
4	Storage and transport	23
4.1	Dimensions and weight	23
4.2	Storage conditions	23
4.3	Notes on transport	23
4.4	Packaging	24
4.5	Transport safety device	24

Table of contents

5	Set-up and connection	25
5.1	Installation site	25
5.1.1	Type of connection	25
5.1.2	Customer-provided fuses	25
6	Using the centrifuge	26
6.1	Initial start-up	26
6.2	Switching the centrifuge on	26
6.2.1	Opening and closing the lid	26
6.2.2	Installation of rotors and accessories	27
6.2.2.1	Installation of the rotor	27
6.2.2.2	Installation of accessories	28
6.2.2.3	Adapters	29
6.2.2.4	Tubes	29
6.3	Control System "Spincontrol Basic"	30
6.3.1	User interface	30
6.3.2	Display	30
6.3.3	Starting a centrifugation run	31
6.3.4	Interrupting a centrifugation run	31
6.3.5	Interrupting a deceleration process	31
6.3.6	Speed / Relative centrifugal force (RCF)	31
6.3.6.1	Changing the speed/RCF value during centrifugation	31
6.3.7	Runtime	32
6.3.7.1	Changing the runtime during centrifugation	32
6.3.7.2	Short run	32
6.3.7.3	Continuous run	33
6.3.8	Rotor selection	33
6.3.9	Softstart and softstop function	34
6.3.10	Automatic lid opening function	34
6.3.11	Start delay ("Clotting time")	34
6.3.12	Sound signal	35
6.3.13	Button signal	35
6.3.14	Button lock	35
6.3.15	Programs	36
6.3.15.1	Saving the current settings	36
6.3.15.2	Calling up stored programs	36
6.4	Switching the centrifuge off	36
7	Malfunctions and error correction	37
7.1	General malfunctions	37
7.1.1	Emergency lid release	38
7.2	Table of error codes	39
7.3	Service contact	40

Table of contents

8	Maintenance and service	41
8.1	Maintenance	41
8.1.1	Centrifuge	41
8.1.2	Accessories	42
8.1.2.1	Plastic accessories	42
8.1.3	Rotors, buckets and carriers	43
8.1.4	Glass breakage	43
8.2	Sterilisation and disinfection of the rotor chamber and accessories	44
8.2.1	Autoclaving	45
8.3	Service.....	46
8.4	Return of defective parts.....	47
9	Disposal	49
9.1	Disposal of the centrifuge.....	49
9.2	Disposal of the packaging	49
10	Technical data	50
10.1	Ambient conditions.....	51
10.2	Technical documentation	51
11	Appendix	52
11.1	Range of accessories	52
11.1.1	Rotor radii.....	53
11.2	Speed-gravitational-field-diagram	54
11.3	Table of the service life of rotors and accessories.....	55
11.4	Resistance data	56
11.5	EC declaration of conformity	61
12	Index	65

Table of contents

1 General information

1.1 Importance of the operating manual

A fundamental requirement for the safe and trouble-free operation of the centrifuge is to be familiar with the fundamental safety instructions and all possible hazards.

The operating manual includes important information concerning the safe operation of the centrifuge.

This operating manual and, in particular, the notes on safety and hazards must be observed by all persons operating the centrifuge.

In addition, the local rules and regulations for the prevention of accidents must be complied with.

1.2 Intended use

The laboratory centrifuge is suitable for the separation of constituents of different densities in mixtures with a maximum density of 1.2 g/cm³.

The laboratory centrifuge that is marked with IVD is intended for human biological samples, including donated blood and tissue, in conjunction with diagnostic in-vitro applications. This means that it is a medical product in accordance with the IVD directive 98/79/EC.

Only trained, specialised personnel are authorised to use the centrifuge in closed laboratories.

The intended use also includes:

- observation of all of the notes and instructions that are included in the operating manual and
- compliance with the inspection and maintenance instructions.

Sigma Laborzentrifugen GmbH cannot be held liable for any damage resulting from non-compliance.

1.3 Warranty and liability

The warranty and liability are subject to our "General Conditions" that were distributed to the operator upon the conclusion of the contract.

Warranty and liability claims are excluded if they are due to:

- improper use.
- non-compliance with the safety instructions and hazard warnings in the operating manual.
- improper installation, start-up, operation, or maintenance of the centrifuge.

1 General information

1.4 Copyright

The copyright concerning the operating manual remains with Sigma Laborzentrifugen GmbH.

The operating manual is solely intended for the operator and their personnel. It includes instructions and information that must not be

- duplicated,
- distributed, or
- communicated in any other way.

Non-compliance may be prosecuted under criminal law.

1.5 Standards and regulations

EC declaration of conformity
(see chapter 11.5 - "EC declaration of conformity")

1.6 Scope of supply

The centrifuge comprises:

- | | |
|-----------------------------------------------|----------------------------------|
| • 1 connection cable with IEC C13 connector | depending on the voltage variant |
| • 1 socket wrench, size 4 (rotor) | Part no. 930 050 |
| • 1 socket wrench, size 6 (emergency release) | Part no. 930 056 |
| • 1 bottle of slushing oil | Part no. 70 104 |

Documentation:

Operating manual incl. EC declaration of conformity

Accessories

According to your order, our order confirmation, and your delivery note.

2 Layout and mode of operation

2.1 Layout of the centrifuge

2.1.1 Functional and operating elements

- 1 Lid
- 2 Display
- 3 User interface
(see chapter 6.3.1 -
"User interface")



Fig. 1: Total view of the centrifuge

- 4 Fuse holder
- 5 Mains power switch
- 6 Name plate
(see chapter 2.1.2 -
"Name plate")
- 7 Mains power input



Fig. 2: Rear view of the centrifuge (example)

2 Layout and mode of operation

2.1.2 Name plate

- 1 Manufacturer and registered office
- 2 Type
- 3 Serial number
- 4 Max. speed
- 5 Max. kinetic energy
- 6 Max. density
- 7 Nominal voltage
- 8 Input fuse
- 9 Symbol for special disposal (see chapter 9 - "Disposal")
- 10 CE mark in compliance with the directive 2006/42/EC
- 11 Part number
- 12 Year of manufacture
- 13 Power consumption



Fig. 3: Example of a name plate

2.2 Mode of operation

2.2.1 Centrifugation principle

Centrifugation is a process for the separation of heterogeneous mixtures of substances (suspensions, emulsions, or gas mixtures) into their components. The mixture of substances, which rotates on a circular path, is subject to centripetal acceleration that is several times greater than the gravitational acceleration.

Centrifuges use the mass inertia inside the rotor chamber for separating the substances. Due to their higher inertia, particles or media with a higher density travel outwards. In doing so, they displace the components with a lower density, which in turn travel towards the centre.

The centripetal acceleration of an object inside a centrifuge, as the effect of centripetal force, depends on the distance between the object and the axis of rotation as well as on the angular velocity. It increases linearly as a function of the distance with regard to the axis of rotation and quadratically as a function of the angular velocity. The bigger the radius in the rotor chamber is and the higher the speed is, the higher the centripetal acceleration is. However, the forces acting on the rotor also increase.

2.2.2 Area of application

Depending on the area of application of the centrifuge and also on the particle size, solids content, and volume throughput of the mixture of substances that is to be centrifuged, there are different types of centrifuges.

The areas of application go from household use as a salad spinner or honey separator up to specialised technical applications in the clinical, biological, or biochemical context:

- For numerous clinical examinations, cellular material must be separated from the liquid to be analysed. The normal separation process can be sped up considerably by using laboratory centrifuges.
- In the metal-working industry, centrifuges are used for separating oil from metal cuttings. Dairies use centrifuges in order to separate cow's milk into cream and low-fat milk.
- Particularly big centrifuges are used in the sugar industry for separating the syrup from the crystalline sugar.
- Ultracentrifuges are predominantly used in biology and biochemistry in order to isolate particles, e.g. viruses. They are specifically designed for high speeds up to 500,000 rpm. The rotor moves in a vacuum in order to avoid air friction.

2 Layout and mode of operation

2.2.2.1 Speed, radius, and relative centrifugal force

The acceleration g , which the samples are subject to, can be increased by increasing the radius in the rotor chamber and by increasing the speed. These three parameters are interdependent and linked with each other via the following formula:

$$\text{Relative centrifugal force RCF} = 11.18 \times 10^{-6} \times r \times n^2$$

r = radius in cm

n = speed in rpm

RCF without any dimension

If two values are entered, the third value is determined by way of the stated formula. If, afterwards, the speed or the radius is changed, the resulting relative centrifugal force will be recalculated automatically by the control unit. If the RCF is changed, the speed will be adapted while the specified radius is maintained.

The speed-gravitational-field-diagram provides an overview of the relationship between speed, radius, and RCF (see chapter 11.2 - "Speed-gravitational-field-diagram").

2.2.2.2 Density

The laboratory centrifuge is suitable for the separation of constituents of different densities in mixtures with a maximum density of 1.2 g/cm^3 . All information concerning the speed of rotors and accessories refers to liquids with a density corresponding to this specification. If the density is above this value, the maximum permissible speed of the centrifuge must be reduced based on the following formula:













$$n = n_{\max} \times \sqrt{(1.2 / \text{Rho})}$$

Rho = density in g/cm^3

3 Safety

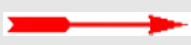
3.1 Marking of the unit

The following symbols are used for all types of centrifuges manufactured by Sigma:

	Dangerous voltage	I	On (Power)
	Hot surface	0	Off (Power)
	Caution! Risk of bruising		Name plate (see chapter 2.1.2 - "Name plate")
	Protective earth (ground)	CE	CE mark in compliance with the directive 2006/42/EC
	Earth (ground)		Do not dispose as part of domestic waste
	Unplug the mains plug		GS mark (tested safety; only for Germany)
	Arrow indicating the direction of rotation		NRTL mark (only for the USA and Canada)
	4°C Guarantee	IVD	Medical product in accordance with the IVD directive 98/79/EC (In-vitro diagnostica)
	Centrifuge with heating system		

3 Safety



NOTE

Safety indications on the centrifuge must be kept readable at all times. If necessary, they must be replaced.



NOTE

Not all of the symbols/labels are used for this centrifuge type.

3.2 Explanation of the symbols and notes

In this operating manual, the following names and symbols to indicate hazards are used:



DANGER

This symbol stands for a **direct** hazard to the life and health of persons.

Non-observance of these symbols **causes** serious health problems up to life-endangering injuries.



DANGER

This symbol stands for a **direct** hazard to the life and health of persons due to electrical voltage.

Non-observance of these symbols **causes** serious health problems up to life-endangering injuries.



WARNING

This symbol stands for a **potential** hazard to the life and health of persons.

Non-observance of these symbols **can** cause serious health problems up to life-endangering injuries.



CAUTION

This symbol indicates a potentially hazardous situation

Non-observance of these notes can cause minor injuries or damage to property.



NOTE

This symbol indicates important information.

3.3 Responsibility of the operator

The operator undertakes to authorise only trained, specialised personnel to work on the centrifuge (see chapter 3.4 - "Operating personnel").

The areas of responsibility of the personnel concerning the operation, maintenance, and care of the unit must be clearly defined.

The safety-conscious work of the personnel in compliance with the operating manual and the relevant EC health and safety directives, and the national laws concerning health and safety and the prevention of accidents must be checked at regular intervals (e.g. every month).

Under the international rules for health and safety at work, the operator is obliged to:

- take measures in order to prevent danger to life or health during work.
- ensure that the centrifuges are used properly and entirely as intended (see chapter 1.2 - "Intended use").
- take protective measures against fire and explosion when working with hazardous substances.
- take measures for the safe opening of the centrifuges.

3.4 Operating personnel

Only trained, specialised personnel are authorised to operate the unit. The persons operating the unit must

- be familiar with the fundamental health, safety, and accident prevention regulations.
- have read and understood this operating manual, in particular the safety sections and warning notes, and confirmed this with their signature.

3.5 Informal safety instructions

- This operating manual is a part of the product.
- The operating manual must be kept at the location of use of the centrifuge. Ensure that it is accessible at all times.
- The operating manual must be handed over to any subsequent owner or operator of the centrifuge.
- Any changes made must be added to the operating manual.
- In addition to the operating manual, the general and local rules and regulations concerning the prevention of accidents and the protection of the environment must also be supplied.
- Safety and danger indications on the centrifuge must be kept readable at all times. If necessary, they must be replaced.

3 Safety

3.6 Safety instructions

3.6.1 Electrical safety

To reduce the risk of electrical shock, the centrifuge uses a three-wire electrical cord and plug to connect the equipment to earth-ground. To preserve this safety feature:



DANGER

- Ensure that the wall socket is properly wired and grounded.
- Check that the mains voltage agrees with the nominal voltage listed on the name plate.
- Do not place vessels containing liquid on the centrifuge lid or within the safety distance of 30 cm around the centrifuge. Spilled liquids may get into the centrifuge and damage electrical or mechanical components.
- Work on the power supply system must only be performed by certified electricians.
- Inspect the electrical equipment of the unit regularly. Defects such as loose or burnt cables must be eliminated immediately.

3.6.2 Mechanical safety

In order to ensure the safe operation of the centrifuge, observe the following:



WARNING

- Do not open the lid when the rotor is in motion!
- Do not reach into the rotor chamber when the rotor is in motion!
- Do not use the centrifuge if it was installed incorrectly.
- Do not use the centrifuge without panels.
- Do not use the centrifuge if the rotors and inserts show signs of corrosion or other defects.
- Only use the centrifuge with rotors and accessories that have been approved by the manufacturer. In case of doubt, contact the manufacturer (see chapter 7.3 - "Service contact").
- Do not hold your fingers between the lid and the housing when closing the lid. Risk of crushing!
- Defective lid relieving devices could cause the centrifuge lid to fall (contact the service department, if necessary). Risk of crushing!
- Do not hit or move the centrifuge during its operation.
- Do not lean against or rest on the centrifuge during its operation.
- Do not spin any substances that could damage the material of the rotors and buckets of the centrifuge in any way. Highly corrosive substances, for example, damage the material and affect the mechanical strength of the rotors and buckets.
- Stop the centrifuge immediately in the event of a malfunction. Eliminate the malfunction (see chapter 7 - "Malfunctions and error correction") or inform the service department of the manufacturer (see chapter 7.3 - "Service contact").
- Ensure that all repairs are performed only by authorised and specialised personnel.

**WARNING**

- Prior to any start-up, check the centrifuge, rotor, and accessories for signs of damage that can be discerned from the outside. Special attention must be paid to all of the rubber parts (e.g. motor cover, lid seal, and adapters) in terms of visible structural changes. Defective parts must be replaced immediately.
- Open the centrifuge when it is not in use so that moisture can evaporate.

3.6.3 Fire prevention

**DANGER**

- Do not spin explosive or inflammable substances.
- Do not use the centrifuge within hazardous locations.

3.6.4 Chemical and biological safety

If pathogenic, toxic, or radioactive samples are intended to be used in the centrifuge, it is in the responsibility of the user to ensure that all necessary safety regulations, guidelines, precautions, and practices are adhered to accordingly.

**DANGER**

- Infectious, toxic, pathogenic, and radioactive substances may only be used in special, certified containment systems with a bio-seal in order to prevent the material from being released.
- Take suitable precautions for your own safety if there is a risk of toxic, radioactive, or pathogenic contamination
- Materials that chemically react with each other with a high level of energy are prohibited.

**WARNING**

- Keep informed about local measures to avoid harmful emissions (depending on the substances to be centrifuged).
- Protective clothing is not required for the operation of the centrifuge. The materials to be centrifuged may, however, require special safety measures (e.g. centrifugation of infectious, toxic, radioactive, or pathogenic substances).

3 Safety

3.6.5 Safety instructions for centrifugation

For safe operation, observe the following before starting the centrifuge:



WARNING

- Ensure that the centrifuge was set up properly (see chapter 5 - "Set-up and connection").
- Maintain a safety distance of at least 30 cm (12 inches) around the centrifuge.
- Do not store any dangerous goods in the centrifuge area.
- Do not stay in the safety area longer than what is absolutely necessary for the operation of the centrifuge.
- Only use the centrifuge with rotors and accessories that have been approved by the manufacturer. We explicitly warn against the use of equipment of poor quality. Breaking glass or bursting vessels can cause dangerous imbalances at high speeds
- Ensure that rotor and buckets are correctly fitted (see chapter 6.2.2.1 - "Installation of the rotor").
- Observe the instructions on the installation of accessories (see chapter 6.2.2.2 - "Installation of accessories").
- The rotor must be loaded symmetrically at equal weights.
- If liquids with a density $> 1.2 \text{ g/cm}^3$ are used, reduce the speed (see chapter 2.2.2.2 - "Density").
- Do not use the centrifuge if the rotor is loaded asymmetrically.
- Do not use the centrifuge with tubes that are excessively long.



WARNING

3.6.6 Resistance of plastics

Chemical influences have a strong effect on the polymeric chains of plastics, and, therefore, on their physical properties. Plastic parts can be damaged if solvents, acids, or alkaline solutions are used.



NOTE

- Refer to the resistance data (see chapter 11.4 - "Resistance data")!

3.6.7 Service life of rotors and accessories

The rotors and accessories have a limited service life.



- Perform regular checks (at least once per month) for safety reasons!
- Pay special attention to changes, such as corrosion, cracks, material abrasion, etc.
- After 10 years, they must be inspected by the manufacturer.
- After 50,000 cycles, the rotor must be scrapped for reasons of safety.
- If other data concerning the service life are engraved on the rotor or bucket, these data shall apply accordingly. For example, a bucket with the engraving "max. cycles = 10,000" has a service life of 10,000 cycles, and a rotor with the engraving "Exp. date 02/20" must be scrapped in February 2020 at the latest (see figure).



Fig. 4: Different service life – engraving on the bucket/rotor



- Refer to the table of rotors and accessories with a different service life (see chapter 11.3 - "Table of the service life of rotors and accessories")!

3.7 Safety devices

3.7.1 Lid lock device

The centrifuge can only be started when the lid is properly closed. The electrical lock must be locked. The lid can only be opened when the rotor has stopped. If the lid is opened by way of the emergency release system during operation, the centrifuge will immediately switch off and decelerate brakeless. If the lid is open, the drive is completely separated from the mains power supply, i.e. the centrifuge cannot be started (see chapter 7.1.1 - "Emergency lid release").

3.7.2 Standstill monitoring system

Opening of the centrifuge lid is only possible if the rotor is at a standstill. This standstill is checked by the microprocessor.

3 Safety

3.7.3 System check

An internal system check monitors the data transfer and sensor signals with regard to plausibility. Malfunctions are indicated by error messages with a number in the speed/rcf display (see chapter 7.2 - "Table of error codes").

3.7.4 Earth conductor check

An earth conductor check can be carried out by authorized and specialized personnel using a suitable measuring instrument. Please contact the Sigma service department (see chapter 7.3 - "Service contact").

3.8 Measures in the event of hazards and accidents



DANGER

- If an emergency arises, switch off the centrifuge immediately!
- If in doubt, call the emergency doctor!

3.9 Remaining hazards

The unit was built state-of-the-art and according to the accepted safety rules. However, danger to life and limb of the operator, or of third parties, or impairments of the unit or other material assets cannot be completely excluded when the unit is being used.

- Use the unit only for the purpose that it was originally intended for (see chapter 1.2 - "Intended use").
- Use the unit only if it is in a perfect running state.
- Immediately eliminate any problems that can affect safety.

4 Storage and transport

4.1 Dimensions and weight

	Sigma 2-7, Sigma 2-7 IVD
Height:	293 mm
Height with open lid:	643 mm
Width:	378 mm
Depth:	535 mm
Weight:	23 kg

4.2 Storage conditions

The centrifuge can be stored in its original packaging for up to a year.

- Store the centrifuge only in dry rooms.
- The storage temperature must be above -20°C .
- If you would like to store it for more than one year, or if you intend to ship it overseas, please contact the manufacturer.

4.3 Notes on transport

- When lifting the centrifuge, always reach under the centrifuge from the side.



CAUTION

The centrifuge weighs approx. 23 kg!

- For transport use suitable packaging and, if at all possible, the original packaging (see chapter 4.4 - "Packaging").

4 Storage and transport

4.4 Packaging

The centrifuge is packaged in a cardboard box.

- Open the box.
- Take out the box containing the accessories.
- Remove the upper foam element.
- Lift the centrifuge with both foam cushions out of the cardboard box.
When lifting the centrifuge, always reach under the centrifuge from the side.



CAUTION

The centrifuge weighs approx. 23 kg!

- Retain the packaging for any possible future transport of the centrifuge.

4.5 Transport safety device

The centrifuge is not equipped with a transport safety device.

5 Set-up and connection

5.1 Installation site

Operate the centrifuge only in closed and dry rooms.

All the energy supplied to the centrifuge is converted into heat and emitted to the ambient air.

- Ensure sufficient ventilation.
- Keep a safety distance of at least 30 cm around the centrifuge so that the vents in the centrifuge remain fully effective.
- Do not subject the centrifuge to thermal stress, e.g. by positioning it near heat generators.
- Avoid direct sunlight (UV radiation).
- The table must be stable and have a solid, even surface.
- Attention: During transport from cold to warmer places, condensational water will collect inside the centrifuge. It is important to allow sufficient time for drying (min. 24 h) before the centrifuge can be used again.

5.1.1 Type of connection



DANGER

The operating voltage on the name plate must correspond to the local supply voltage!

Sigma centrifuges are units of protection class I. The centrifuges of this model series have a three-wire power cord with an IEC C13 connector.

5.1.2 Customer-provided fuses

Typically, the centrifuge must be protected with 16 Amp L or B fuses that are to be provided by the customer.

6 Using the centrifuge

6 Using the centrifuge

6.1 Initial start-up



DANGER

- Before the initial start-up, please ensure that your centrifuge is properly set up and installed (see chapter 5 - "Set-up and connection").

6.2 Switching the centrifuge on

- Press the mains power switch.
The display then illuminates. The centrifuge is ready for operation.

6.2.1 Opening and closing the lid

The lid can be opened if the centrifuge is at a standstill.

- Press the lid key in order to open the lid.

The centrifuge cannot be started if the lid is opened.

- To close, press with both hands slightly on the lid until the lid lock is locked.



WARNING

Do not place your fingers between the lid and the housing when closing the lid. Risk of crushing!

6.2.2 Installation of rotors and accessories

6.2.2.1 Installation of the rotor

- 1 Rotor tie down screw
- 2 Motor shaft
- 3 Angle rotor

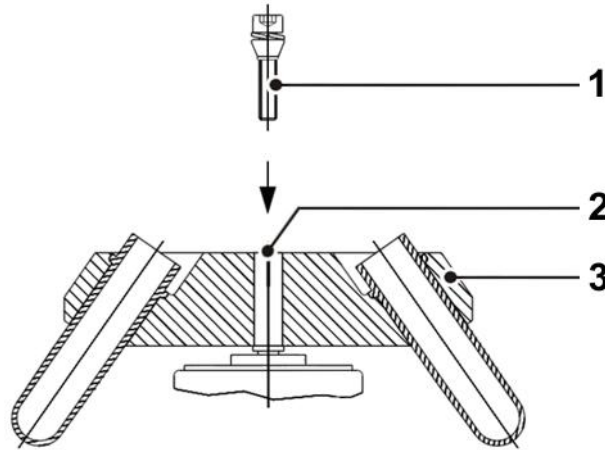

Fig. 5: Installation of an angle rotor

- Open the centrifuge lid by pressing the lid key.
- Loosen the rotor tie-down screw by turning it anti-clockwise, but do not remove it.
- Lower the rotor with its central bore straight down onto the motor shaft.
- Hand-tighten the rotor fastening nut clockwise (corresponds to 1 Nm).



WARNING

Once a day or after 20 cycles, the rotor tie-down screw must be loosened by some turns, and the rotor must be lifted and fastened again. This ensures a proper connection between the rotor and the motor shaft.



NOTE

Rotors can be used without a cover. This leads, however, to higher levels of noise and temperatures when running.

- Follow the safety instructions and hazard warnings (see chapter 3 - "Safety")!

6 Using the centrifuge

6.2.2.2 Installation of accessories

- Only use inserts that are suitable for the rotor (see chapter 11.1 - "Range of accessories").
- All buckets of the swing-out rotor need to be installed when spinning.
- Always load the opposite inserts/buckets of the rotors with the same accessories and fill to avoid imbalance.

Centrifugation with different tube sizes

Working with different tube sizes is possible. In this case, however, it is very important that opposite inserts are identical (see figure).

correct

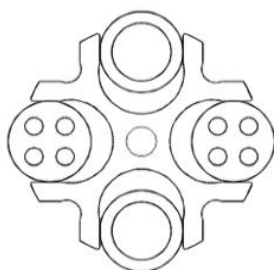

incorrect

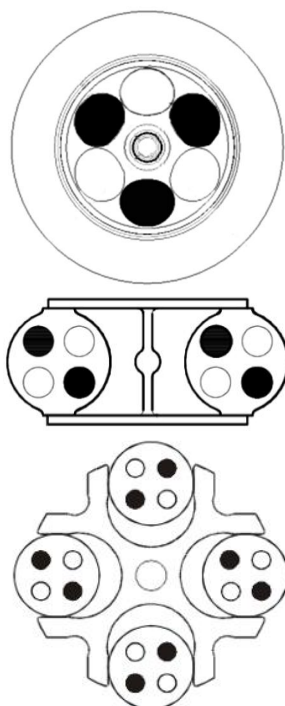

Fig. 6: Permissible and impermissible loading of a swing-out rotor with different tube sizes (example illustration)

Centrifugation with low capacity

- Install the tubes symmetrically so that the buckets and their inserts are loaded evenly.
- It is not permissible to load angle rotors on only one axis.

correct



incorrect

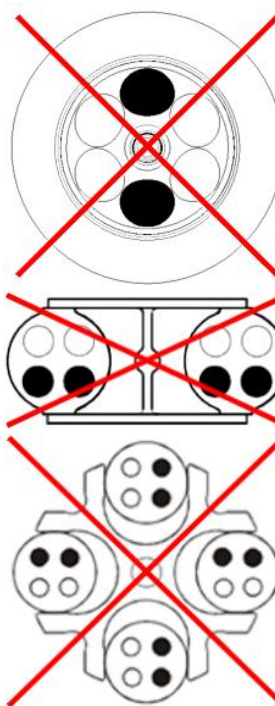

Fig. 7: Permissible and impermissible loading of an angle rotor and a swing-out rotor (example illustrations)

6.2.2.3 Adapters

In order to ensure easy handling, even if vessels of various sizes are used, carrier systems were developed.

- Load the opposite adapters with the same number of vessels and with the same weights in order to avoid imbalance.
- If all of the compartments of a carrier are not used, the buckets must be loaded evenly. Loading the edges of a bucket only is not permissible.

6.2.2.4 Tubes

- Load the tubes outside of the centrifuge. Liquids in the bores of the rotor cause corrosion.
- Fill the tubes carefully and arrange them according to their weight. Imbalances result in the excessive wear of the bearings.
- Follow the safety instructions and hazard warnings (see chapter 3 - "Safety")!

6 Using the centrifuge

6.3 Control System "Spincontrol Basic"

6.3.1 User interface

- 1 Display
- 2 Set key
- 3 Program key
- 4 Arrow keys
- 5 Lid key
- 6 Start/Stop key
- 7 Quick run key



Fig. 8: User interface

The centrifuge is started directly via the user interface. When the centrifuge is switched on, all segments will be illuminated for a short time. It is now ready for operation.

6.3.2 Display

The centrifuge display has the following display fields:

- 1 Field for deceleration curves, run mode, and programs
- 2 Speed / RCF field
- 3 Time field
- 4 Field for rotor selection

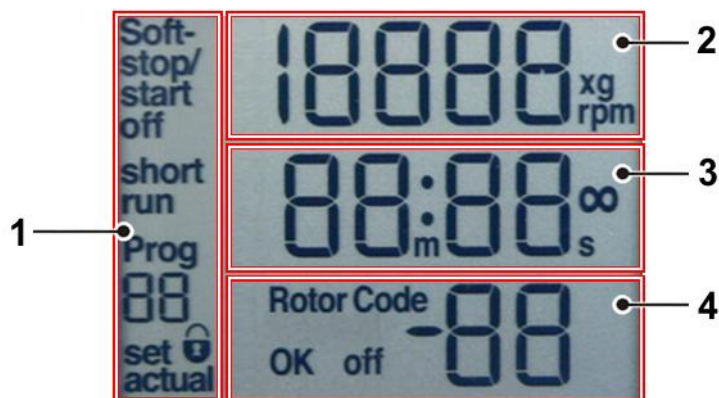

Fig. 9: Display, completely illuminated

6.3.3 Starting a centrifugation run

The centrifuge is ready for operation when the mains power switch is on and the lid is closed.

- Press the start/stop key in order to start a centrifugation run.

During the centrifuge run, a blue LED in the base area of the centrifuge lights up. It goes out when the centrifuge is at a standstill.

6.3.4 Interrupting a centrifugation run

- Press the start/stop key in order to interrupt a centrifugation run. The centrifugation run will be terminated prematurely.

6.3.5 Interrupting a deceleration process

- Press the start/stop key during a deceleration process in order to interrupt it and to restart the centrifuge.

6.3.6 Speed / Relative centrifugal force (RCF)

The RCF value is determined by the rotor geometry and speed. The RCF and speed values, therefore, depend on each other. If one of the two values is entered, the other value will be set automatically.

- To preselect a speed value or a RCF value, press the set key repeatedly until the corresponding unit flashes on the display.
- Select the desired speed or RCF value via the arrow keys.
- Confirm the selection by pressing the start/stop key.

The data will also be accepted and saved after approx. 20 seconds if no other key is pressed within this time period.

During operation, you can switch from the speed value to the RCF value and vice versa via the arrow keys.

6.3.6.1 Changing the speed/RCF value during centrifugation

The preselected speed or RCF value can be changed during centrifugation.

- Press the set key repeatedly until the desired unit flashes on the display.
- Change the speed or RCF value by pressing the arrow keys. The parameters will take effect immediately.

6 Using the centrifuge

6.3.7 Runtime

The preselected total runtime is displayed in the lower line of the display. During centrifugation, the remaining runtime is displayed. The runtime of the centrifuge can be set at one-second-intervals up to 99 minutes and 59 seconds.

- To select a runtime, press the set key repeatedly until the time unit flashes on the display.
- Select the desired runtime by pressing the arrow keys.
- Confirm the selection by pressing the start/stop key.

The data will also be accepted and saved after approx. 20 seconds if no other key is pressed within this time period.

6.3.7.1 Changing the runtime during centrifugation

The preselected runtime can be changed during centrifugation.

- Press the "set" key repeatedly until the time unit flashes on the display.
- Change the desired runtime by pressing the arrow keys. The parameters will be accepted immediately.



NOTE

If the centrifugation time is changed during the run, the centrifuge will run for the entire new time and will disregard the previous runtime that has already elapsed.

6.3.7.2 Short run

During the short run, the centrifuge accelerates at maximum power until the maximum speed is reached.

- Keep the quick run key pressed during the short run.

The message "short run" and the duration of the short run is displayed.

When the quick run key is released, the centrifuge decelerates at maximum power to a standstill.

After the short run, the lid unlocks automatically and the program that was set beforehand is displayed again.

6.3.7.3 Continuous run

During the continuous run, the runtime of the centrifuge is unlimited and must be stopped manually. The centrifuge accelerates during the continuous run until the set speed is reached.

- To start the continuous run, press the set key until the time unit flashes on the display.
- Press the down-key (arrow key) until the display switches from "00:10" to "--:--".

After 99 min 59 sec, any additional runtime will no longer be displayed, but the centrifugation will continue.

- To stop a continuous run, press the start/stop key. The centrifugation will end.
- Enter a runtime. The centrifugation will end after this time.

6.3.8 Rotor selection

In the factory setting, the rotor 11071 and the bucket 13299 are preselected. If another rotor is used, the configuration must be adapted accordingly so that the prescribed maximum speed can be reached and the correct RCF value can be indicated.

- To select a rotor, press and hold the Set button.
- Press the upper arrow button 3 times and then release the Set button.
- Use the arrow buttons to select the ID number (code) of the rotor that is used from the following list:

Code	Rotor / bucket
1	11037
2	11071 with 13299
3	11071 with 13296
4	12072
5	12073

- Press the set key to confirm the input.

The RCF value will be adjusted automatically to the selected rotor.



The rotor selection will be saved under the corresponding program number.

6 Using the centrifuge

6.3.9 Softstart and softstop function

The softstart function is used to extend the acceleration time, whereas the softstop function is used to extend the deceleration time. The current combination is shown on the display.

- To activate the softstart and softstop functions, press the set key repeatedly until "Soft-stop/start" flashes in the upper left part of the display.
- Press the arrow keys until "Soft-stop/start on" is displayed. The softstart and softstop functions are now activated.
- Press the set key until "Soft stop on" is displayed. Only the softstop function will be active and the centrifuge will start at normal speed.
- Press the set key until "Soft off" is displayed. The softstart and softstop functions are now deactivated.

The data will be accepted immediately and saved after approx. 20 seconds. You can also change the settings as described above during a centrifugation run.

6.3.10 Automatic lid opening function

The automatic lid opening function ensures that the lid opens when the rotor has stopped. In the factory settings, the automatic lid opening function is activated.

- To deactivate the automatic lid opening function, press and hold the Set button.
- Press the upper arrow button 5 times and then release the Set button.

The automatic lid opening function is deactivated.

- Proceed in the same manner in order to activate the automatic lid opening function.

6.3.11 Start delay ("Clotting time")

This function has been specially developed for laboratories that use serum tubes with a so-called clot activator. For this application, the samples must be at rest for a defined time prior to the actual centrifugation. This time is referred to as the "clotting time".

The start delay function can be used to start the entire centrifugation process, including the clotting time, following the insertion of the samples without any further inputs.

After the programmed delay has elapsed, the centrifuge will start automatically with the preset parameters.

In the factory settings, this function is deactivated.

- To deactivate the function, press and hold the Set button.
- Press the upper arrow button 4 times and then release the Set button.
- Select the desired delay by way of the arrow buttons.
- Press the Set button in order to confirm the selection.

The selected delay is activated. During the set start delay, the word "clot" is displayed and the blue LED flashes slowly. When the actual centrifugation process starts, the LED lights continuously.

- To deactivate the delay function, proceed as described above and select the value 0.

6.3.12 Sound signal

This function provides a sound signal that is issued at the end of a centrifugation run, in the event of an imbalance, or when an error message is displayed. In the factory settings, the sound signal is activated.

- To deactivate the sound signal, press and hold the Set button.
- Press the upper arrow button 2 times and then release the Set button.

The sound signal is deactivated.

- Proceed in the same manner in order to activate the sound signal.

6.3.13 Button signal

This function provides a sound signal that is issued whenever a button is pressed. In the factory settings, the button signal is activated.

- To deactivate the button signal, press and hold the Set button.
- Press the upper arrow button 6 times and then release the Set button.

The button signal is deactivated.

- Proceed in the same manner in order to activate the button signal.

6.3.14 Button lock

In order to prevent any unauthorised use of the centrifuge, its buttons can be locked. In the factory settings, the button lock is deactivated.

- To active the button lock, press the Start/Stop button 3 times while the lid is open.

The button lock is activated. The Start/Stop button, lid button, and arrow buttons for selecting the indication of the speed or RCF value remain active even if the button lock is active.

- Proceed in the same manner in order to deactivate the button lock.

6 Using the centrifuge

6.3.15 Programs

The program is used to save or load certain recurrent settings of the centrifuge. 10 different programs can be saved and called up.

6.3.15.1 Saving the current settings

- Press the program key. Then, select a program number by pressing the arrow keys. The display "Prog - - " will now flash.
- Select the correct rotor.
- Press the set key repeatedly until the corresponding unit flashes on the display. Select the desired parameters.
- In order to save the data, start the centrifuge or press the set key repeatedly until the indication "Prog - -" stops flashing.



NOTE

Program numbers that are already occupied will be overwritten with the current data.

6.3.15.2 Calling up stored programs

- Press the program key. Then, select a program number by pressing the arrow keys. The display "Prog - - " will now flash.
- Ensure that the correct rotor is selected.
- In order to save the data, start the centrifuge or press the set key repeatedly until the indication "Prog - -" stops flashing.

6.4 Switching the centrifuge off

- Open the centrifuge when it is not in use so moisture can evaporate.
- Switch the centrifuge off by pressing the mains power switch.

7 Malfunctions and error correction

7.1 General malfunctions

Malfunctions are indicated by error messages with a number in the speed/RCF display. In addition, the blue LED flashes rapidly.

In the event of a fatal error (e.g. a defective lid lock), a certain safety time will be counted down on the display. During this time, "ERR" and "SAFE" flash alternately on the display. When the time is up, "OFF" will be displayed.



WARNING

Do not switch the centrifuge off until "OFF" is displayed! This is necessary in order to ensure that the rotor is at a complete standstill.

- Eliminate the source of the problem (see tables below).
- Acknowledge the error messages with the lid key.

Type of error	Possible reason	Correction
No indication on the display	No power in the mains supply	Check fuse in the mains supply
	Power cord is not plugged in	Plug in power cord correctly
	Mains power switch off	Switch mains power switch on
	Lid is not closed correctly	Close the lid
Centrifuge cannot be started: The set speed value is displayed in an unchanged manner	Several	Power off/on. If the error occurs again, contact service
	The lid lock is not closed correctly	Open and close lid. If the error occurs again, contact service
Centrifuge decelerates during operation and displays an error from 1 to 18 after powering on	Several	Power off/on. If the error occurs again, contact service
Centrifuge decelerates during operation and displays error 19 after powering on	Several	Quit by pressing the lid key
Temperature value cannot be reached (only for refrigerated centrifuges)	Condenser dirty	Contact service

7 Malfunctions and error correction

7.1.1 Emergency lid release

In the event of a power failure, it is possible to manually open the centrifuge lid.

- Switch off the mains power switch and disconnect the power cord from the socket.
- Remove the plug (see figure, item 1) from the opening on the left side of the control panel, e.g. with a screwdriver.



Fig. 10: Position of the opening for the emergency lid release

- Insert the supplied hexagon socket key horizontally into the hole and turn it anti-clockwise to the stop. The lid lock will then audibly unlock.



Fig. 11: Manual release of the lid lock

- Then, reinsert the plug.



WARNING

Do not unlock or open the lid unless the rotor is at a standstill.

If the lid is opened via the emergency lid release system during a centrifuge run, the centrifuge will be switched off immediately and decelerate in an unbraked manner.

7 Malfunctions and error correction

7.2 Table of error codes

Error no.	Kind of error	Measures	Note
1-9	System error	<ul style="list-style-type: none"> Allow to slow down Power off/on 	All these errors stop the centrifuge or cause it to decelerate brakeless
10-19	Speedometer error	<ul style="list-style-type: none"> Allow to slow down Power off/on 	
20-29	Motor error	<ul style="list-style-type: none"> Power off Ensure ventilation 	
30-39	EEPROM error	<ul style="list-style-type: none"> Allow to slow down Power off/on 	With error 34, 35, and 36, the centrifuge will stop; with error 37 and 38 only an error message will be given
40-45	Temperature error (only for refrigerated centrifuges)	<ul style="list-style-type: none"> Allow to slow down Power off Allow to cool down Provide better ventilation (only air cooled centrifuges) Provide sufficient water throughput (only water cooled centrifuges) 	
46-49	Imbalance error	<ul style="list-style-type: none"> Allow to slow down Power off Eliminate the imbalance 	
50-59	Lid error	<ul style="list-style-type: none"> Press lid key Close lid Remove foreign matter from the opening of the lid lock device 	With error 50 and 51, the centrifuge will stop
60-69	Process error	<ul style="list-style-type: none"> Allow to slow down Power off/on 	With error 60 message "power failure during run", with error 61, the message "stop after power on"
70-79	Communication error	<ul style="list-style-type: none"> Allow to slow down Power off/on 	
80-89	Parameter error	<ul style="list-style-type: none"> Power off Allow to cool down Provide for better ventilation 	With error 83, error message only
90-99	Other errors	<ul style="list-style-type: none"> Check connections Provide sufficient water throughput (only water cooled centrifuges) 	



NOTE

If it is impossible to eliminate the errors, contact the service!

7 Malfunctions and error correction

7.3 Service contact

In the event of queries, malfunctions, or spare part enquiries:

From Germany:

Contact

Sigma Laborzentrifugen GmbH
An der Unteren Söse 50
37520 Osterode (Germany)
Tel. +49 (0) 55 22 / 50 07-44 44
E-mail: support.lab@sigma-zentrifugen.de

Outside Germany:

Contact our agency in your country. All agencies are listed at
www.sigma-zentrifugen.de → [Sales Partners]



NOTE

- If you would like to utilise our service, please state the type of your centrifuge and its serial number.

8 Maintenance and service

The centrifuge, rotor, and accessories are subject to high mechanical stress. Thorough maintenance performed by the user extends the service life and prevents premature failure.



CAUTION

If corrosion or other damage occurs due to improper care, the manufacturer cannot be held liable or subject to any warranty claims.

- Use soap water or other water-soluble, mild cleaning agents with a pH value between 6 and 8 for cleaning the centrifuge and accessories.
- Avoid corrosive and aggressive substances.
- Do not use solvents.
- Do not use agents with abrasive particles.
- Do not expose the centrifuge and rotors to intensive UV radiation or thermal stress (e.g. by heat generators).

8.1 Maintenance

8.1.1 Centrifuge

- Unplug the mains power plug before cleaning.
- Carefully remove all liquids, including water and particularly all the solvents, acids, and alkaline solutions from the rotor chamber using a cloth in order to avoid damage to the motor bearings.
- If the centrifuge has been contaminated with toxic, radioactive, or pathogenic substances, clean the rotor chamber immediately with a suitable decontamination agent (depending on the type of contamination).



WARNING

Take suitable precautions for your own safety if there is a risk of toxic, radioactive, or pathogenic contamination.

- Grease the motor shaft slightly after cleaning (grease for load-bearing bolts part no. 70284).

8 Maintenance and service

8.1.2 Accessories



CAUTION

For the care of the accessories, special safety measures must be considered as these are measures that will ensure operational safety at the same time!

- Immediately rinse off the rotor, buckets, or accessories under running water if they have come into contact with any liquids that may cause corrosion. Use a brush for test tubes in order to clean the bores of angle rotors. Turn the rotor upside down and allow it to dry completely.
- Clean the accessories outside the centrifuge once a week or preferably after each use. Adapters should be removed, cleaned and dried.



CAUTION

Do not clean the accessories in a dishwasher!

Cleaning in a dishwasher removes the anodised coating; the result is cracking in areas that are subject to stress.

- If the rotors or accessories have been contaminated with toxic, radioactive, or pathogenic substances, clean them immediately with a suitable decontamination agent (depending on the type of contamination). Take suitable precautions for your own safety if there is a risk of toxic, radioactive, or pathogenic contamination.
- Dry the accessories with a soft cloth or in a drying chamber at approx. 50°C.

8.1.2.1 Plastic accessories

The chemical resistance of plastic decreases with rising temperatures (see chapter 11.4 - "Resistance data").

- If solvents, acids, or alkaline solutions have been used, clean the plastic accessories thoroughly.



WARNING

Plastic accessories must not be greased!

8.1.3 Rotors, buckets and carriers

Rotors, buckets and carriers are produced with the highest precision, in order to withstand the permanent high stress from high gravitational fields. Chemical reactions as well as stress-corrosion (combination of oscillating pressure and chemical reaction) can affect or destroy the metals. Barely detectable cracks on the surface can expand and weaken the material without any visible signs.

- Check the material regularly (at least once a month) for
 - cracks
 - visible damage of the surface
 - pressure marks
 - signs of corrosion
 - other changes.
- Check the bores of the rotors and multiple carriers.
- Replace any damaged components immediately for your own safety.
- Grease the rotor tie-down screw after cleaning with grease for load bearing bolts (part no. 70284) and spread the grease with a cloth.

8.1.4 Glass breakage



CAUTION

In the case of glass breakage, immediately remove all glass particles (e.g. with a vacuum cleaner). Replace the rubber cushions since even thorough cleaning will not remove all glass particles.

Glass particles will damage the surface coating (e.g. anodising) of the buckets, which will then lead to corrosion.

Glass particles in the rubber cushions of the buckets will cause glass breakage again.

Glass particles on the pivot bearing of the load-bearing bolts prevent the buckets and carriers from swinging evenly, which will cause an imbalance.

Glass particles in the rotor chamber will cause metal abrasion due to the strong air circulation. This metal dust will not only pollute the rotor chamber, rotor, and materials to be centrifuged but also damage the surfaces of the accessories, rotors, and rotor chamber.

In order to completely remove the glass particles and metal dust from the rotor chamber:

- Grease the upper third of the rotor chamber with e.g. Vaseline.
- Then, let the rotor rotate for a few minutes at a moderate speed (approx. 2000 rpm). The glass and metal particles will now collect at the greased part.
- Remove the grease with the glass and metal particles with a cloth.
- If necessary, repeat this procedure.

8 Maintenance and service

8.2 Sterilisation and disinfection of the rotor chamber and accessories

- Use commercially-available disinfectants such as, for example, Sagrotan[®], Buraton[®], or Terralin[®] (available at chemist's shops or drugstores).
- The centrifuge and the accessories consist of various materials. A possible incompatibility must be considered.
- Before using cleaning or decontamination agents that were not recommended by us, contact the manufacturer to ensure that such a procedure will not damage the centrifuge.
- For autoclaving, consider the continuous heat resistance of the individual materials (see chapter 8.2.1 - "Autoclaving").

Please contact us if you have any queries (see chapter 7.3 - "Service contact").



DANGER

If dangerous materials (e.g. infectious and pathogenic substances) are used, the centrifuge and accessories must be disinfected.

8.2.1 Autoclaving

The service life of the accessories essentially depends on the frequency of autoclaving and use.

- Replace the accessories immediately when the parts show changes in colour or structure or in the occurrence of leaks etc.
- During autoclaving, the caps of the tubes must not be screwed on in order to avoid the deformation of the tubes.



NOTE

It cannot be excluded that plastic parts, e.g. lids or carriers, may deform during autoclaving.

Accessories	Max. temp. (°C)	Min. time (min)	Max. time (min)	Max. cycles
Aluminium buckets	134-138	3	5	-
Aluminium rotors	134-138	3	5	-
Glass tubes	134-138	3	40	-
Polyallomer / polycarbonate rectangular carriers	115-118	30	40	-
Polyallomer / polycarbonate round carriers	115-118	30	40	-
Polyamide buckets	115-118	30	40	10
Polycarbonate / polyallomer lids for angle rotors	115-118	30	40	20
Polycarbonate tubes	115-118	30	40	20
Polyphenylsulfone (PPSU) caps for buckets	134-138	3	5	100
Polypropylene balance adapter for blood-bag systems	115-118	30	40	n.s.
Polypropylene copolymer tubes	115-121	30	40	20
Polypropylene rectangular carriers	115-118	30	40	-
Polypropylene rotors	115-118	30	40	20
Polypropylene round carriers	115-118	30	40	-
Polysulfone caps for buckets	134-138	3	5	100
Polysulfone lids for angle rotors	134-138	3	5	100
Rubber adapters	115-118	30	40	-
Stainless-steel balance weight for blood-bag systems	121	30	30	n.s.
Teflon tubes	134-138	3	5	100

8 Maintenance and service

8.3 Service



DANGER

In the event of service work that requires the removal of the panels, there is a risk of electric shock or mechanical injury. Only qualified specialist personnel is authorised to perform this service work.

The centrifuge is subject to high mechanical stress. In order to be able to withstand this high level of stress, high-quality components were used during the production of the centrifuge. Nevertheless, wear cannot be excluded and it may not be visible from the outside. Especially the rubber parts that are – among other things – part of the motor suspension, are subject to ageing.

This is why we recommend having the centrifuge checked by the manufacturer during an inspection once per year in the operating state and once every three years in the dismantled state. Rubber parts should be replaced after three years.

Information and appointments:

In Germany:

Contact

Sigma Laborzentrifugen GmbH

An der Unteren Söse 50

37520 Osterode (Germany)

Tel. +49 (0) 55 22 / 50 07-44 44

E-mail: support.lab@sigma-zentrifugen.de

Outside Germany:

Contact our agency in your country. All agencies are listed at www.sigma-zentrifugen.de → [Sales Partners]



NOTE

- If you would like to utilise our service, please state the type of your centrifuge and its serial number.

8.4 Return of defective parts

Although we exercise great care during the production of our products, it may be necessary to return a unit or accessory to the manufacturer. In order to ensure the quick and economical processing of returns of centrifuges, spare parts, or accessories, we require complete and extensive information concerning the process. Please fill in the following forms completely, sign them, enclose them with the return package, and send them together with the product to:

Sigma Laborzentrifugen GmbH
An der Unteren Söse 50
37520 Osterode (Germany)

1. Declaration of decontamination

As a certified company and due to the legal regulations for the protection of our employees and of the environment, we are obliged to certify the harmlessness of all incoming goods. For this purpose, we require a declaration of decontamination.

- The form must be filled in completely and signed by authorised and specialised personnel only.
- Affix the original form in a clearly visible manner to the outside of the packaging.



We will return the unit if no declaration of decontamination is provided!

2. Form for the return of defective parts

This form is for the product-related data. They facilitate the assignment, and they enable the quick processing of the return. If several parts are returned together in one packaging, please enclose a separate problem description for every defective part.

- A detailed problem description is necessary in order to perform the repair quickly and economically.



If the form does not include a description of the malfunction, neither a refund nor a credit note can be issued. In this case, we reserve the right to return the parts to you at your expense.

- Upon request, we will prepare and submit to you a cost estimate prior to performing the repair. Please confirm such cost estimate within 14 days. If the cost estimate has still not been confirmed after 4 weeks, we will return the unit. Please note that you must bear the incurred costs.

8 Maintenance and service



The unit must be packaged in a transport-safe manner. Please use the original packaging, if at all possible.
If the product is dispatched to us in unsuitable packaging, you will be charged the cost for returning it to you in new packaging.

The forms can be downloaded online from
www.sigma-zentrifugen.de → [Service] → [Overhaul and repair].

9 Disposal

9.1 Disposal of the centrifuge



In accordance with the directive 2002/96/EC, SIGMA centrifuges are marked with the symbol shown to the left. This symbol means that it is not permissible to dispose of the unit among household waste.

- You can return these centrifuges free of cost to Sigma Laborzentrifugen GmbH.
- Ensure that the unit is decontaminated. Fill in a declaration of decontamination (see chapter 8.4 - "Return of defective parts").
- Comply with any other applicable local rules and regulations.

9.2 Disposal of the packaging

- Use the packaging to return the centrifuge for disposal or
- dispose of the packaging, after having separated the individual materials.
- Comply with all local rules and regulations.

10 Technical data

10 Technical data

Manufacturer:	Sigma Laborzentrifugen GmbH An der Unteren Söse 50 37520 Osterode Sigma Germany	
Type:	Sigma 2-7	Sigma 2-7 IVD
Order no.:	10226	10227
<u>Connection requirements</u>		
Electrical connection:	see name plate	
Protection class:	I	
IP code:	20	
Max. connected load (kVA):	0.26 (at 100-240 V / 50-60 Hz)	
Max. power consumption (kW):	0.23 (at 100-240 V / 50-60Hz)	
Max. current consumption (A):	2.6 (at 220-240 V / 50-60Hz)	
Input fuse (AT):	6.3 (at 220-240 V / 50-60Hz)	
<u>Performance data</u>		
Max. speed (rpm):	4,000	
Max. capacity (ml):	450 (30 x 15 ml)	
Max. gravitational field (x g):	2,540	
Max. kinetic energy (Nm):	1,821	
<u>Other parameters</u>		
Time range:	10 sec – 99 min 59 sec, short run, continuous run	
<u>Physical data</u>		
Height (mm):	293	
Height with opened lid (mm):	643	
Width (mm):	378	
Depth (mm):	525	
Weight (kg):	23	
EMC as per EN 61326:	Class B (at 220-240 V / 50-60 Hz) Class A (at 120 V / 60 Hz) Class A (at 100 V / 50-60 Hz)	
Noise level (db(A)):	55 (at max. speed)	

10.1 Ambient conditions

- The figures are valid for an ambient temperature of $+23^{\circ}\text{C} \pm 2^{\circ}\text{C}$ and a nominal voltage $\pm 10\%$.



NOTE

At a nominal voltage of 100V or 200V, a tolerance of $+10\%$ / -5% applies.

- For indoor use only.
- Allowable ambient temperature $+5^{\circ}\text{C}$ to $+40^{\circ}\text{C}$.
- Max. relative humidity of air 80% up to 31°C with a linear decrease to 50% relative humidity of air at 40°C .
- Maximum altitude 2,000 m above sea level.

10.2 Technical documentation

For environmental reasons, the comprehensive technical documentation of the centrifuge (e.g. circuit diagrams) and the safety data sheets of the manufacturers of refrigerant and lubricants are not attached to this documentation.

You can order these documents from our service department.

11 Appendix

11 Appendix

11.1 Range of accessories

Part no.	Description	Max. speed (rpm)	Max. gravitational field (x g)
11037	Swing-out rotor, 2 place, for carrier no. 13035	4 000	
11071	Swing-out rotor, 4 place, for bucket no. 13296, 13299	4 000	
12072	Angle rotor 20 x 15 ml complete, incl. 10 sets buckets no. 13011, for tubes Ø 17 x up to 120 mm, e.g. no. 15015, 15020, 15023, 15024, Monovettes and culture tubes 15 ml no. 15115 Radius max. 13.9 cm, radius min. 8.0 cm, angle 33°	4 000	2 486
12073	Angle rotor 30 x 15 ml complete, incl. 15 sets buckets no. 13011, for tubes Ø 17 x up to 120 mm, e.g. no. 15015, 15020, 15023, 15024, Monovettes and culture tubes 15 ml no. 15115 Radius max. 13.9 cm, radius min. 5.8 cm, angle 33°	4 000	2 486
13035	Multiple carrier made of plastic for 4 tubes 5 - 15 ml, round bottom, max. Ø 17/19 x 80 - 105 mm, e.g. no. 15000, 15010, 15015, 15020, 15023, 15024, 15039, Monovettes 9 - 10 ml, Vacutainer, 1 set = 2 pcs Radius max. 13.3 cm, radius min. 4.9 cm	4 000	2 379
13296	Multiple carrier made of plastic for 6 tubes 5 - 15 ml, round bottom, max. Ø 17/19 x 80 - 105 mm, e.g. no. 15000, 15010, 15015, 15020, 15023, 15024, 15039, Monovettes 9 - 10 ml, Vacutainer, 1 set = 2 pcs. Radius max. 13.3 cm, radius min. 6.5 cm	4 000	2 379
13299	Round bucket, sealable with cap no. 17299, for round carriers no. 14299 - 14310, 1 set = 2 pcs., radius max. 14.2 cm, radius min. 3.8 cm	4 000	2 540

The complete list of accessories can be downloaded from www.sigma-zentrifugen.de.

11.1.1 Rotor radii

The information in the accessories table concerning the radius refers to the values of the respective rotor as shown below. The radius calculation is described in chapter 2.2.2.1 - "Speed, radius, and relative centrifugal force".

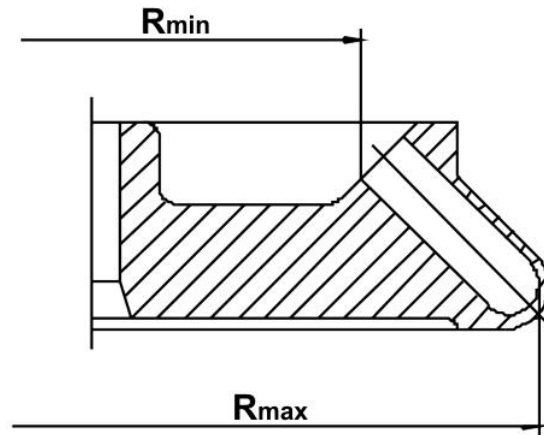

Fig. 12: Minimum and maximum radius of an angle rotor

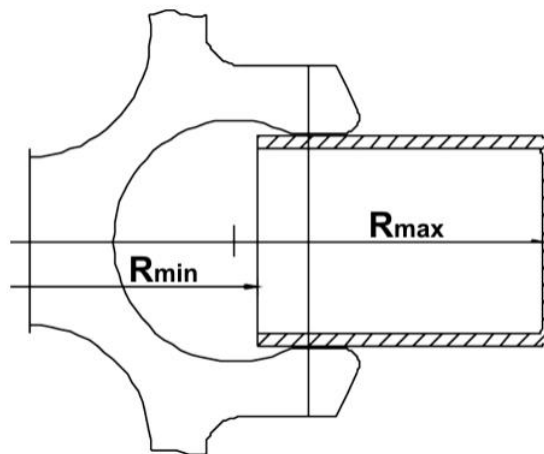

Fig. 13: Minimum and maximum radius of a swing-out rotor

11 Appendix

11.2 Speed-gravitational-field-diagram

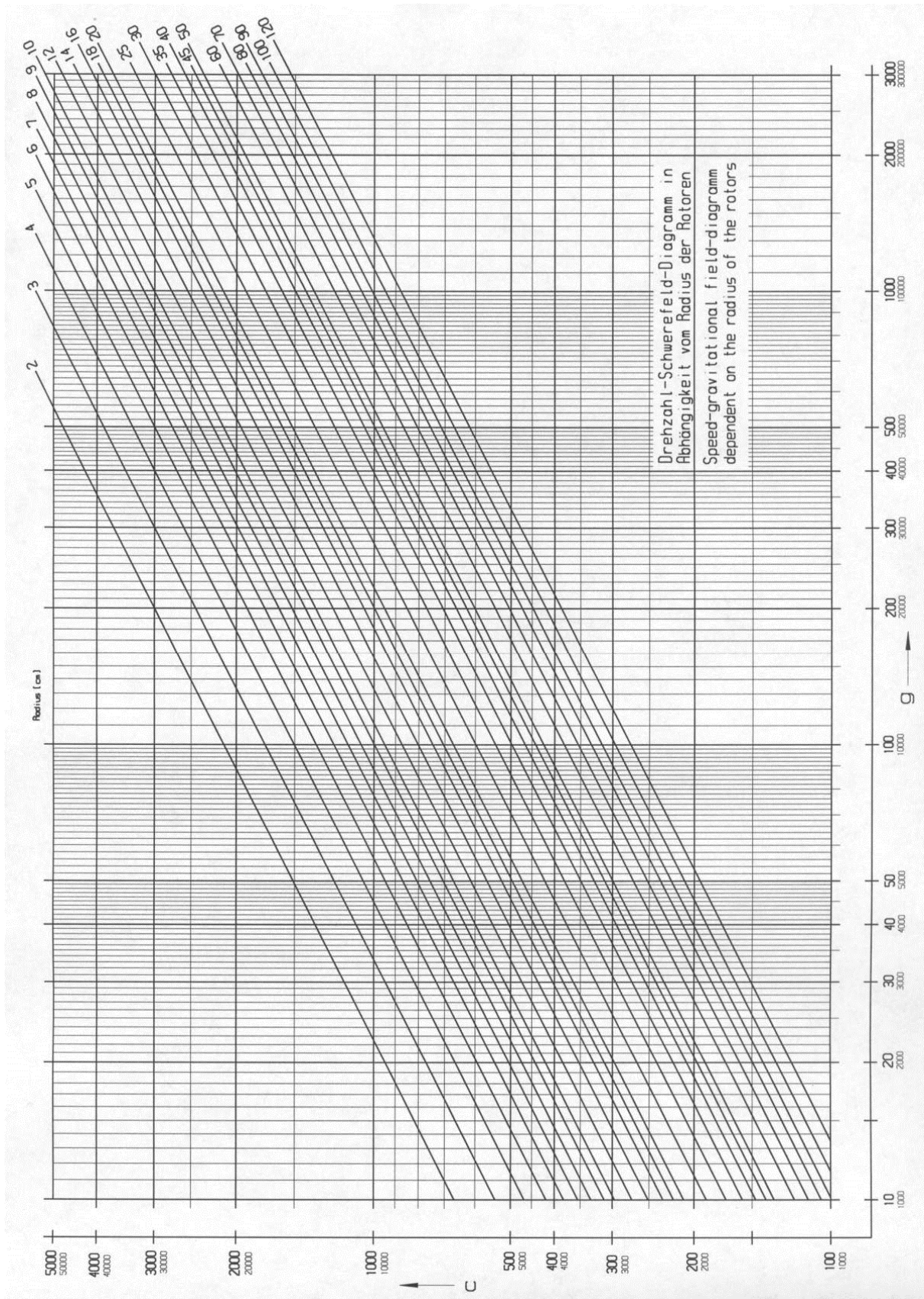



Fig. 14: Speed-gravitational-field-diagram

11.3 Table of the service life of rotors and accessories

Rotors and accessories with a different service life					
If no other data concerning the service life are engraved on the rotor or accessory, rotors and buckets must be checked by the manufacturer after 10,000 cycles. After 50,000 cycles, rotors must be scrapped for safety reasons.					
Rotor / bucket	Cycles	Service life ("Exp.Date")	Autoclaving	Suitable for centrifuge	Remarks
9100	15,000			4-15C, 4K15C, 4-16, 4-16S, 4-16K, 4-16KS, 6-15, 6K15, 6-16, 6-16K	without engraving, only "spincontrol professional" and "spincontrol S"
11026		7 years		1-14, 1-14K	
12033		5 years		1-16 Edition, 1-16K Edition	
12082		7 years		1-14, 1-14K	
12083		7 years		1-14, 1-14K	
12084		7 years		1-14, 1-14K	
12085		7 years		1-14, 1-14K	
12092		5 years	20x	1-14, 1-14K	
12093		5 years	20x	1-14, 1-14K	
12094		5 years	20x	1-14, 1-14K	
12096		5 years	20x	1-14, 1-14K	
12101		5 years	20x	1-15, 1-15K, 1-15P, 1-15PK	
12124		5 years	20x	1-15, 1-15K, 1-15P, 1-15PK	
12126		5 years	20x	1-15, 1-15K, 1-15P, 1-15PK	
12134		5 years	20x	1-16, 1-16K	
12135		5 years	20x	1-16, 1-16K	
12137		5 years	20x	1-16, 1-16K	
12500		7 years		6-15, 6K15, 6-16, 6-16K	
12600		7 years		6-16S, 6-16KS	
13218	20,000			4-16, 4-16S, 4-16K, 4-16KS, 6-16, 6-16S, 6-16K, 6-16KS	
13296		5 years	10x	2-6, 2-6E, 2-7	
13299		5 years	10x	2-6, 2-6E, 2-7, 2-16P, 2-16KL, 2-16KHL	
13635	25,000			6-16, 6-16K, 6-16S, 6-16KS	
13845	20,000			8K, 8KS	
13850	10,000			8K, 8KS, 8KBS	
13860	35,000			8K, 8KS, 8KBS	
13864	1,000			8K, 8KS	without engraving
13865	1,000			8K, 8KS	without engraving
13866	1,000			8K, 8KS	without engraving

11 Appendix

11.4 Resistance data



NOTE

The data refer to resistance at 20°C.

- no data 1 resistant 2 practically resistant 3 partially resistant 4 not resistant	Concentration	High Density Polyethylene	Polyamide	Polycarbonate	Polyoxymethylene	Polypropylene	Polysulfone	Polyvinyl chloride, hard	Polyvinyl chloride, weak	Polytetrafluorethylene	Acrylonitrile-butadiene-caoutchouc	Aluminium	Medium	Formula	[%]	HDPE	PA	PC	POM	PP	PSU	PVC	PVC	PTFE	NBR	AL
													Medium	Formula	[%]	HDPE	PA	PC	POM	PP	PSU	PVC	PVC	PTFE	NBR	AL
													Acetaldehyde	C ₂ H ₄ O	40	3	2	4	2	3	4	4	-	1	4	1
													Acetamide	C ₂ H ₅ NO	saturated	1	1	4	1	1	4	4	-	1	-	1
													Acetone	C ₃ H ₆ O	100	1	1	4	1	1	4	4	-	1	4	1
													Acrylonitrile	C ₃ H ₃ N	100	1	1	4	3	3	4	4	4	1	4	1
													Allyl alcohol	C ₃ H ₆ O	96	1	3	3	2	2	2	2	4	1	1	1
													Aluminium chloride	AlCl ₃	saturated	1	3	2	4	1	-	1	-	1	1	4
													Aluminium sulfate	Al ₂ (SO ₄) ₃	10	1	1	1	3	1	1	1	1	1	1	1
													Ammonium chloride	(NH ₄)Cl	aqueous	1	1	1	2	1	1	1	1	1	1	3
													Ammonium hydroxide	NH ₃ + H ₂ O	30	1	3	4	1	1	2	1	-	1	-	1
													Aniline	C ₆ H ₇ N	100	1	3	4	1	2	4	4	4	1	4	1
													Anisole	C ₇ H ₈ O	100	3	4	4	1	4	4	2	-	1	4	1
													Antimony trichloride	SbCl ₃	90	1	4	1	4	1	-	1	-	1	-	4
													Benzaldehyde	C ₇ H ₆ O	100	1	3	4	1	1	3	4	4	1	4	1
													Benzene	C ₆ H ₆	100	3	2	4	1	3	4	4	-	1	4	1
													Boric acid	H ₃ BO ₃	aqueous	1	3	1	2	1	-	-	-	1	1	1
													Butyl acrylate	C ₇ H ₁₂ O ₂	100	1	2	4	2	3	4	4	4	1	-	1
													Butyl alcohol, normal	C ₄ H ₁₀ O	100	1	1	2	1	1	2	2	4	1	1	1
													Calcium chloride	CaCl ₂	alcoholic	1	4	2	3	1	-	-	4	1	1	3
													Carbon disulfide	CS ₂	100	4	3	4	2	4	4	4	4	1	3	1
													Carbon tetrachloride (TETRA)	CCl ₄	100	4	4	4	2	4	4	4	4	1	3	1
													Chlorine	Cl ₂	100	4	4	4	4	4	4	4	4	1	-	3
													Chlorine water	Cl ₂ x H ₂ O		3	4	4	4	3	-	3	3	1	-	4
													Chlorobenzene	C ₆ H ₅ Cl	100	3	4	4	1	3	4	4	4	1	4	1
													Chloroform	CHCl ₃	100	3	3	4	4	3	4	4	4	1	4	3

11 Appendix

- no data 1 resistant 2 practically resistant 3 partially resistant 4 not resistant	Medium	Formula	Concentration [%]	High Density Polyethylene	Polyamide	Polycarbonate	Polyoxymethylene	Polypropylene	Polysulfone	Polyvinyl chloride, hard	Polyvinyl chloride, weak	Polytetrafluorethylene	Acrylonitrile-butadiene- caoutchouc	Aluminium
				HDPE	PA	PC	POM	PP	PSU	PVC	PVC	PTFE	NBR	AL
	Chromic acid	CrO ₃	10	1	4	2	4	1	4	1	-	1	4	1
	Chromic potassium sulphate	KCr(SO ₄) ₂ x 12H ₂ O	saturated	1	2	1	3	1	-	1	-	1	-	3
	Citric acid	C ₆ H ₈ O ₇	10	1	1	1	2	1	1	1	1	1	1	1
	Citric acid	C ₆ H ₈ O ₇	50	1	3	1	2	1	-	-	-	1	1	1
	Copper sulphate	CuSO ₄ x 5H ₂ O	10	1	1	1	1	1	1	1	1	1	1	4
	Cyclohexanol	C ₆ H ₁₂ O	100	1	1	3	1	1	1	1	4	1	2	1
	Decane	C ₁₀ H ₂₂	100	-	1	2	1	3	-	-	-	1	2	1
	Diaminoethane	C ₂ H ₈ N ₂	100	1	1	3	1	1	-	3	4	1	1	1
	Diesel fuel	—	100	1	1	3	1	1	-	1	3	1	1	1
	Dimethyl formamide (DMF)	C ₃ D ₇ NO	100	1	1	4	1	1	4	3	-	1	3	1
	Dimethyl sulfoxide (DMSO)	C ₂ H ₆ SO	100	1	2	4	1	1	4	4	-	1	-	1
	Dimethylaniline	C ₈ H ₁₁ N	100	-	3	4	2	4	-	-	-	1	-	1
	Dioxane	C ₄ H ₈ O ₂	100	2	1	4	1	3	2	3	4	1	3	1
	Dipropylene glycol (mono)methyl ether	C ₄ H ₁₀ O	100	3	1	4	1	4	4	4	4	1	-	1
	Ethyl acetate	C ₄ H ₈ O ₂	100	1	1	4	1	1	4	4	4	1	4	1
	Ethylene chloride	C ₂ H ₄ Cl ₂	100	3	3	4	1	3	4	4	4	1	-	1
	Ferrous chloride	FeCl ₂	saturated	1	3	1	3	1	1	1	1	1	-	4
	Formaldehyde solution	CH ₂ O	30	1	3	1	1	1	-	-	-	1	2	1
	Formic acid	CH ₂ O ₂	100	1	4	3	4	1	3	3	1	1	2	1
	Furfural	C ₅ H ₄ O ₂	100	1	3	3	2	4	-	-	-	1	4	1
	Gasoline	C ₅ H ₁₂ - C ₁₂ H ₂₆	100	2	1	3	1	3	3	2	-	1	1	1
	Glycerol	C ₃ H ₈ O ₃	100	1	1	3	1	1	1	1	2	1	1	1
	Heptane, normal	C ₇ H ₁₆	100	2	1	1	1	2	1	2	4	1	1	1
	Hexane, n-	C ₆ H ₁₄	100	2	1	2	1	2	1	2	4	1	1	1
	Hydrogen chloride	HCl	5	1	4	1	4	1	1	1	-	1	2	4
	Hydrogen chloride	HCl	concentrated	1	4	4	4	1	1	2	3	1	4	4
	Hydrogen peroxide	H ₂ O ₂	3	1	3	1	1	1	1	1	-	1	3	3
	Hydrogen peroxide	H ₂ O ₂	30	1	4	1	4	1	1	1	-	1	3	3
	Hydrogen sulphide	H ₂ S	10	1	1	1	1	1	1	1	3	1	3	1
	Iodine, tincture of	I ₂		1	4	3	1	1	-	4	4	1	1	1

11 Appendix

- no data 1 resistant 2 practically resistant 3 partially resistant 4 not resistant	Medium	Formula	Concentration [%]	High Density Polyethylene	Polyamide	Polycarbonate	Polyoxymethylene	Polypropylene	Polysulfone	Polyvinyl chloride, hard	Polyvinyl chloride, weak	Polytetrafluorethylene	Acrylonitrile-butadiene- caoutchouc	Aluminium
				HDPE	PA	PC	POM	PP	PSU	PVC	PVC	PTFE	NBR	AL
	Isopropyl alcohol	C ₃ H ₈ O	100	1	1	1	1	1	1	1	4	1	-	2
	Lactic acid	C ₃ H ₆ O ₃	3	1	3	1	2	1	1	2	-	1	1	1
	Magnesium chloride	MgCl ₂	10	1	1	1	1	1	1	1	1	1	1	1
	Mercuric chloride	HgCl ₂	10	1	4	1	3	1	1	1	1	1	1	4
	Mercury	Hg	100	1	1	1	1	1	1	1	3	1	1	3
	Methyl acetate	C ₃ H ₆ O ₂	100	1	1	4	2	1	-	4	4	1	-	1
	Methyl alcohol	CH ₄ O	100	1	2	4	1	1	3	1	3	1	2	1
	Methyl benzene	C ₇ H ₈	100	3	1	4	1	3	4	4	4	1	4	1
	Methyl ethyl ketone (MEK)	C ₄ H ₈ O	100	1	1	4	1	1	4	4	4	1	4	1
	Methylene chloride	CH ₂ Cl ₂	100	4	3	4	3	3	4	4	4	1	-	1
	Mineral oil	—	100	1	1	1	1	1	1	1	-	1	1	1
	Nitric acid	HNO ₃	10	1	4	1	4	1	1	1	-	1	4	3
	Nitric acid	HNO ₃	100	4	4	4	4	4	-	4	-	1	4	1
	Nitrobenzene	C ₆ H ₅ NO ₂	100	3	4	4	3	2	4	4	4	1	4	1
	Oleic acid	C ₁₈ H ₃₄ O ₂	100	1	1	1	2	1	-	1	-	1	3	1
	Oxalic acid	C ₂ H ₂ O ₄ x 2H ₂ O	100	1	3	1	4	1	1	1	1	1	2	1
	Ozone	O ₃	100	3	4	1	4	3	1	1	-	1	4	2
	Petroleum	—	100	1	1	3	1	1	1	1	3	1	1	1
	Phenol	C ₆ H ₆ O	10	1	4	4	4	1	4	1	3	1	3	1
	Phenol	C ₆ H ₆ O	100	2	4	4	4	1	3	4	3	1	3	1
	Phosphoric acid	H ₃ PO ₄	20	1	4	2	4	1	-	-	-	1	2	4
	Phosphorus pentachloride	PCl ₅	100	-	4	4	4	1	-	4	4	1	-	1
	Potassium hydrogen carbonate	CHKO ₃	saturated	1	1	2	1	1	-	-	-	1	-	4
	Potassium hydroxide	KOH	30	1	1	4	3	1	1	1	1	1	-	4
	Potassium hydroxide	KOH	50	1	1	4	3	1	1	1	1	1	-	4
	Potassium nitrate	KNO ₃	10	1	1	1	1	1	-	-	-	1	1	1
	Potassium permanganate	KMnO ₄	100	1	4	1	1	1	-	1	-	1	3	1
	Pyridine	C ₅ H ₅ N	100	1	1	4	1	3	4	4	4	1	4	1
	Resorcinol	C ₆ H ₆ O ₂	5	1	4	2	3	1	4	2	-	1	-	2
	Silver nitrate	AgNO ₃	100	1	1	1	1	1	1	1	1	1	2	4

11 Appendix

- no data 1 resistant 2 practically resistant 3 partially resistant 4 not resistant	Concentration	High Density Polyethylene	Polyamide	Polycarbonate	Polyoxymethylene	Polypropylene	Polysulfone	Polyvinyl chloride, hard	Polyvinyl chloride, weak	Polytetrafluorethylene	Acrylonitrile-butadiene-caoutchouc	Aluminium	
													Medium
Sodium bisulphite	NaHSO ₃	10	1	1	2	4	1	-	-	-	1	1	1
Sodium carbonate	Na ₂ CO ₃	10	1	1	1	1	1	-	-	-	1	-	3
Sodium chloride	NaCl	30	1	1	1	1	1	1	1	1	1	1	3
Sodium hydroxide	NaOH	30	1	1	4	1	1	1	1	1	1	2	4
Sodium hydroxide	NaOH	50	1	1	4	1	1	1	1	-	1	2	4
Sodium sulfate	Na ₂ SO ₄	10	1	1	1	1	1	1	1	1	1	1	1
Spirits	C ₂ H ₆ O	96	1	1	1	1	1	1	1	3	1	-	1
Styrene	C ₈ H ₈	100	4	1	4	1	3	-	4	4	1	4	1
Sulphuric acid	H ₂ SO ₄	6	1	4	1	4	1	1	1	-	1	2	3
Sulphuric acid	H ₂ SO ₄	fuming	4	4	4	4	4	4	4	4	1	4	3
Tallow	—	100	1	1	1	1	1	-	1	1	1	1	1
Tetrahydrofuran (THF)	C ₄ H ₈ O	100	3	1	4	1	3	4	4	4	1	3	1
Tetrahydronaphthalene	C ₁₀ H ₁₂	100	3	1	4	1	4	4	4	4	1	-	1
Thionyl chloride	Cl ₂ SO	100	4	4	4	2	4	4	4	4	1	-	3
Tin chloride	SnCl ₂	10	1	4	2	2	1	-	-	-	1	1	4
Transformer oil	—	100	1	1	3	3	1	1	1	-	1	1	1
Trichloroethane	C ₂ H ₃ Cl ₃	100	3	3	4	2	4	4	4	4	1	4	4
Urea	CH ₄ N ₂ O	10	1	1	1	1	1	-	-	-	1	1	1
Urine	—	100	1	1	1	1	1	-	1	1	1	-	2
Vinegar	C ₂ H ₄ O ₂	10	1	4	1	1	1	1	1	1	1	2	1
Vinegar	C ₂ H ₄ O ₂	90	1	4	4	4	1	3	1	4	1	-	1
Wax	—	100	-	1	1		1	-	-	-	1	-	1
Wines	—	100	1	1	1	2	1	1	1	1	1	-	4
Xylene	C ₈ H ₁₀	100	3	1	4	1	4	4	4	4	1	4	1

11 Appendix

11.5 EC declaration of conformity



EC – DECLARATION OF CONFORMITY

The product named hereinafter was developed, designed, and manufactured in compliance with the relevant, fundamental safety and health requirements of the listed EC directives and norms. In the event of modifications that were not authorised by us or if the product is used in a manner that is not in line with the intended purpose, this declaration will be rendered void.

<i>Product name:</i>	Laboratory Centrifuge
<i>Product type:</i>	Sigma 2-7
<i>Order number:</i>	10226
<i>Directives:</i>	2006/42/EG Machinery Directive 2006/95/EG Low Voltage Directive 2004/108/EG EMC Directive 2011/65/EU RoHS Directive
<i>Normes:</i>	EN 61010-2-020:2006 EN 61000-3-2:2006, A1:2008, A2 :2009 EN 61000-3-3:2013 EN 61326-1:2013

Sigma Laborzentrifugen GmbH An der Unteren Söse 50 37520 Osterode Germany	Authorised Representative for the documentation: Eckhard Tödteberg
Osterode, 16 July 2015  General Manager	

2-7_2015-07-16_en.docx

11 Appendix



EC – DECLARATION OF CONFORMITY

The product named hereinafter was developed, designed, and manufactured in compliance with the relevant, fundamental safety and health requirements of the listed EC directives and norms. In the event of modifications that were not authorised by us or if the product is used in a manner that is not in line with the intended purpose, this declaration will be rendered void.

<i>Product name:</i>	Laboratory Centrifuge
<i>Product type:</i>	Sigma 2-7 IVD
<i>Order number:</i>	10227
<i>Directives:</i>	98/79/EC In vitro Diagnostica 2011/65/EU RoHS Directive
<i>Normes:</i>	EN 61010-2-101:2002 EN 61010-2-020:2006 EN 61000-3-2:2006, A1:2009, A2:2009 EN 61000-3-3:2013 EN 61326-1:2013

Sigma Laborzentrifugen GmbH An der Unteren Söse 50 37520 Osterode Germany	Authorised Representative for the documentation: Eckhard Tödteberg
Osterode, 28 July 2015  General Manager	

2-7_IVD_2015-07-28_en.docx

11 Appendix

12 Index

A

Acceleration time	
- see also the softstart and softstop function	
.....	35
Accessories, cleaning and care.....	44
Acid.....	19, 43, 44
Adapters	30, 44
Alkaline solutions	19, 43, 44
Ambient conditions.....	53
Ambient temperature	53
Anodised coating	44
Application examples	12
Autoclaving	47
Automatic lid opening function	35

B

Bucket.....	30
Buckets, cleaning and care	45
Button signal	36

C

Calling up stored programs	37
Capacity.....	52
Carrier systems.....	30
Carriers, cleaning and care	45
CE mark in compliance with the directive 2006/42/EC	14
Centrifugation of infectious, toxic, radioactive, or pathogenic substances.....	18
Centrifugation principle	12
Centrifugation with different tube sizes.....	28
Centrifugation with low capacity.....	28
Centrifuge cannot be started.....	38
Centrifuge decelerates during operation	38
Centrifuge, cleaning and care	43
Changes in colour.....	47
Changes in structure.....	47
Changing the runtime during centrifugation	33
Changing the Speed/RCF Value during Centrifugation.....	32
Chemical and biological safety.....	18
Chemical resistance of plastic.....	44
Cleaning agents.....	46
Cleaning the bores of angle rotors	44

Cleaning the centrifuge	43
Closing the lid	17, 26
Clotting time.....	35
Communication error	41
Condensation.....	25
Connected load.....	52
Contamination.....	18, 44
Continuous heat resistance.....	46
Continuous run	34
Copyright	9
Corrosion	17, 20, 30, 43, 44, 45
Cost estimate.....	49
Cracking	44
Cracks	45
Current consumption.....	52
Customer provided fuses	25
Cycles.....	27

D

Damage of the surface.....	45
Dangerous goods.....	19
Dangerous materials.....	46
Deceleration time	
- see also the softstart and softstop function	
.....	35
Declaration of conformity	62
Declaration of decontamination.....	49
Declaration of Decontamination	51
Decontamination agent.....	44, 46
Deformation of tubes.....	47
Density.....	19
Different service life of rotors and accessories	
.....	20, 57
Dimensions	23
Direct hazard to the life and health.....	15
Directive 2002/96/EC	51
Disinfectants	46
Disinfection of the rotor chamber and accessories	46
Disposal of the centrifuge.....	51
Disposal of the packaging	51
Documentation.....	9

Index

E	
Earth conductor check	22
EC declaration of conformity	62
EEPROM error.....	41
Electrical connection	52
Electrical safety.....	17
EMC as per EN 61326	52
Emergency lid release.....	39
Error correction	38
Error message	38
Explanation of the symbols and notes.....	15
Explosive substances	18
F	
Fatal error	38
Fire preventions	18
Form for the return of defective parts	49
Functional and operating elements	10
G	
General conditions	8
General malfunctions	38
Glass breakage.....	45
Glass particles	45
Gravitational field	52
Grease for load bearing bolts.....	43
H	
Hazard warnings.....	8, 27, 30
Highly corrosive substances	17
I	
Imbalance	28, 30
Imbalance error.....	41
Importance of the operating manual.....	8
Important information	15
Infectious substances	46
Inflammable substances	18
Informal safety instructions	16
Initial start-up	26
Input fuse.....	52
Inspection by the manufacturer.....	48
Installation of accessories	28
Installation of rotors and accessories	27
Installation of the rotor.....	27
Installation site	25
Intended use.....	8
Interrupting a centrifugation run	32
Interrupting a deceleration process	32
IP code	52
L	
Layout of the centrifuge.....	10
Leaks.....	47
Lid error	41
Lid is not closed correctly	38
Lid lock device	20
Lid lock is not closed correctly.....	38
M	
Mains powerswitch off.....	38
Mains voltage.....	17
Maintenance	43
Malfunction	38
Malfunctions and error correction.....	38
Manual release of the lid lock.....	39
Manufacturer.....	52
Marking of the unit	14
Measures in the event of hazards and accidents.....	22
Mechanical safety	17
Mode of operation.....	12
Motor error	41
Motor shaft.....	43
N	
Name plate	11
No indication on the display	38
No power in the mains supply	38
Noise level	52
Notes on safety and hazards.....	8
Notes on transport	23
O	
Online download of forms	50
Opening the lid.....	26
Operating personnel	16
Operating voltage.....	25
Operational safety.....	44
Overseas shipping	23
P	
Packaging	24
Parameter error.....	41
Pathogenic substances.....	18, 43, 46

Plastic accessories, cleaning and care.....	44	Scope of supply	9
Potential hazard to the life and health	15	Serial number	11, 42, 48
Potentially hazardous situation.....	15	Service.....	48
Power consumption	52	Service contact	42
Power cord is not plugged in.....	38	Service life	43
Pressure marks.....	45	Service life of rotors and accessories... 20, 57	
Prevention of accidents.....	8	Service life of the accessories.....	47
Problem description	49	Service work	48
Process error	41	Set-up and connection	25
Programs	37	Short run	33
Protection class.....	25, 52	Slushing oil	9
Q		Softstart and softstop function.....	35
Quick run	33	Solvents.....	19, 43, 44
R		Sound signal	36
Radioactive substances	18, 43	Spare part enquiries.....	42
Radius	13	Speed	13, 32, 52
Range of accessories	54	Speed-gravitational-field-diagram	56
RCF	32	Speedometer error.....	41
Relative centrifugal force (RCF).....	13, 32	Spincontrol Basic	31
Remove glass particles and metal dust from the rotor chamber	45	Standards and regulations	9
Responsibility of the operator.....	16	Standstill monitoring system	21
Return of centrifuges, spare parts, or accessories	49	Start delay.....	35
Return of defective parts.....	49	Starting a centrifugation run	32
Risk of electrical shock.....	17	Sterilisation of the rotor chamber and accessories	46
Rotor chamber	43	Storage and transport	23
Rotor radii	55	Storage conditions	23
Rotor selection.....	34	Storage temperature	23
Rotor tie-down screw	45	Stress-corrosion see	
Rotors and accessories with a different service life	20, 57	corrosion.....	45
Rotors, cleaning and care	45	Structural changes.....	18
Runtime	33	Supply voltage	25
S		Switching the centrifuge off	37
Safety area	19	System check	22
Safety devices	20	System error	41
Safety distance	17, 19, 25	T	
Safety instructions.....	8, 27, 30	Table of error codes.....	41
Safety instructions for centrifugation	19	Table of rotors and accessories with a different service life	20, 57
Safety, chemical and biological.....	18	Technical data	52
Safety, electrical.....	17	Technical documentation	53
Safety, mechanical.....	17	Temperature error.....	41
Saving the current settings.....	37	Temperature value cannot be reached.....	38
		Thermal stress	43

Index

Toxic substances 18, 43
Transport safety device 24
Type 52
Type of connection 25
Type of the centrifuge 42, 48

U

Units of protection class I 25
User interface 31
UV radiation 25, 43

V

Vents 25

W

Warranty and liability 8
Wear 48
Weight 23
Work on the power supply system 17

Y

Year of manufacture 11