

UV-VIS Spectrophotometer

UV-1800



UV-1800

UV-VIS Spectrophotometer



Contents

Highest resolution (1 nm)	P. 4
Space-saving design	P. 6
USB memory ready	P. 8
Greater operability	P. 10
Variety of measurement modes	P. 12
Control with UVProbe Software	P. 14
Accessories	P. 16
Specifications	P. 24

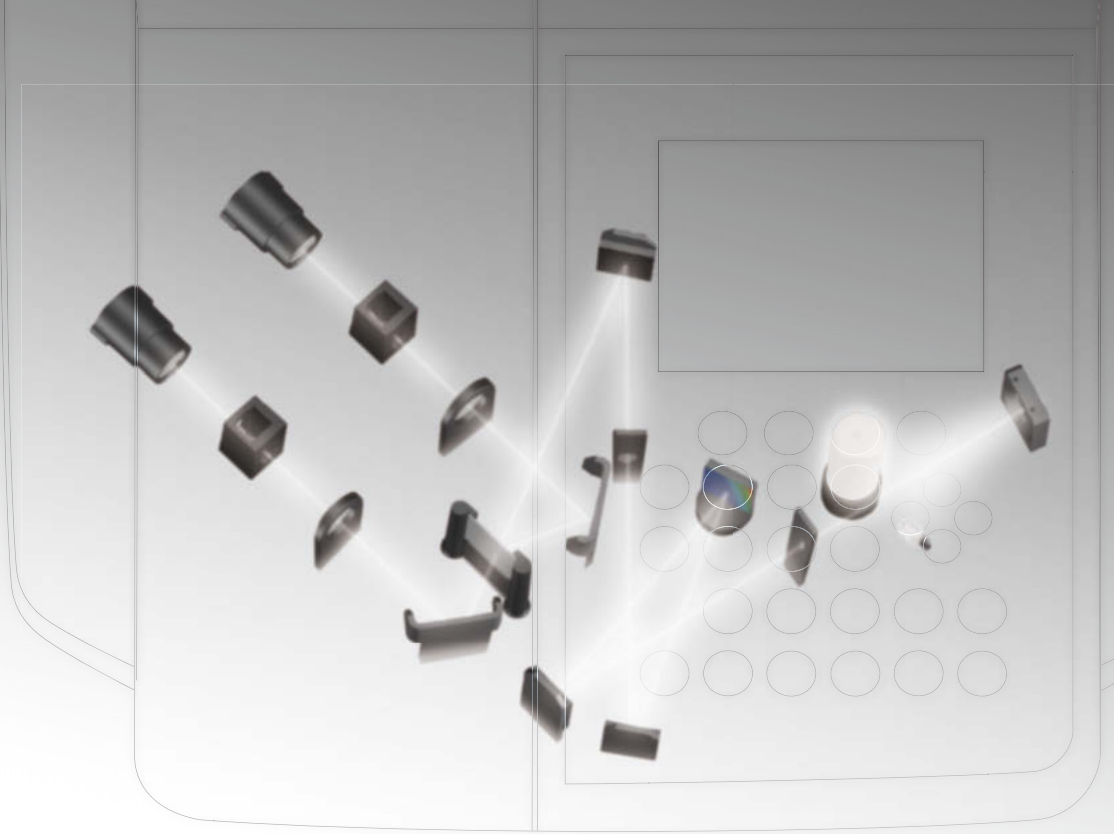

High resolution ————— Resolution of 1 nm is best in its class

Space reductions ————— Small installation area: 450 (W) × 490 (D) mm

Improved operability ————— Equipped with USB terminal

A compact, double-beam UV-VIS spectrophotometer wrapped in a sleek form.

The UV-1800 uses the Czerny-Turner mounting for its monochromator, and boasts the highest resolution in its class*, a bright optical system, and a compact design.

Available as either a stand-alone instrument or a PC-controlled instrument, the UV-1800 is USB-memory ready, which enables users to save measurement data to highly versatile USB memory, and perform data analysis and printing using a PC.

*As of March 2007, according to Shimadzu research.

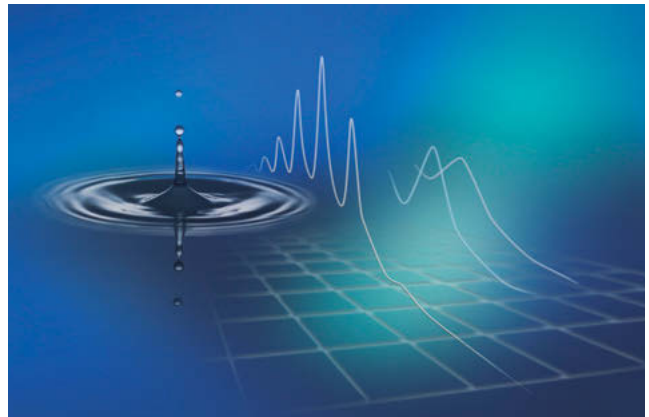

Highest resolution in its class - 1 nm

In addition to achieving a resolution of 1 nm, the highest in its class, by using a monochromator with a Czerny-Turner mounting, the UV-1800 also features a compact, bright optical system. Having a resolution of 1 nm makes it easy to satisfy the standards of wavelength resolution demanded by the European Pharmacopoeia. The UV-1800 also conforms to the specifications demanded by the Japanese Pharmacopoeia in relation to wavelength accuracy and photometric accuracy. Additionally, hardware validation based on the Japanese Pharmacopoeia can be performed using validation software that is incorporated as a standard feature and an optical filter for wavelength calibration that is calibrated at a bandwidth of 1 nm.

The wavelength accuracy can be checked precisely using an optical filter designed for this purpose.

The spectrum and peak detection results obtained for NIST SRM 2034 Holmium Oxide Solution which is used as a wavelength standard, are shown below.

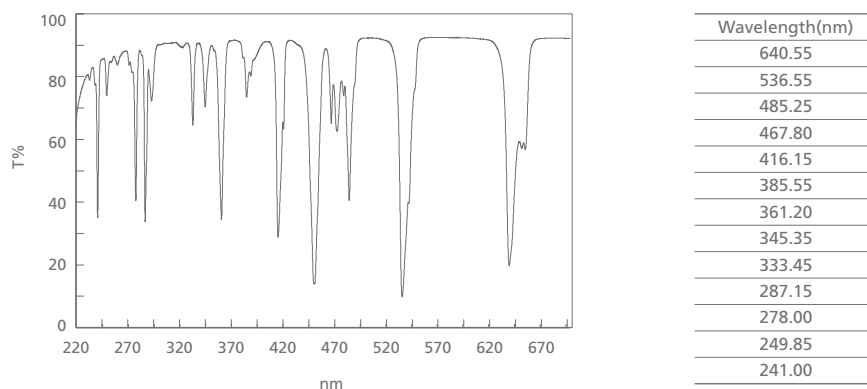

Spectrum of Benzene/Ethanol Solution

Benzene exhibits a sharp absorption waveform in the neighborhood of 250 nm. With such a waveform, there is a large difference between the spectra obtained at resolutions of 1 nm and 2 nm.

Spectra obtained for benzene/ethanol solution using the UV-1800 and an instrument with a resolution (bandwidth) of 2 nm are shown below. Due to the difference in resolution, differences in peak intensity of up to 40% can be observed.

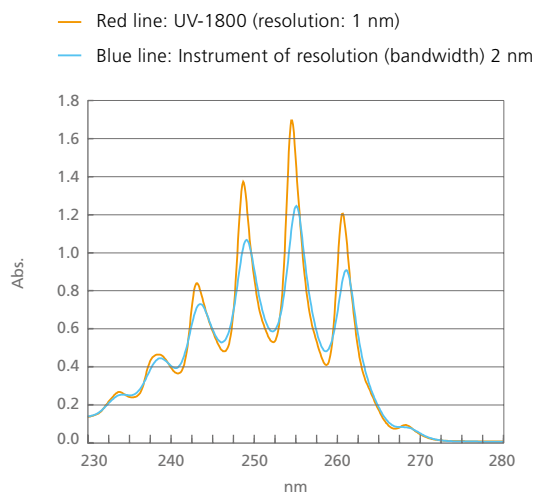

Spectrum of Toluene/Hexane Solution

Using the ratio of the peak value obtained in the neighborhood of 269 nm for toluene/hexane solution and the valley value obtained in the neighborhood of 266 nm as an indicator of resolution, the European Pharmacopoeia demands a ratio more than 1.5. The ratio for the spectrum shown below is 1.94, illustrating the ease with which the UV-1800 satisfies the standards of wavelength resolution demanded by the European Pharmacopoeia.

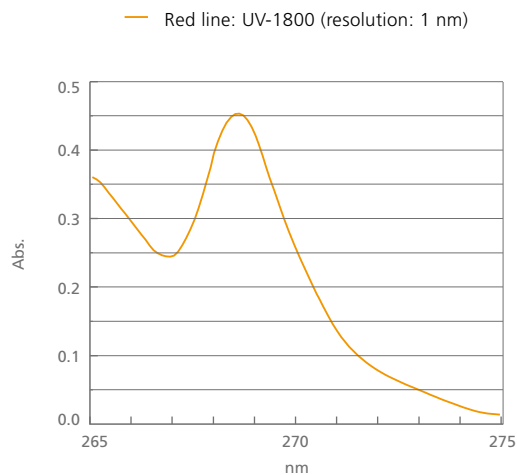

Space-saving design

The width of the UV-1800 is 450 mm, making it one of the most compact instruments in its class. This allows installation in tight spaces. Open up the last two pages of this catalog to get a better idea of the dimensions.

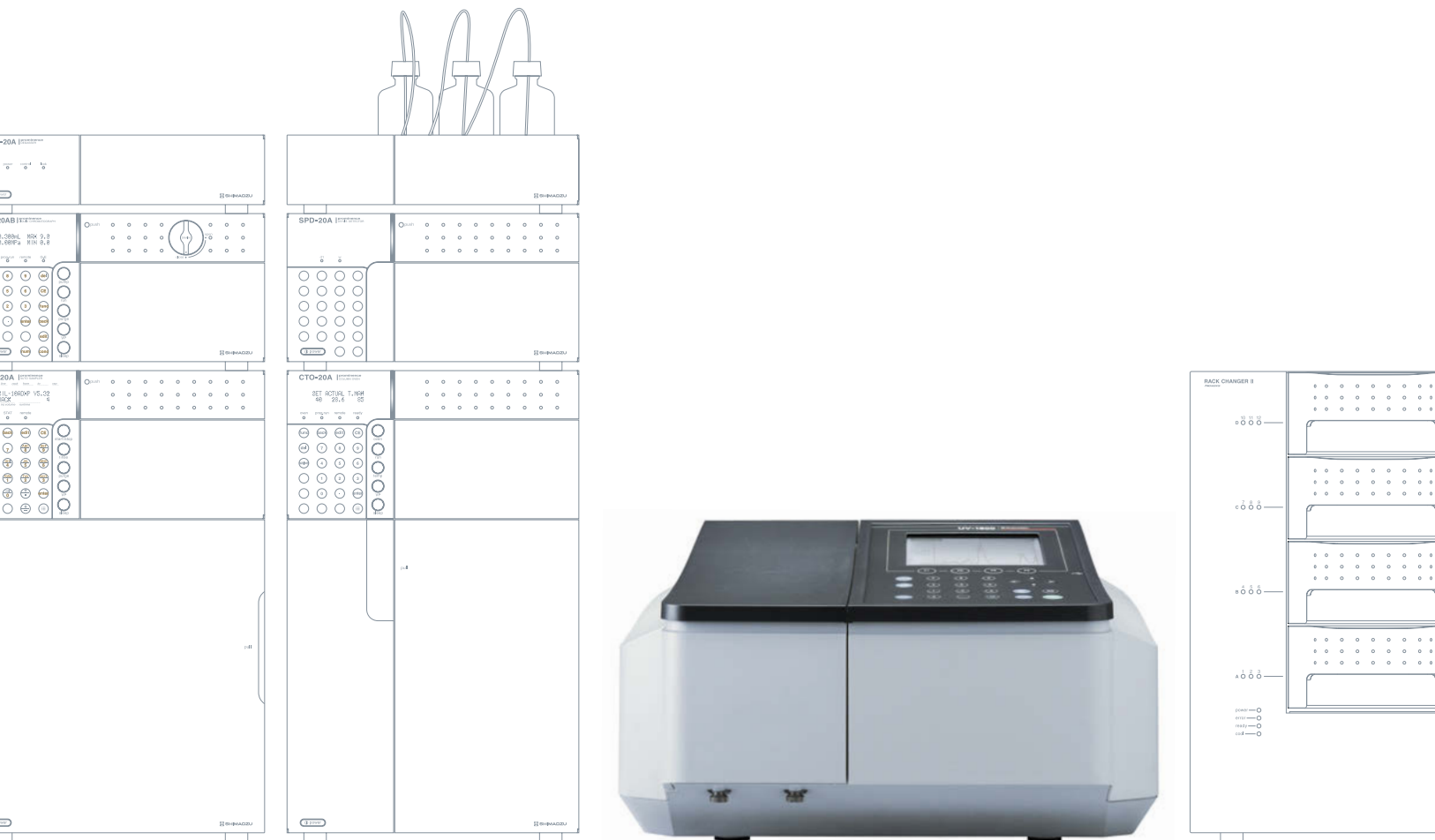

The installation area is smaller.

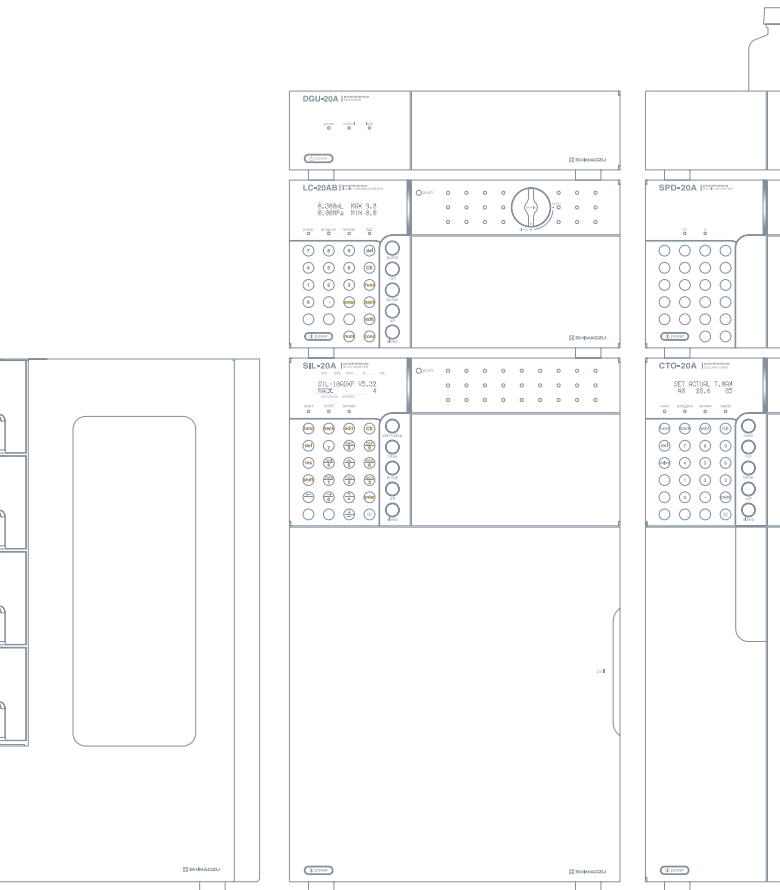

UV-1800

450(W) × 490(D) × 270(H)

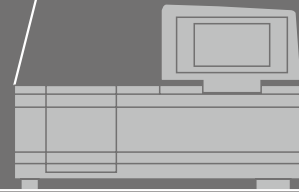

UV-1700

550(W) × 470(D) × 200~380(H)

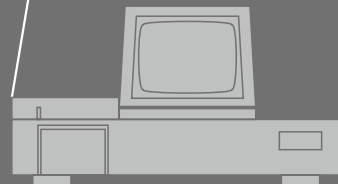

UV-160

630(W) × 500(D) × 450(H)

Data operability is expanded by the use of USB memory

Using USB memory makes it easy to transport analysis data and to store large amounts of data in a PC.

*USB memory can be connected directly to the UV-1800.

Data for spectra and time-course curves can be displayed and saved with commercial spreadsheet software.



UVProbe PC software (provided as standard) makes data processing easy.



USB memory + PC + UVProbe (provided as standard)

Using UVProbe control/data processing PC software makes it possible to directly read data that is transferred to the PC.

UVProbe

An all-in-one software product that has the following four functions:

- Spectrum mode
- Photometric mode (including quantitation)
- Kinetics mode (time-course measurement of photometric values and enzymatic activity operations)
- Report Generator (printing and creation of printing template)

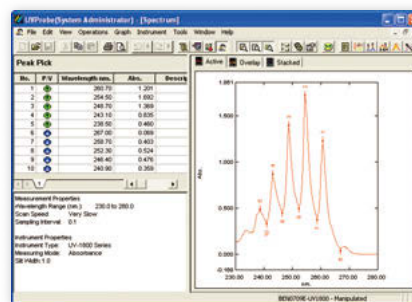

USB memory + PC + UVProbe (provided as standard) + Printer

- Spectra and data can be freely combined and arranged.
- The thickness and color of spectral lines and the size of characters can be set freely.
- Labels can be attached to spectra.
- Registering layouts as templates allows reports to be printed with a single operation.

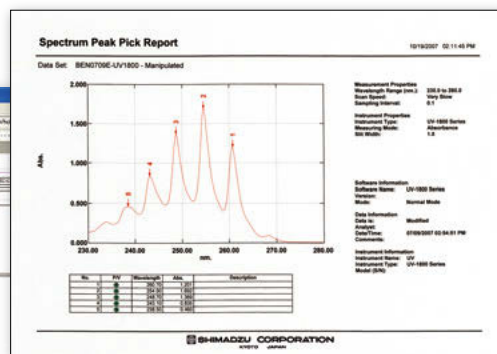
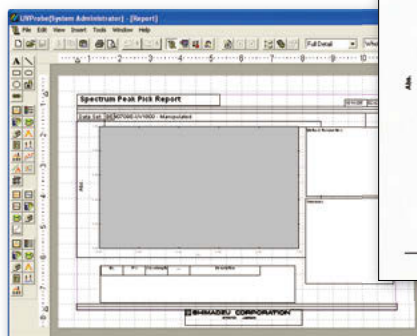

Data can be read with commercial spreadsheet software.



With the UV-1800, the curve-related data (spectra and time-course curves) that are obtained can be converted to, and saved in, CSV format. Transferring this data with USB memory allows it to be read directly at a PC using commercial spreadsheet software.

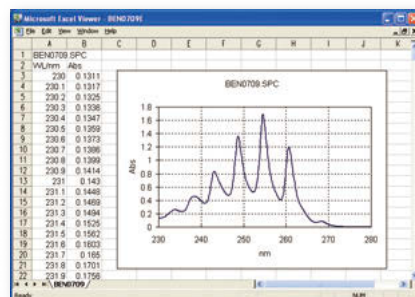

*The above spectrum was created with Microsoft® Excel graph functions after the data was read. (Example of reading using Microsoft® Excel)

USB memory ready

The functions available with earlier instruments have been improved to give greater operability

Printing is possible using a greater number of printers.



UV-1800 + MPU screen copy printer (option)

Prints hard copies of screens and numerical data. The items displayed on the screen, such as spectra and calibration curves, can be printed.

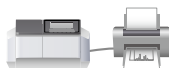

UV-1800 + Commercial printer (option)

Printing is possible to printers that support ESC/P-9, ESC/P-24, ESC/P Raster, and PCL control codes.

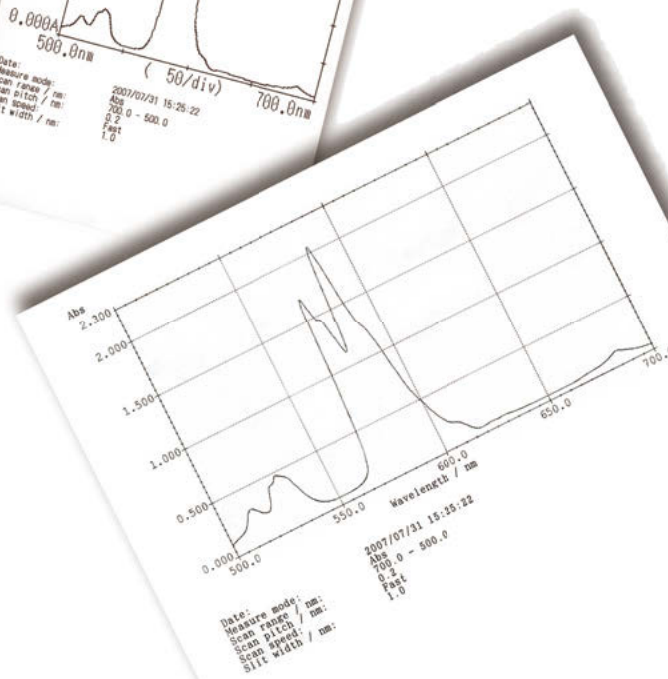
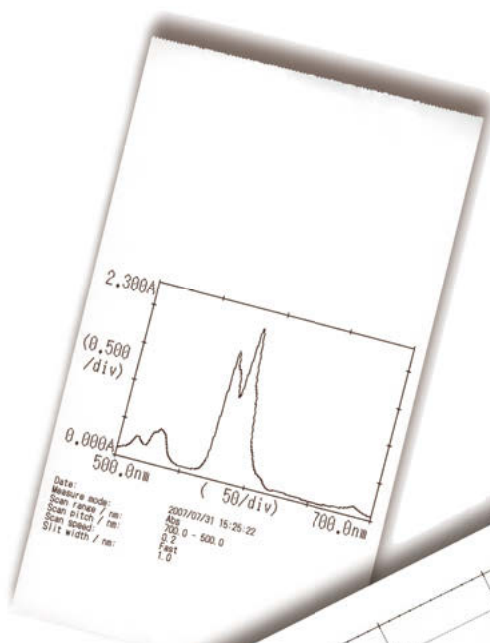

New Function Security functions have been improved.

Enabling the UV-1800 security functions makes it possible to restrict functions according to the user level.

■ Users can log in as:

- Administrator
- Developer
- Operator

Three different authorization levels can be set in accordance with these user classifications.

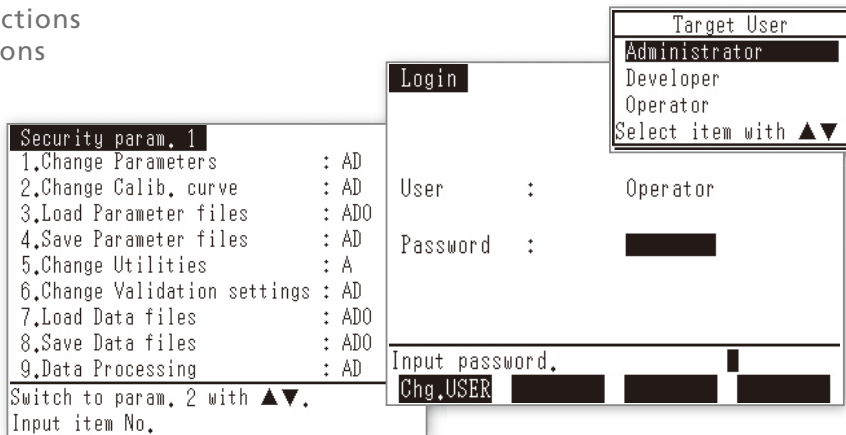

Instrument validation and maintenance/inspection functions have been enhanced.

Instrument Validation Functions

- The checks for nine JIS items can be performed automatically or semi-automatically.
- The stray-light check performed using aqueous potassium chloride (KCl) solution and the resolution check performed using toluene/hexane solution specified by the European Pharmacopoeia are possible.
- Linking with a 6-series multi-cell (optional) is possible, making sample replacement unnecessary. Inspections can be performed efficiently.

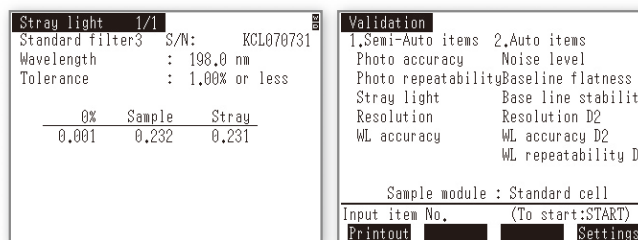

Instrument Maintenance and Inspections

- The usage times of the deuterium (D2) lamp and the halogen (WI) lamp can be recorded and displayed, which enables users to ascertain the expected replacement period of the lamps when performing periodic inspections.

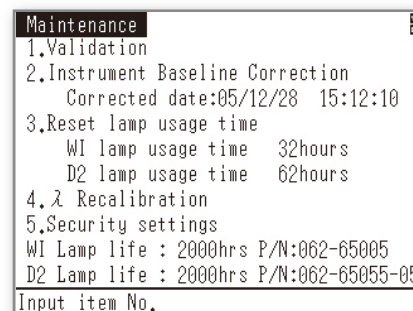

From photometric to protein quantitation: Equipped with a variety of measurement modes as a standard feature

1. Photometric Mode

Measures the absorbance or transmittance at a single wavelength or multiple (up to eight) wavelengths. In multiple-wavelength measurement, calculations can be performed on the data obtained

for up to four wavelengths, including the calculation of the difference between, or ratio of, the measurements obtained for two wavelengths.

2. Spectrum Mode

A sample spectrum is recorded using wavelength scanning. Repeat scans let you follow sample changes over time. Zoom in on the finished spectrum for a better view, then use the peak/valley pick

function to select maxima and minima, and perform a wide variety of data processing functions.

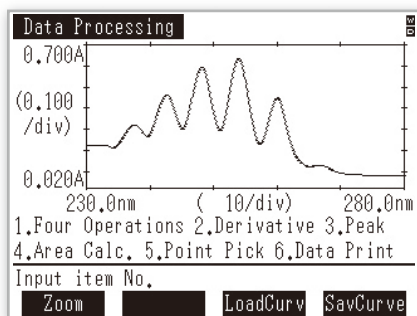
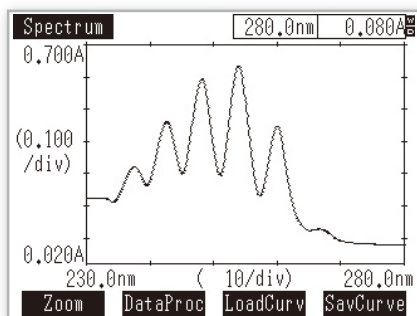

λ (nm)	Abs	λ (nm)	Abs
266.50	0.128		
260.00	0.447		
253.90	0.634		
248.10	0.593		
242.50	0.461		
237.50	0.320		
232.70	0.223		

3. Quantitation Mode

Generates a calibration curve from the measurement of standards, and then calculates the concentrations of unknowns. Allows various combinations of wavelength number (1 to 3 wavelengths and

derivatives) and calibration curves (K-factor and first-to-third order).

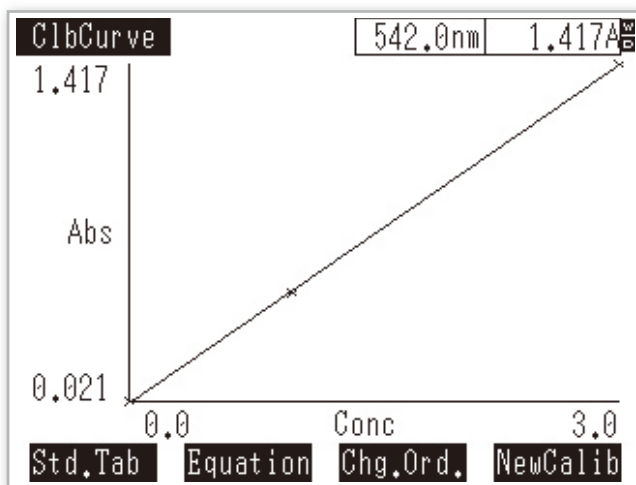

Smpl No.	Abs	Conc. (mg/ml)
1	0.911	1.9241
2	0.908	1.9176
3	0.482	1.0047
4	0.475	0.9897
5	0.488	1.0176
6	0.479	0.9983
7	0.485	1.0112
8	0.652	1.3690

4. Kinetics Mode

Measures absorbance changes as a function of time, and obtains the enzymatic activity values. The kinetics measurement method or the rate measurement method can be selected. When using the

MMC-1600/1600C Multi-Cell Holder (8/16 cells) or the CPS-100 Cell Positioner (6 cells), multiple samples can be measured at the same time.

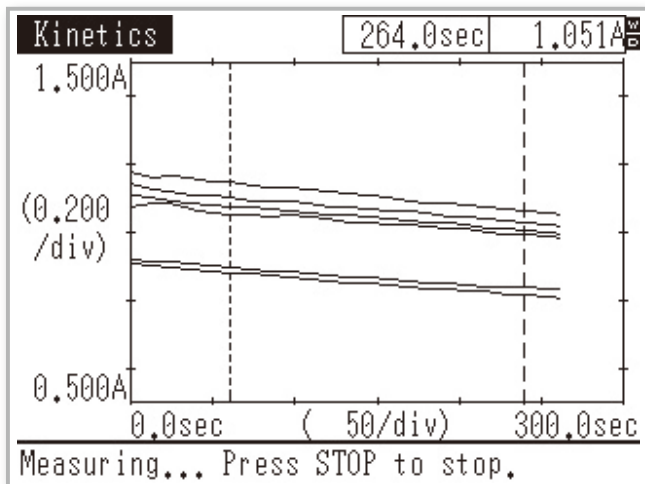

Kinetics		340.0nm	1.038A
Smp No.	Init(Abs)	$\Delta A/\text{min}$	Activ.
1- 1	0.906	-0.0225	134.93
1- 2	0.921	-0.0208	125.00
1- 3	1.074	-0.0209	125.58
1- 4	1.106	-0.0240	143.89
1- 5	1.144	-0.0237	142.30
1- 6	1.176	-0.0277	166.06
2			

Press START to measure. (CE:Delete data)

Smpl No. Curve DataDisp SaveData

5. Time Scan Mode

Measures the change in absorbance, transmittance or energy as a function of time. When using the MMC-1600/1600C Multi-Cell Holder (8/16 cells) or the CPS-100 Cell Positioner (6 cells), multiple samples can be measured at the same time.

6. Multi-Component Quantitation Mode

Quantitates up to eight components mixed in a single sample. The calibration equation is determined using pure or mixed components with known values.

7. Biomethod Mode

Capable of determining DNA and protein concentrations using the following quantitation methods.

DNA/Protein Quantitation

Quantitates DNA or protein using the absorbance at 260/230 nm or 260/280 nm.

Protein Quantitation

- Lowry method
- BCA method (method using Bicinchoninic Acid)
- CBB method (method using Coomassie Brilliant Blue G-250)
- Biuret method
- UV Absorption method (direct measurement at 280 nm)

DNA Quantitation		320.0nm	0.001A
Smpl No. = 1			
A1(260.0)	=	0.307	
A2(280.0)	=	0.232	
Ab(320.0)	=	0.110	
Abs Ratio	=	1.6137	
DNA Conc	=	8.0047	
Protein Conc	=	40.315	

Press START to measure. (CE:Delete data)

Smpl No. DataDisp SaveData

Control with UVProbe software



Using the UVProbe software provided makes it possible to control the UV-1800 with a PC. UVProbe is an all-in-one software product that includes the following four functions: Spectrum mode, Photometric (quantitation) mode, Kinetics (time-course) mode, and a superb Report Generator.

(A USB cable is required for connection to the PC.)

A Variety of Data Processing and Calculation Functions

- Data processing operations, such as peak detection and area calculation, and data conversion operations, such as integration and interpolation, can be applied to spectra and time-course data.
- With the kinetics module, the Michaelis constant (Km) or the maximum response speed (Vmax) can be calculated and plotted.

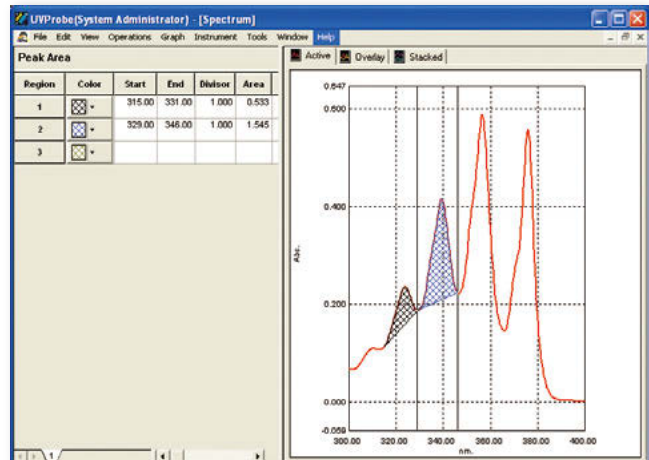
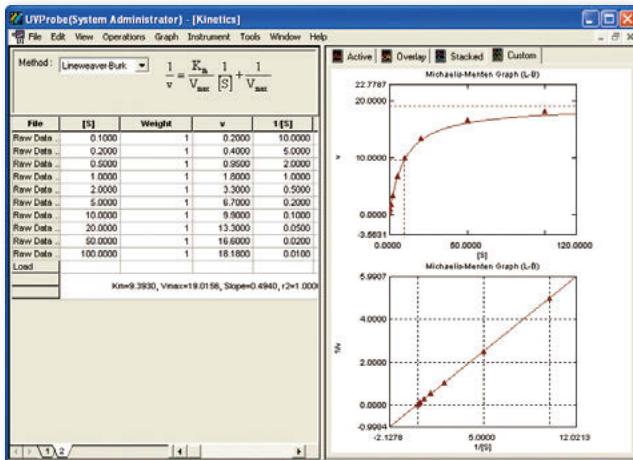

Calculation Expressions and QA/QC Functions

- With the photometric module, calculation expressions can be defined for measurement results.
- Judgment expressions can be created for photometric values and calculation results.

Sample ID	Type	WL 580.0	WL 600.0	WL 375.0	WL 570.0_400.0	PF	Comments
1	1	Link-Repeat	79.75	5.07	38.02	00.43	
2	1-2	Link-Repeat	79.74	5.58	38.52	88.44	
3	1-3	Link-Repeat	79.81	5.39	38.41	88.24	
4	1-Avg	Average	79.77	5.61	38.58	86.37	Pass Avg of preceding 3 Samples
5							

Method Name: PF

Passed Test: Pass Failed Text: Fail Factors...

Equation: [WL570_0_400.0:82.00]/[WL375_0:50.00]/[WL580.0]

Build (double click to add an item to equation)

Columns: WL580.0, WL600.0, WL375.0, WL570_0_400.0

Operator: =, >, <, >=, <=

Entries: Columns, PF

GLP/GMP Compliant

GLP/GMP compliance is supported with the following functions.

- Security Functions

The use of functions can be restricted according to the user level.

- Audit Trail Function

Details of processes (e.g., baseline correction) that affect measurement data are tracked in the instrument's history.

- Data History Function

If a change is made to measurement data, a history of this is added to the data.

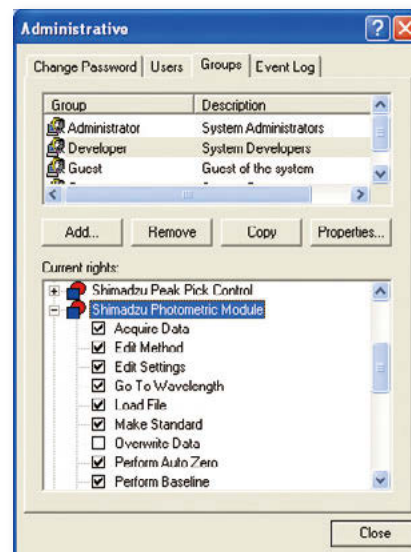
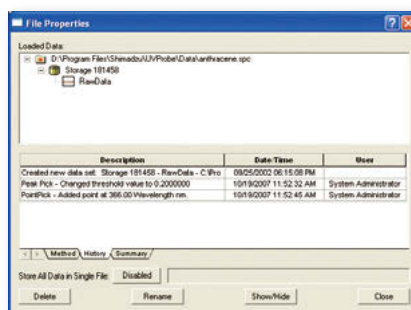

Operating System	Windows 7 Professional
Measurement Modes	Spectrum, Kinetics (time-course measurement), Photometrics (quantitation)
General	Multitasking (simultaneous measurement and data processing, and other types of processing) Customizable measurement screen layout (wavelengths, data display font and font size, colors, displayed number of rows) GLP/GMP compliant (security, history)
Spectrum Mode	Comparison of multiple spectra /relative processing * Spectrum enlargement/shrinking, auto scale and Undo/Redo of these operations Annotation on spectrum screen
Data Processing in Spectrum Mode	Normalization, Point Pick, peak/valley detection, area calculation Transformations: 1st to 4th order derivatives, smoothing, reciprocal, square root, natural log, Abs. to %T conversion, exponential conversion, Kubelka-Munk conversion Ensemble averaging, interpolation, data set and constants arithmetic (between spectra, between spectra and constants)
Photometric (Quantitation) Mode	Single wavelengths, multi wavelengths (includes 1, 2, or 3 wavelengths), and spectrum quantitation (peak, maximum values, area, etc. for specified wavelength ranges) K-factor, single-point calibration curve, and multiple-point calibration curve (1st, 2nd, 3rd order function fitting, pass-through-zero specification) Photometric processing with user-defined functions (+, -, x, ÷, Log, and Exp, etc. functions, including factors) Weight correction, dilution factor correction, and other types of factor-based correction for each sample Averaging of repeat measurement data Simultaneous display of standard table, unknown table and calibration curves Display of Pass/Fail indications based on measurement results
Kinetics (Time-Course Measurement) Mode	Comparison/relative data processing of multiple time-course data* Single or double wavelength measurement (difference or ratio) Simultaneous display of time-course data (curves and measurement data), Michaelis-Menten table, and graphs Enzyme kinetics calculations (for single cells or multi-cells) Michaelis-Menten calculations and graph creation (Michaelis-Menten, Lineweaver-Burk, Hanes, Woolf, Eadie-Hofstee), Dixon plot, Hill plot Data processing (corresponds to spectrum data processing)
Report Generator	Layout and editing of printing templates Quick printing using report templates Insert date, time, text, and drawing objects including lines, circles and rectangles

*Depends on the PC environment (e.g., memory). As a rough guide, 20 to 30 sets of spectral data can be handled.

Accessories

Film Holder (P/N 204-58909)

Used in transmittance measurement of thin samples such as films and filters. Holds thin samples, such as films and filters, for analysis.

■ Sample Size

Minimum: 16 (W) × 32 (H) mm

Maximum: 80 (W) × 40 (H) × 20 (t) mm



Rotating Film Holder (P/N 206-28500-41)

This film holder can rotate samples in a plane centered on the optical axis. Polarizers Type I, II, and III can be attached. The Large Polarizer Set cannot be used.

■ Sample Size

33 mm × 30 mm × 2 mm thick



Four-Cell Sample Compartment Unit

(P/N 206-23670-91)

Accommodates 4-cell holders of various types.

- Incorporates a 4-cell holder for 10-mm square cells.

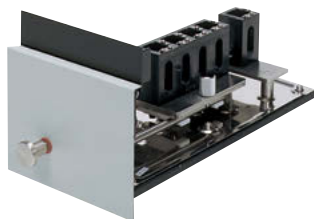

Multi-Cell Sample Compartment

(P/N 206-69160-41)

Holds up to six 10-mm square cells on the sample side. No temperature control capability.

- Number of cells: 6 on the sample side

1 on the reference side

Note: Cells are not included.

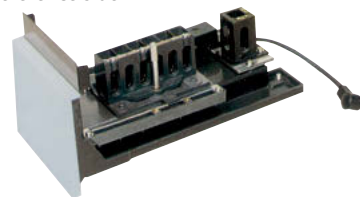

Universal Rectangular Cell Holder, Four-Cell Type (P/N 204-27208)

Holds four rectangular cells with an optical path length of 10, 20, 30, 50, 70, or 100 mm.

Note: The Four-Cell Sample Compartment unit (P/N 206-23670-91) is required. When a rectangular, long-path cell is used on the reference side, its holder (P/N 204-28720) is additionally required.

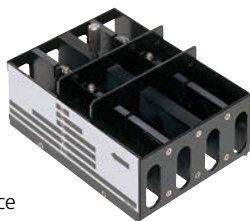

Reference-Side Rectangular Long-Path Absorption Cell Holder (P/N 204-28720)

If using a 4-cell-type universal rectangular cell holder, only use a reference-side cell holder if necessary.

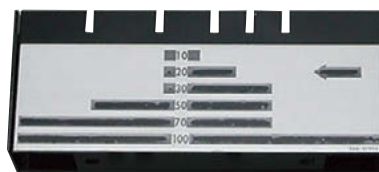

Long-Path Rectangular Cell Holder (P/N 204-23118-01)

Holds two rectangular cells with an optical path length of 10, 20, 30, 50, 70, or 100 mm.



Cylindrical Cell Holder (P/N 204-06216-02)

Holds two cylindrical cells with an optical path length of 10, 20, 50, or 100 mm.



Super Micro Cell Holder (P/N 206-14334)

Holds supermicro cells for measurement of extremely small volume samples. The cell height is adjustable, and the required sample volume can be adjusted in the range of 50 to 200 μL , depending on the type of black cell used.

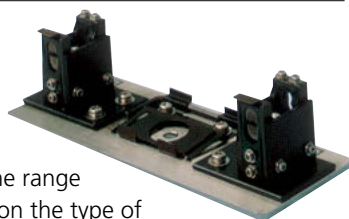

- Applicable cells: ⑦, ⑦', and ⑧ in the list of cells on page 22. Cells are not included.
- Mask: Choice of 1.5 (W) \times 1 (H) mm or 1.5 (W) \times 3 (H) mm

Micro Cell Holder with Mask (P/N 204-06896)

Required when using semi-micro cells or micro cells with an optical path width of 3 mm or less. (The mask width can be adjusted.)



3- μL Capillary Cell Set for Ultramicro Volume Measurement

(P/N 206-69746)

Recommended for small-volume and precious samples, such as in biological applications. Solution sample is aspirated into the capillary cell and the cell is set in the capillary adapter cell, where it is analyzed. The holder is the same size as a 10-mm square cell and can be mounted to the standard cell holder.

- The minimum sample volume required: 3 μL when tube closure is used (theoretical value)
- Supplied with 100 capillaries (made of quartz) and a tube closure
- Inner diameter of capillary: 0.5 mm

Note: Usually, the effective optical path length is approximately one-twentieth of a 10-mm square cell.



8/16-Series Micro Multi-Cell

Cell Holders

Model	P/N
8/16 Series Micro Multi-cell Holder MMC-1600	206-23680-58
8/16 Series Constant-Temperature Micro Multi-cell Holder MMC-1600C	206-23690-91

This cell holder holds one micro multi-cell, either 8 or 16 cell, for micro-volume measurement. Two types of micro multi-cell holders are available: the standard type (MMC-1600) and the constant-temperature water circulation type (MMC-1600C).

- Applicable temperature range: 10°C to 60°C (C type)
- Temperature deviation between circular water and cell: max. 3 °C (C type)
- Temperature stabilizing time: 15 min or less (C type)

Micro Multi-Cells

Model	P/N
8-series Micro Multi-cell; optical path length: 10 mm; cell volume: 100 μL	208-92089
16-series Micro Multi-cell; optical path length: 10 mm; cell volume: 100 μL	208-92088
8-series Micro Multi-cell; optical path length: 5 mm; cell volume: 50 μL	208-92086
16-series Micro Multi-cell; optical path length: 5 mm; cell volume: 50 μL	208-92085

There are two types of micro multi-cells available in both the 8-series and 16-series models: a 50 μL type and a 100 μL type. The cell intervals of the 8-series micro multi-cells are applicable for use with 8x12-well microplates and 8-channel pipettes. Microplate samples aspirated into multi-channel pipettes can be injected directly into the cells for measurement.

- Micro-volume samples can be measured. (Minimum sample volume: 50 μL to 100 μL)
- Support for commercial microplates and micro pipettes (with 8-series micro cells).
- Up to 16 samples can be measured at a time (with 16-series micro cell).

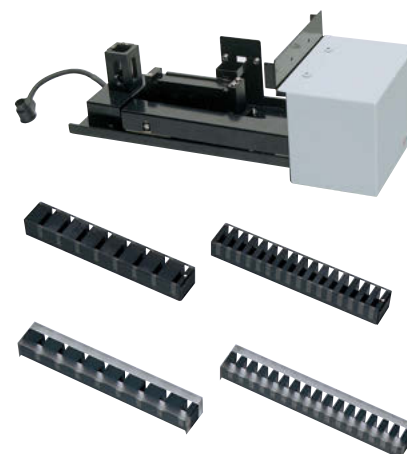

Accessories

Constant-Temperature Cell Holder (P/N 202-30858-04)

Maintains a sample cell and reference cell at a desired, uniform temperature, by circulating constant-temperature water.

- Temperature range: 5°C to 90°C
(depends on the performance of the constant-temperature water circulator)
- Cell holder: Accepts a pair of 10-mm square cells.
- Connecting joint outer diameter: 6 mm and 9 mm (two levels)

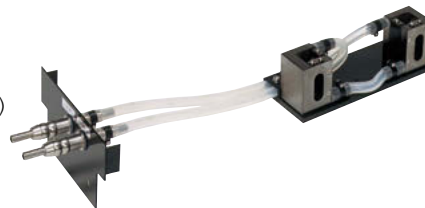

Constant-Temperature Four-Cell Holder (P/N 204-27206-02)

Maintains four sample cells and a reference cell at a desired, uniform temperature, by circulating constant-temperature water.

- Temperature range: 5°C to 90°C
(depends on the performance of the constant-temperature water circulator)
- Cell holder: Accepts four 10-mm square cells plus a reference cell
- Connecting joint outer diameter: 9 mm

Note: The Four-Cell Sample Compartment Unit (P/N 206-23670-91) is necessary.



CPS-100 Cell Positioner, Thermoelectrically Temperature Controlled (P/N 206-29500-**)

This attachment permits measurement of up to six sample cells under constant-temperature conditions. Combination of this attachment and the Kinetics mode provides measurement of temperature-sensitive enzyme kinetics of one to six samples.

- Number of cells: 6 on the sample side (temperature-controlled)
1 on the reference side (temperature not controlled)
- Temperature control range: 16°C to 60°C
- Temperature display accuracy (difference from the true value): $\pm 0.5^\circ\text{C}$
- Temperature control precision (variation of temperature): $\pm 0.1^\circ\text{C}$
- Ambient temperature: 15°C to 35°C

Note: Square cells (P/N 200-34442) are not included, please purchase separately.
A USB adapter CPS (P/N 206-25234-91) is required.



TCC-100 Thermoelectrically Temperature Controlled Cell Holder (P/N 206-29510-**)

Uses Peltier effect for controlling the sample and reference temperature, so no thermostated bath or cooling water is required.

- Number of cells: One each on the sample and reference sides (temperature-controlled)
- Temperature control range: 7°C to 60°C
- Temperature display accuracy (difference from the true value): $\pm 0.5^\circ\text{C}$
- Temperature control precision (variation of temperature): $\pm 0.1^\circ\text{C}$

Note: Square cells (P/N 200-34442) are not included, please purchase separately.



S-1700 Thermoelectric Single-Cell Holder (P/N 206-23900-**) ---

This cell holder permits setting of a temperature program to increase and decrease the sample cell temperature.

- The thermoelectric system allows prompt control of sample temperature between 0°C and 110°C.
- Temperature increase/decrease speed can be changed using 12 settings, which means the holder can be used in analysis of melting curves for nucleic acids, etc., that occur during quick as well as slow heating (or cooling).
- A stirrer is also provided to ensure uniform temperature distribution throughout the cell. Cooling water circulation is required for Peltier element cooling. And though tap water can be used, it is recommended that a commercially available constant-temperature water circulator be used, as the following conditions must be fulfilled to exact maximum performance from the S-1700.

Cooling water specification: 20 ± 2°C

Water flow: 4.8 L/min min or more.

- Temperature is not controlled at the reference side.

Type	Optical Path Length	Minimum Sample Volume Required
110-QS-10	10 mm	3.5 mL
115B-QS-10	10 mm	400 µL

- Cells are not supplied. Please use 10-mm square tight-sealing cells (a Hellma product).

- Temperature accuracy in cell (when room temperature is 25°C):
 Within 0.25°C (0°C to 25°C)
 Within ± 1% of set value (25°C to 75°C)
 Within ± 2% of set value (75°C to 110°C)



Tm Analysis System TMSPC-8 (P/N 206-24350-91) ---

This system obtains a temperature-versus-absorbance curve data, and the Tm Analysis Software analyzes the Tm (melting temperature) of nucleic acids such as DNA and RNA. The system consists of an 8 Series Micro Multi-Cell Holder, Tm Analysis Software, and Temperature Controller. 8 Series Micro Cells, Silicone Cap, and Constant-Temperature Water Circulator for protecting peltier device are not included. Please purchase separately.

Description	P/N
8 Series Micro Cell Optical Path 10 mm, Sample Volume 100 µL	208-92097-11
8 Series Micro Cell Optical Path 1 mm, Sample Volume 35 µL	208-92140
Silicone Cap for Micro Cell (24 pcs)	206-57299-91

- Temperature control range: 0.0 to 10.0°C
- Tm Calculation mode: Average Method, Differential Method
- OS: Windows 7 Professional

Note: Please purchase the constant-water circulator which fulfills specifications below.
 Temperature range: 20 ± 2°C, Flow rate: 4.8 L/min or more
 Inner diameter of the connecting pipe: ø8, 10, 12 mm



NTT-2200P Constant-Temperature Water Circulator (P/N 208-97263) ---

Circulates temperature-controlled water to a constant-temperature cell holder.

- Temperature range: Ambient +15°C to 80°C
- Temperature control precision: ± 0.05°C or more
- Maximum pumping rate: 27/31 L/min, 9.5/13 m (50/60 Hz)
- External circulation nozzle: 10.5 mm OD (both outlet and return)
- Tank capacity: About 10 L (9 L during use)
- Safety features: Detection of over-temperature of Upper or Lower limits, Detection of heater wire malfunction, Protection from heating too little circulating water, Detection of sensor malfunction, Independent over-heat protection, Over-current circuit protector
- Standard accessories: Lid with handles, Rubber hose (4 m; inner diameter: 8 mm; outer diameter: 12 mm; quantity: 1), Hose clamps (4pc), instruction manual (Japanese and English)
- Dimensions: 270 (W) × 560 (H) × 400 (D) mm
- Power requirements: 100 VAC, 1,250 VA, with 1.7-m power cord and grounded plug



UV-1800
UV-VIS Spectrophotometer

Accessories

Model	P/N	Standard Sample Volume
Sipper Unit 160L (Standard Sipper)	206-23790-51	2.0 mL
Sipper Unit 160T (Triple-Pass Sipper)	206-23790-52	1.5 mL
Sipper Unit 160C (Constant-Temperature Sipper)	206-23790-53	2.5 mL
Sipper Unit 160U (Supermicro Sipper)	206-23790-54	0.5 mL

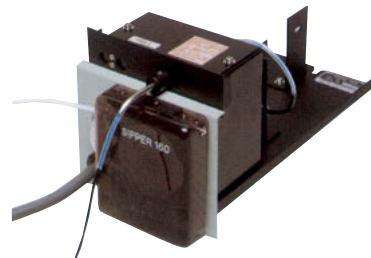

Four types of sipper units with different flow cell types are available. The stepping motor-driven peristaltic pump ensures reliable and smooth aspiration of sample solution.

(Direct driving is possible from the UV-1800 so no interface is required.)

Note: The use of a Solenoid Valve (Fluoropolymer) (P/N 204-06599-01) and the SWA-2 Sample Waste Unit (206-23820-58) are recommended when strong acids, strong alkalis, or organic solvents are to be measured.

Syringe Sipper

Model	P/N
Syringe Sipper N (Normal temperature type)	206-23890-51
Syringe Sipper CN (Constant temperature, water circulator type)	206-23890-52

The sipper unit employs a syringe-pump system. The liquid-contact surfaces are composed of Fluoropolymer, glass, or quartz, imparting excellent chemical resistance and ease of maintenance, and allowing measurement of almost any sample type. Further, the extremely high repeatability of sipping volume (repeat precision: ± 0.03 mL) makes it ideal when performance validation is required.

Note: Flow cell available separately. Choose from the recommended flow cells listed below.

Recommended Flow Cells				
Cell Type	P/N	Optical Path Length	Dimensions of Aperture	Standard Required Sample Volume
Square (ultra-micro)	208-92114	10 mm	$\phi 2$ mm	0.9 mL
Square (micro)	208-92113	10 mm	$\phi 3$ mm	1.0 mL
Square (semi-micro)	208-92005	10 mm	11 (H) \times 3.5 (W) mm	5.0 mL

- The type of flow cell can be selected in accordance with the application.
- The flow cell can be changed independently for excellent ease of maintenance.
- Circulated-water temperature range: ambient to 60°C (CN type)

Note: If a square flow cell (micro or supermicro) is used, attaching mask R (206-88679) to the reference cell holder is recommended to balance the light intensity.



ASC-5 Auto Sample Changer (P/N 206-23810-**)

Combine with a Sipper 160 to build an automated multisample spectrophotometry system.

- The aspirating nozzle is programmed to move in the X, Y, and Z (vertical) directions.
- Up to 8 sets of operational parameters, including the sizes of racks and the numbers of test tubes, may be memorized in the battery back-up protected files.
- Up to 100 test tubes may be set together on the rack.

Note: An ASC USB adapter (P/N 206-25235-91) is required.

Note: A commercially available test tube stand, with a footprint smaller than 220 \times 220 mm, is applicable.



Micro Flow Cell

Used for the continuous analysis of samples such as the liquids produced by column chromatography.

Model	P/N	Optical Path Length	Volume
10-mm Micro Flow-thru Cell with Holder	204-06222-40	10 mm	0.3 mL
5-mm Micro Flow-thru Cell with Holder	204-06222-41	5 mm	0.15 mL

- Inner diameter of tube: 1 or 2 mm

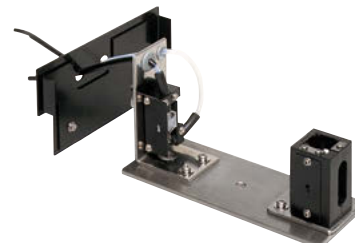

Front Panel with Holes (P/N 204-27588-03)

Allows the tubes of a flow cell, for example, to be connected through the front panel of the instrument.



Flow-Thru Cell for HPLC (P/N 206-12852-41)

With this flow-thru cell attached, the spectrophotometer can be used as a variable-wavelength UV-VIS detector for an HPLC system.

- Inner diameter: 1 mm; Optical path length: 10 mm; Inner volume: 8 μ L
- Flow-thru cell on the sample side and cell holder with a mask on the reference side.
- SUS tube: Outer diameter: 1.6 mm; Inner diameter: 0.3 mm

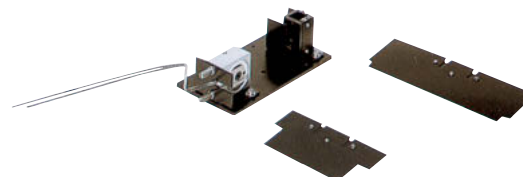

Specular Reflectance Measurement Attachment (5° Incident Angle) (P/N 206-14046)

The technique of specular reflectance measurement is often applied to the examination of semiconductors, optical materials, multiple layers, etc., relative to a reference reflecting surface. The 5° incident angle minimizes the influence of polarized light. Thus, no polarizer is required in measurement ... the operation is quite simple.

- Samples as large as 100 (W) \times 160 (D) \times 15 (T) mm can be readily measured. The minimum size is 7 mm in diameter.
- Sample placement is easy - just set it on a holder with the measuring surface down.

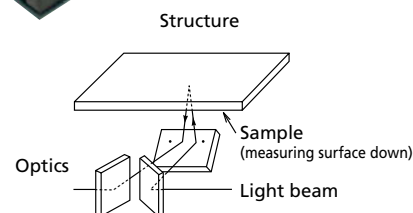

Accessories

MPU Screen Copy Printer (P/N 206-26007-**) ---

Prints hard copies of screens, including numeric data. Numerical data is printed after each measurement. Spectra, kinetic reaction data, and quantitation calibration curves displayed on the screen are output in the screen print. A hard copy can be printed at any time, making it simple to record measurement parameters.

- Thermal paper (10 rolls; P/N 088-58907-04)

Note: A USB cable is required for connection to the UV-1800.



Analog Output Interface (P/N 206-25233-91) ---

- Allows analog output for monitoring a liquid chromatograph, etc., and can connect to an integrator.
- Analog output full scale: 100 mV / 2 Abs or 100 mV / 100%T



USB Interface Cable (P/N 088-52848-32) ---

- Used to connect to the UV-1800 main unit and a PC.

Cells

Description	Optical Path (L)	Required Sample Volume	Type	Fused Silica (S)	Glass (G)
Square cell	10 mm	2.5 to 4.0 mL	①	200-34442	200-34565
	20 mm	5.0 to 8.0 mL		200-34446	200-34446-01
	50 mm	12.5 to 20.0 mL	⑥	200-34944	200-34944-01
	100 mm	25.0 to 40.0 mL		200-34676	200-34676-01
Square cell with stopper	10 mm	2.5 to 4.0 mL	②	200-34444	200-34444-01
Semi-micro cell	10 mm	1.0 to 1.6 mL	③ ^{*1}	200-66501	200-66501-01
Semi-micro black cell	10 mm	1.0 to 1.6 mL	③ ^{*1}	200-66551	—
Supermicro black cell	5 mm	25 to 100 µL	⑦ ^{*2}	208-92116	—
	10 mm	50 to 200 µL	⑦ ^{*2}	200-66578-11	—
Micro black cell	10 mm	50 to 400 µL	⑧ ^{*2}	200-66578-12	—
Cylindrical cell	10 mm	3.8 mL	④	200-34448 (silica window)	200-34448-01 (glass window)
	20 mm	7.6 mL		200-34472 (")	200-34472-01 (")
	50 mm	19.0 mL		200-34473-01 (")	200-34473-03 (")
	100 mm	38.0 mL		200-34473-02 (")	200-34473-04 (")
Short path cell	1 mm	0.3 to 0.4 mL	⑤	200-34660-01	200-34662-01
	2 mm	0.5 to 0.8 mL		200-34655	200-34662-11
	5 mm	1.3 to 2.0 mL		200-34449	200-34449-01

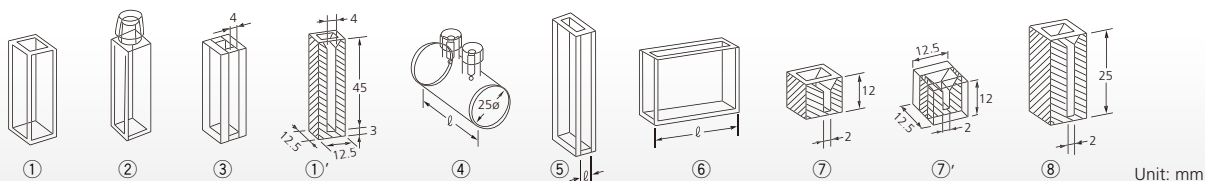

Note: *1 With a 5 mm slit, the cell holder with micro cell mask (204-06896) is required.
 *2 The supermicro cell holder (206-14334) is required.

Optional Software (MS-Windows only)

Optional software that can be used when controlling operation from a PC

LabSolutions Connection Kits

LabSolutions DB Connection Kit (P/N 207-21250-91)

LabSolutions CS Connection Kit (P/N 207-21251-91)

This software is used to perform operations such as automatically registering data obtained and processed using UVProbe and PDF report files in a LabSolutions database, securely managing data, or applying electronic signatures. Consequently, this kit allows for making UVProbe compliant with FDA 21 CFR Part 11. It also provides network capability, which allows you to use the network server to centrally manage data from other analytical instruments, such as HPLC, GC, or FTIR systems, by installing software that is compatible with such equipment. It even allows you to view the data from a client computer on the network.

Access Control and User Management

As with UVProbe, user access to the program is centrally managed by a user-authentication server without depending on the operating system, enabling a level of access control that complies with FDA 21 CFR Part 11. It is also possible to restrict the functions that can be executed by authenticated users on an individual basis, eliminating the possibility of unauthorized users making erroneous changes to settings.

Security and Audit Trails

All saved electronic records are stored and managed in a database, ensuring the original data is not lost when records are changed. Also, the contents of system usage records and records of changes made to data registered in the database are recorded together with the date and the name of the person concerned.

Data Integrity and Electronic Signatures

Data is automatically stored in the database and is not deleted. The data stored in the database can be easily restored, allowing it to be displayed or reanalyzed as necessary. Also, electronic signatures can be applied to electronically recorded data which is linked to analytical data, and the name of the signer, the date of the signature, and the reason for the signature are saved.

Manage Related Information for Each Project

LabSolutions includes a project management function that allows information to be managed based on the type of process or system used. This function allows you to specify different instrument management, user management, security policy, and data processing settings for each project, which helps ensure searching data and other management processes can be performed smoothly.

- Applicable Operating System: Windows 7 Professional

UVProbe Agent Software (P/N 206-21550-92)

The UVProbe Agent, which was developed for Shimadzu UV-VIS spectrophotometers, is used to automatically transfer and store the various types of data acquired, or the results of performing data processing with the UVProbe software, to a general-purpose database, and to perform operations related to high-security data management and electronic signatures. This makes it possible for UVProbe to attain compliance with FDA 21 CFR Part 11.

The UVProbe Agent is network-compatible; therefore, by installing other Agent software for corresponding analytical instruments, such as HPLC or FTIR spectrophotometers, data from all analytical instruments can be integrally managed at a server PC and that data can be browsed at client PCs.

Tm Analysis Software (P/N 206-57476-91)

This software works with the S-1700 and accumulates temperature-versus-absorbance curve data at the PC to analyze the Tm (melting temperature) of nucleic acids such as DNA and RNA. The right figure is a typical setup for this software.

- Applicable OS : Windows 7 Professional

Note: An RS-232C cable (P/N 200-86408) is needed to connect the PC to the S-1700.

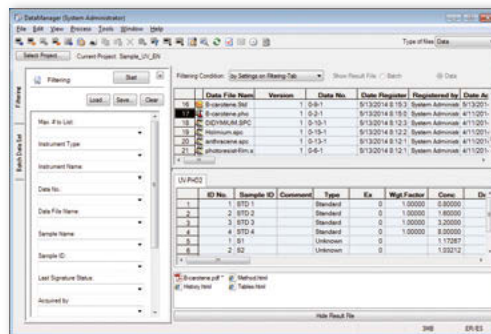

LabSolutions Data Manager

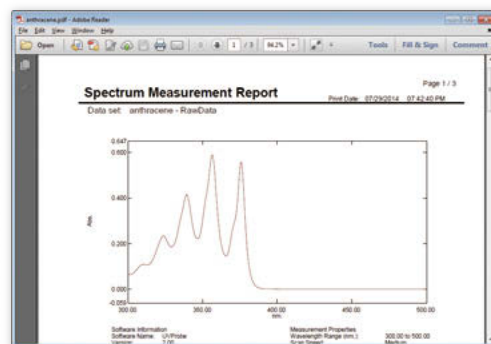

PDF Report of Data

The screenshot shows the CLASS-Agent Manager interface with a table listing instrument data. The table has columns for 'Reg date', 'PC name', 'Instrument name', 'Data process type', and 'Sample name'. The data rows include details for various instruments like 'UV-2000' and 'UV-2001'.

CLASS-Agent Manager

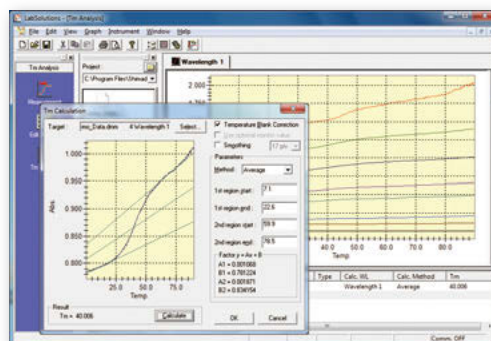

Accessories

UV-1800 Specifications

Item	Specification
Wavelength range	190 to 1,100 nm
Spectral bandwidth	1 nm (190 to 1,100 nm)
Wavelength display	0.1 nm increments
Wavelength setting	0.1 nm increments (1 nm increments when setting scanning range)
Wavelength accuracy	± 0.1 nm at D2 peak 656.1 nm, ± 0.3 nm for entire range
Wavelength repeatability	± 0.1 nm
Wavelength slew rate	About 6,000 nm/min
Wavelength scanning speed	3,000 to 2 nm/min
Lamp interchange wavelength	Automatic interchange linked to wavelength. The interchange wavelength can be set freely in the range of 295 to 364 nm (0.1 nm increments).
Stray light	Less than 0.02% at 220 nm (NaI) Less than 0.02% at 340 nm (NaNO ₂) Less than 1.0% at 198 nm (KCl)
Photometric system	Double beam optics
Photometric range	Absorbance: -4 to 4 Abs Transmittance: 0% to 400%
Photometric accuracy	± 0.002 Abs at 0.5 Abs ± 0.004 Abs at 1.0 Abs ± 0.006 Abs at 2.0 Abs (measured using NIST930D/NIST1930 or equivalent.)
Photometric repeatability	Less than ± 0.001 Abs at 0.5 Abs Less than ± 0.001 Abs at 1 Abs Less than ± 0.003 Abs at 2 Abs

Item	Specification
Baseline stability	Less than 0.0003 Abs/Hr (700 nm, one hour after light source turned ON)
Baseline flatness	Less than ± 0.0006 Abs (1,100 to 190 nm, one hour after light source turned ON)
Noise level	Less than 0.00005 Abs (700 nm)
Light source	20-W halogen lamp and deuterium lamp Built-in light source auto position adjustment
Monochromator	Blazed holographic grating in Czerny-Turner mounting
Detector	Silicon photodiode
Sample compartment	Internal dimensions: 110 (W) × 250 (D) × 115 (H) mm Distance between light beams: 100 mm
Power requirements	AC100,120,220,230,240 V, 50/60 Hz, 140 VA
Environmental requirements	Temperature: 15°C to 35°C Humidity: 30% to 80% (without condensation; 70% max. at 30°C or higher)
Dimensions	450 (W) × 490 (D) × 270 (H) mm
Weight	15 kg
Output device	USB memory (optional) Data files saved in text format or UVPC format. UVPC-format files can be read directly by UVProbe.
PC compatibility	Provided with UVProbe software. External control possible via USB.

UV-1800 Software Specifications

Measurement mode	Specification
Photometric mode	<p>Single-wavelength measurement</p> <ol style="list-style-type: none"> 1. Photometric modes: T% or Abs 2. Quantitation using K-factor method 3. Data table storage and recall functions <p>Multiple-wavelength measurement</p> <ol style="list-style-type: none"> 1. Photometric modes: T% or ABS 2. Measurements at up to eight designated wavelengths (set in 0.1 mm increments) 3. Data calculation at up to four wavelengths (difference or ratio between two wavelengths, calculation between three wavelengths, etc.) is possible.
Spectrum mode	<ol style="list-style-type: none"> 1. Measurement modes: ABS, T%, E 2. Number of repeat scans: 1 to 99 3. Recording system: Selection between single spectrum and data overlay 4. Data storage and recall 5. Data processing: Peak/valley detection, arithmetic operations, differentiation, smoothing, area calculation, point picking, data reading at cursor-specified point
Quantitation mode	<ol style="list-style-type: none"> 1. Measurement methods: 1-wavelength, 2-wavelength, 3-wavelength, and 1st to 4th derivative methods 2. Quantitation methods: Automatic concentration calculation using K-factor Automatic concentration calculation using single-point calibration curve Multi-point calibration curve method (1st to 3rd order regression curves) 3. Measurement parameters: Number of standards (2 to 10) Number of repeat measurements (1 to 10 times) to obtain a mean value for quantitation.
Kinetics mode	<ol style="list-style-type: none"> 1. Measures absorbance changes as a function of time and calculates the enzymatic activity values. 2. Measurement time: 1 to 9,999 sec/min 3. Measurement methods: 1-wavelength, 2-wavelength, multi-cell, and rate measurements
Time scan mode	<ol style="list-style-type: none"> 1. Measures changes in measured values as a function of time. 2. Measurement mode: ABS, T%, E 3. Measurement time: 1 to 9,999 sec/min 4. Data processing functions (same as spectrum mode)
Multi-component quantitation mode	<ol style="list-style-type: none"> 1. Up to eight components quantified at once. 2. A mixture, as well as pure components, can be used as a standard. 3. Data on standards samples can be stored, in addition to measurement wavelengths 4. Quantitation of recalled spectrum data.

Measurement mode	Specification
Biomethod mode	<p>DNA/Protein Quantitation</p> <ol style="list-style-type: none"> 1. Calculation of DNA/protein concentration and absorbance ratio DNA concentration = $K1 \times A1 - K2 \times A2$ Protein concentration = $K3 \times A2 - K4 \times A1$ 2. Factors and measurement wavelengths can be set freely. 3. Background correction is possible. <p>Quantitation of proteins</p> <ol style="list-style-type: none"> 1. Quantitation methods: Lowry method, BCA method, Biuret method, CBB method (Bradford method), UV method
Maintenance	<ol style="list-style-type: none"> 1. Baseline correction 2. Lamp usage time display and reset. 3. Security settings Functions can be restricted according to the user. 4. Instrument validation functions: <ol style="list-style-type: none"> 1) Compatible with 9 JIS items Wavelength accuracy, wavelength repeatability, resolution, stray light, photometric accuracy, photometric repeatability, baseline flatness, baseline stability, noise level. 2) Semi-automatic validation Validation inspections conducted interactively while inserting and removing inspection jigs. 3) Fully automatic validation Automatic validation inspections from measurement to evaluation and printout. 4) Setting inspection parameters and pass/fail criteria Authority to make changes can be protected by password access. 5) Detailed printout of results 6) Bulk printout of results
Shared functions	<ol style="list-style-type: none"> 1. Automatic setting of measurement mode after instrument initialization. It's possible to specify standby and parameter files in the parameter setting window for each measurement mode. 2. Selection of displayed number of decimal places Absorbance: 3 or 4 decimal places Transmittance: 1 or 2 decimal places 3. Number of files that can be saved (built-in memory) Measurement parameters: 24 files max. Data: 8 files max. Tabular data: 8 files max. 4. Setting of integration time (for fixed-wavelength measurement) 5. PC control Spectrophotometer can be controlled by an external PC. This function is also used when performing operation with the UVProbe software provided. *A USB cable is required.

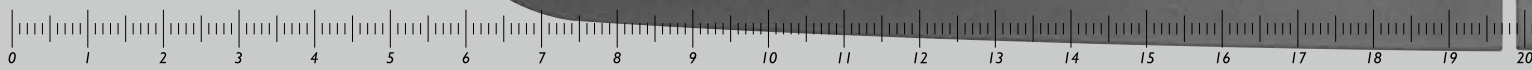

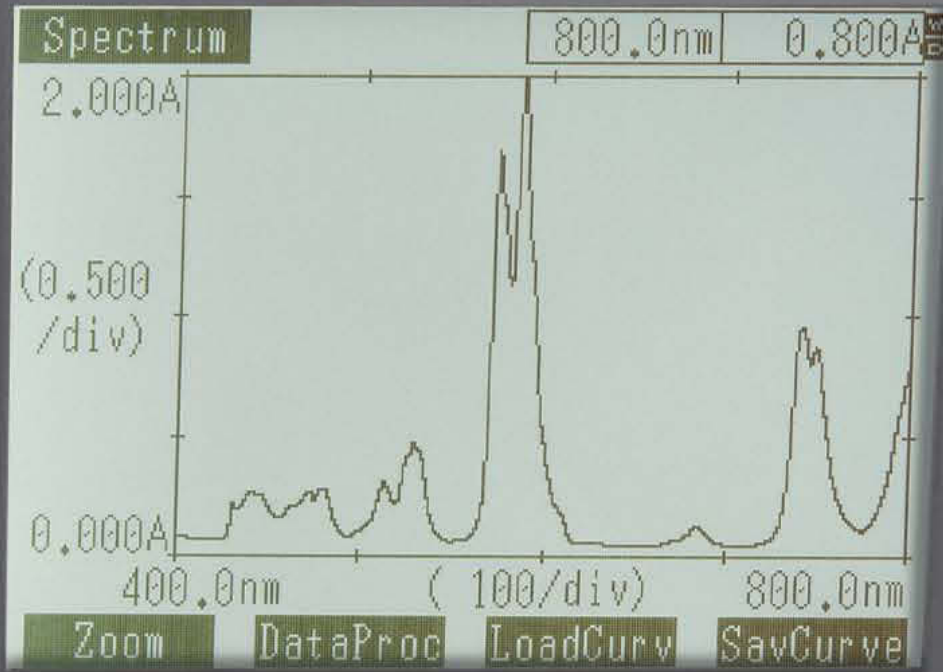

F1

F2

F3

F4

RETURN

7

8

9



LCD
CONT

4

5

6



1

2

3

GOTO
WL

AUTO
ZERO

PRINT

0

.

CE

ENTER

START
STOP



Wolflabs

Wolf Laboratories Limited

www.wolflabs.co.uk

Tel: 01759 301142

Fax: 01759 301143

sales@wolflabs.co.uk



Use the above details to contact us if this literature doesn't answer all your questions.

Pricing on any accessories shown can be found by keying the part number into the search box on our website.

The specifications listed in this brochure are subject to change by the manufacturer and therefore cannot be guaranteed to be correct. If there are aspects of the specification that must be guaranteed, please provide these to our sales team so that details can be confirmed.

