

Scotsman[®]

SERVICE MANUAL

TCL/S 180

**Electronic
counter cubelet
ice dispenser**

**New PC Board
version**

Scotsman Ice Srl
Via Lainate, 31 - 20010 Pogliano M.se - Milano - Italy
Tel. +39-02-93960.1 (Aut. Sel.)- Telefax +39-02-93550500
Direct Line to Service & Parts:
Phone +39-02-93960350 - Fax +39-02-93540449
Website: www.scotsman-ice.it
E-Mail: scotsman.europe@scotsman.it



REV. 07/2016

**TABLE OF
CONTENTS**

Table of contents	page	2
Specifications		3
 GENERAL INFORMATION AND INSTALLATION		
Introduction		5
Unpacking and Inspection		5
Location and levelling		5
Electrical connections		5
Water supply and drain connections		6
Final check list		6
 OPERATING INSTRUCTIONS		
Start up		7
Operational checks		7
 PRINCIPLE OF OPERATION (How it works)		
Water circuit		10
Refrigerant circuit		10
Mechanical system		11
Operating pressures		12
Components description		13
 ADJUSTMENT, REMOVAL AND REPLACEMENT PROCEDURES		
Wiring diagram - Dispensing board version		17
Wiring diagram - Push buttons version		18
Service diagnosis		19
 MAINTENANCE AND CLEANING INSTRUCTIONS		
General		21
Icemaker		21
Cleaning instructions of water system		21

SPECIFICATIONS

ELECTRONIC COUNTER CUBELET DISPENSER TC 180



Important operating requirements:

	MIN	MAX
- Air temperature	10°C (50°F)	40°C (100°F)
- Water temperature	5°C (40°F)	35°C (100°F)
- Water pressure	1 bar (14 psi)	5 bars (70 psi)
- Electr. voltage variations from voltage rating specified on nameplate	-10%	+10%

ice making capacity

AIR COOLED MODELS

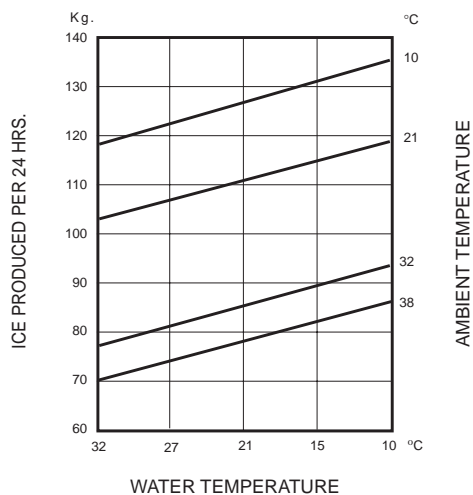

NOTE. The daily ice-making capacity is directly related to the condenser air inlet temperature, water temperature and age of the machine.
 To keep your **SCOTSMAN CUBELET DISPENSER** at peak performance levels, periodic maintenance checks must be carried out as indicated on page 21 of this manual.

SPECIFICATIONS

FRONT VIEW

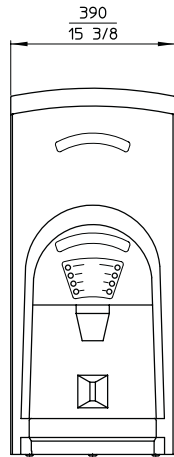

SIDE VIEW

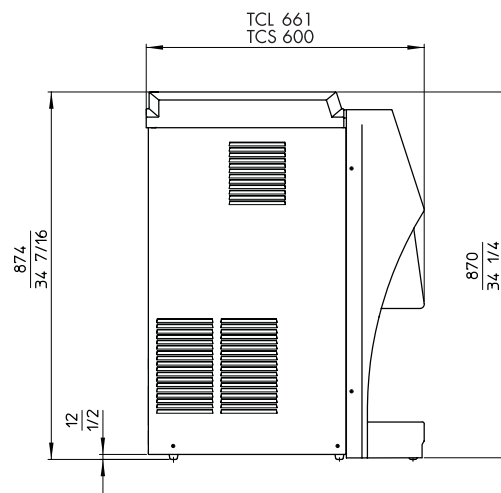

REAR VIEW

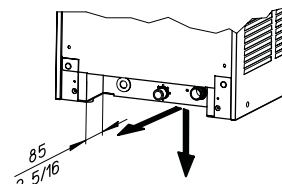
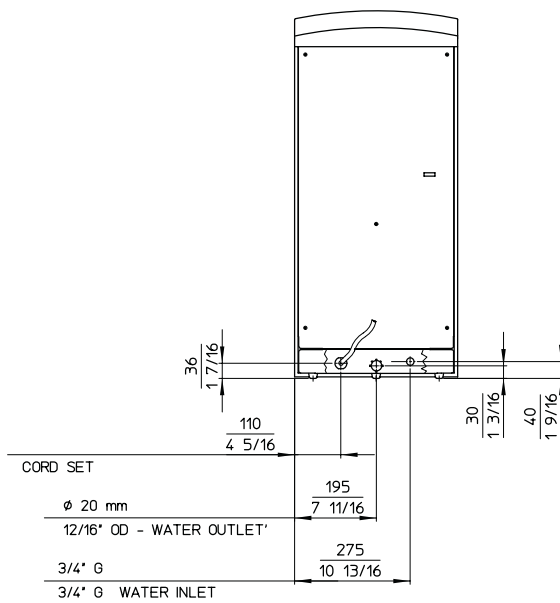

INLET AND DISCHARGE WATER CONNECTIONS OPENING.

TCL/S 180 - MACHINE SPECIFICATIONS

Model	Cond. unit	Finish	Comp. HP	Ice bin cap	Water req. lt/24 HR	
TCS 180 AS TCL 180 AS	Air	S. Steel	3/8	5 Kg. 9 Kg.	135	
Basic electr.	Amps	Start Amps	Watts	Electric power cons. Kwh per 24 HR	Nr. of wires	Amps fuse
230/50/1	3.4	18	590	13,2	3 x 1.5 mm ²	10

GENERAL INFORMATION AND INSTALLATION

A. INTRODUCTION

This manual provides the specifications and the step-by-step procedures for the installation, start-up and operation, maintenance and cleaning for the **SCOTSMAN TCL/S 180** counter cubelet ice dispenser.

Their ice making systems are thoroughly tested providing the utmost in flexibility to fit the needs of a particular user.

NOTE. *To retain the safety and performance built into this icemaker, it is important that installation and maintenance be conducted in the manner outlined in this manual.*

B. UNPACKING AND INSPECTION

1. Call your authorized SCOTSMAN Distributor or Dealer for proper installation.
2. Visually inspect the exterior of the packing and skid. Any severe damage noted should be reported to the delivering carrier and a concealed damage claim form filled in subject to inspection of the contents with the carrier's representative present.
3.
 - a) Cut and remove the plastic strip securing the carton box to the skid.
 - b) Cut open the top of the carton and remove the polystyrene protection sheet.
 - c) Pull out the polystyrene posts from the corners and then remove the carton.
4. Remove the top and sides panels of the unit and inspect for any concealed damage. Notify carrier of your claim for the concealed damage as stated in step 2 above.
5. Remove all internal support packing and masking tape.
6. Check that refrigerant lines do not rub against or touch other lines or surfaces, and that the fan blades move freely.
7. Check that the compressor fits snugly onto all its mounting pads.
8. Use clean damp cloth to wipe the surfaces outside of the cabinet.
9. See data plate on the rear side of the unit and check that local main voltage corresponds with the voltage specified on it.

CAUTION. *Incorrect voltage supplied to the icemaker will void your parts replacement program.*

10. Remove the manufacturer's registration card from the inside of the User Manual and fill-in all parts including: Model and Serial Number taken from the data plate.

Forward the completed self-addressed registration card to SCOTSMAN EUROPE factory.

C. LOCATION AND LEVELLING

WARNING. *This Ice Dispenser is designed for indoor installation only. Extended periods of operation at temperature exceeding the following limitations will constitute misuse under the terms of the SCOTSMAN Manufacturer's Limited Warranty resulting in LOSS of warranty coverage.*

1. Position the unit in the selected permanent location.

Criteria for selection of location include:

	Min	Max
Air Temperature	10°C	40°C
Water Temperature	5°C	35°C
Water pressure	1 bar	5 bar
Voltage	-10%	+10%

(Compared to the nameplate)

Service access: adequate space must be left for all service connections through the rear of the ice maker.

This machine is air cooled and sucks air through the left side panel and blows air out the rear side of the top panel. Do not install the machine where the left side air flow might be blocked. A minimum clearance of 15 cm is required.

It is important that the machine be installed in a location where it has enough space around it to be accessible for service, and minimum of 150 mm be allowed at the left and upper side for air circulation. Try to avoid hot, dirty and crowded locations.

NOTE. *It is imperative to do not place on top of the machine any sort of goods and leave the upper lowers open for proper air exhaust.*

D. ELECTRICAL CONNECTIONS

See data plate for current requirements to determine wire size to be used for electrical connections. All SCOTSMAN icemakers require a solid earth wire.

All SCOTSMAN ice machines are supplied from the factory completely pre-wired and require only electrical power connections to the wire cord provided at the rear of the unit.

Make sure that the ice machine is connected to its own circuit and individually fused (see data plate for fuse size).

The maximum allowable voltage variation should not exceed -10% and +10% of the data plate rating. Low voltage can cause faulty functioning and may be responsible for serious damage to the overload switch and motor windings.

NOTE. All external wiring should conform to national, state and local standards and regulations.

Check voltage on the line and the ice maker's data plate before connecting the unit.

E. WATER SUPPLY AND DRAIN CONNECTIONS

GENERAL

When choosing the water supply for the ice flaker consideration should be given to:

- a) Length of run
- b) Water clarity and purity
- c) Adequate water supply pressure

Since water is the most important single ingredient in producing ice you cannot emphasize too much the three items listed above.

Low water pressure, below 1 bar may cause malfunction of the ice maker unit.

Water containing excessive minerals will tend to produce scale build-up on the interior parts of the water system while too soft water (with too low contents of mineral salts), will produce a very hard flaker ice.

PLUMBING CONNECTIONS MUST CONFORM TO ALL APPLICABLE CODES

CONNECT TO POTABLE WATER ONLY

The model TCL/S 180 has the possibility to have the water connections through the bottom base or through the rear bottom side of the machine. In this second case it is necessary to remove the rear bottom small panel.

WATER SUPPLY

Connect the 3/4" GAS male of the water inlet fitting, using the flexible tube supplied to the cold water supply line with regular plumbing fitting and a shut-off valve installed in an accessible position between the water supply line and the unit.

If water contains a high level of impurities, it is advisable to consider the installation of an appropriate water filter or conditioner.

WATER DRAIN

The recommended drain tube is a plastic or flexible tube with 18 mm (3/4") I.D. which runs to an open trapped and vented drain. When the drain is a long run, allow 3 cm pitch per meter (1/4" pitch per foot).

Install a vertical open vent on drain line high point at the unit drain connection to ensure good draining.

The ideal drain receptacle is a trapped and vented floor drain.

NOTE. The water supply and the water drain must be installed to conform with the local code. In some case a licensed plumber and/or a plumbing permit is required.

F. FINAL CHECK LIST

1. Is the unit in a room where ambient temperatures are within a minimum of 10°C (50°F) even in winter months?
2. Is there at least a 15 cm (6") clearance around the unit for proper air circulation?
3. Is the unit level?
4. Have all the electrical and plumbing connections been made, and is the water supply shut-off valve open?
5. Has the voltage been tested and checked against the data plate rating?
6. Has the water supply pressure been checked to ensure a water pressure of at least 1 bar (14 psi).
7. Check all refrigerant lines and conduit lines to guard against vibrations and possible failure.
8. Has the owner/user been given the User Manual and been instructed on the importance of periodic maintenance checks?
9. Has the Manufacturer's registration card been filled in properly? Check for correct model and serial number against the serial plate and mail the registration card to the factory.
10. Has the owner been given the name and the phone number of the authorized SCOTSMAN Service Agency serving him?

OPERATING INSTRUCTIONS

START UP

After having correctly installed the ice maker and completed the plumbing and electrical connections, perform the following "Start-up" procedure.

A. Open the water supply line shutoff valve and give power by moving the main switch, on the power supply line, to the ON position. The **GREEN LED** will glow to signal that unit is under power.

NOTE. Every time the unit is put under power, after being kept for sometime in shut-off conditions (electrically disconnected) the 2nd RED LED will blink for 3 minutes (Fig.1).

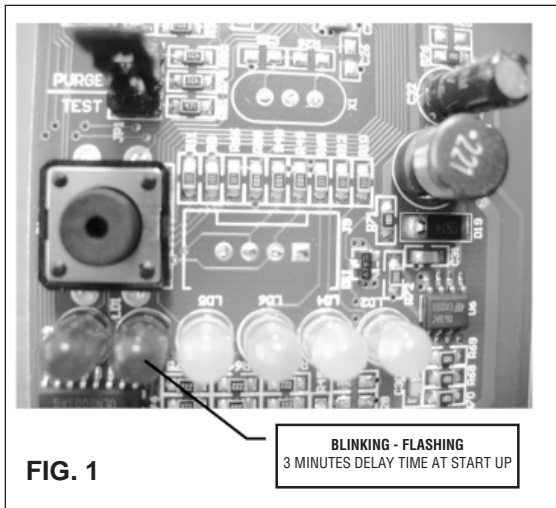

B. Elapsed the 3 minutes - stand by period - the unit starts operating with the activation in sequence of the following assemblies:

GEAR MOTOR

COMPRESSOR

FAN MOTOR kept under control by the condenser temperature sensor which has its probe within the condenser fins with the switching off of the 2nd RED LED (Fig. 2).

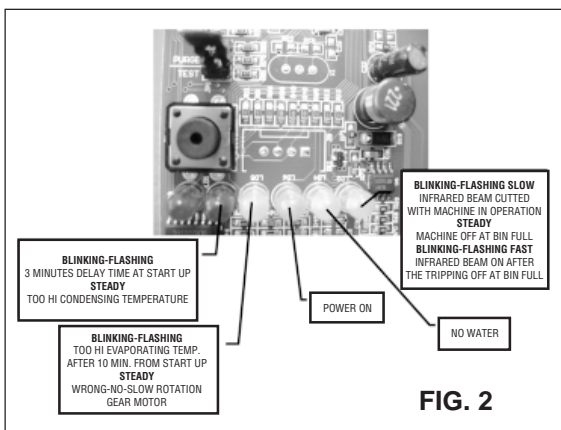

C. 2 or 3 minutes after the compressor start up, observe that flaker ice begins dropping off the ice spout to fall into the storage bin.

NOTE. If, after ten minutes from the compressor start-up, the evaporating temperature has not dropped down to a value lower than -1°C (30°F) the evaporating temperature sensor detects such an abnormal situation and stops consequently the unit operation. In this circumstance, the 3rd warning **YELLOW LED** will blink (Fig.3). After having diagnosed and eliminated the cause of the poor evaporating temperature (insufficient refrigerant in the system or inoperative compressor or evaporator sensor) it is necessary to push the **RE-SET BUTTON**. The unit, before resuming the total operation, will go through the usual 3 minutes **STANDBY** period.

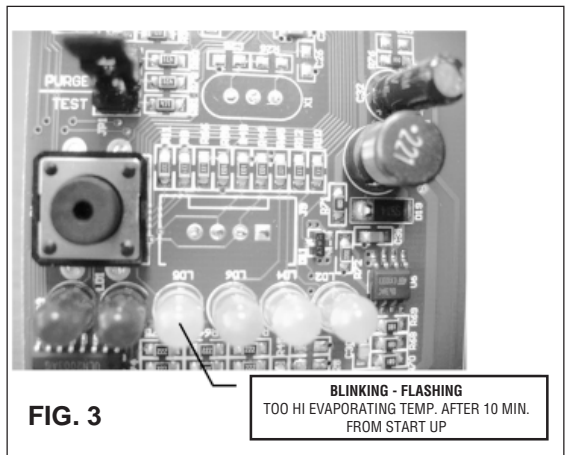

OPERATION CHECKS UPON THE UNIT START UP

D. Remove service panels and if necessary install the refrigerant service gauges on the corresponding Service valves to check both the HI and LO refrigerant pressures.

NOTE. The condenser temperature sensor, which is located within the condenser fins, keeps the head (condensing) pressure between two preset valves. In case of condenser clogging such to prevent the proper flow of the cooling air or, in case the fan motor is out of operation, the condenser temperature rises and when it reaches 70°C (160°F) the condenser temperature sensor shuts-off the ice maker with the consequent light-up of the 2nd **RED WARNING LIGHT** (Fig.4). After having diagnosed the reason of the temperature rise and removed its cause, it is necessary to proceed as per the previous "NOTE" to start up again the operation of the ice maker.

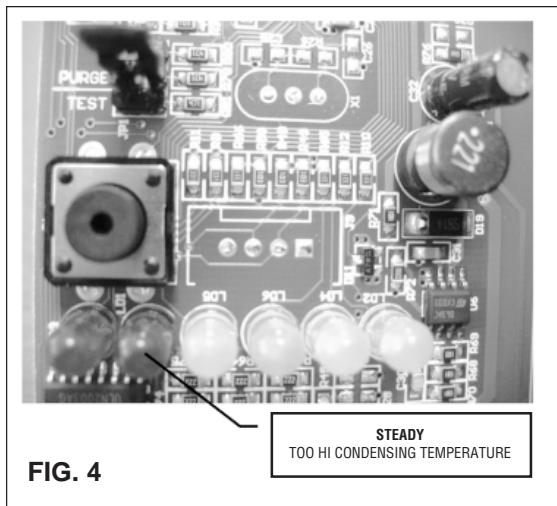

E. Check for the correct CUT-OUT and CUT-IN of the **float reservoir water level sensors** by shutoff the valve on the water supply line.

This will cause a gradual decrease of the water level in the float reservoir and as soon as the level gets below the sensors, the flaker stops to operate and the **5th YELLOW warning LED** will glow to signal the shortage of water (Fig.5).

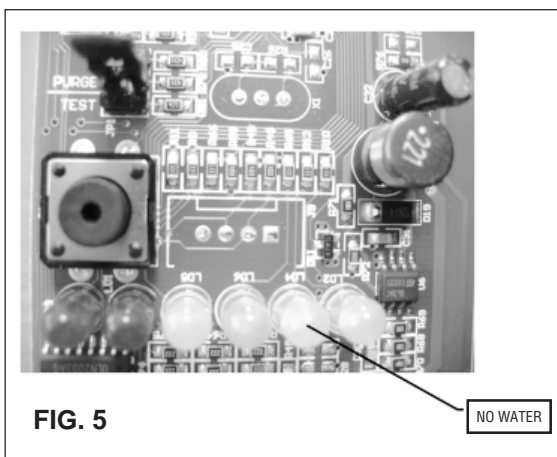

NOTE. The water level sensor detects the presence of sufficient water in the float reservoir and confirms it to the micro processor by maintaining a low voltage current flow between the two sensors using the water as conductor.

WARNING. The use of de-mineralized water (water with no salt content) having an electrical conductivity lower than 30 μ S, will cause the ability of the water sensors to vanish with the consequent CUT-OUT of the flaker operations and the glowing of the YELLOW LED of shortage of water, even though that water is indeed in the reservoir.

After this, open the water supply line shutoff valve to fill up again the float reservoir, the **5th YELLOW LED** goes off while the **2nd RED LED** starts blinking.

After 3 minutes the unit resumes its total operation with the immediate start-up of the gear motor and, 2 seconds later, of the compressor.

F. Check for the correct operation of the electronic eye for the ice bin level control, by placing one hand between the sensing “eyes” located in the ice spout, to interrupt the light beam.

This interruption will cause an immediate blink of the **1st YELLOW LED** and after about 6 seconds causes the shutoff of the unit with the simultaneous lighting of the **same YELLOW LED** signalling the **full bin situation** (Fig.6).

Allow the resumption of the light beam previously interrupted and after about 6 seconds with YELLOW LED blinking fast, the flaker will resume - through the 3 minutes STAND-BY period - the ice making process with the extinguishing of the YELLOW LED.

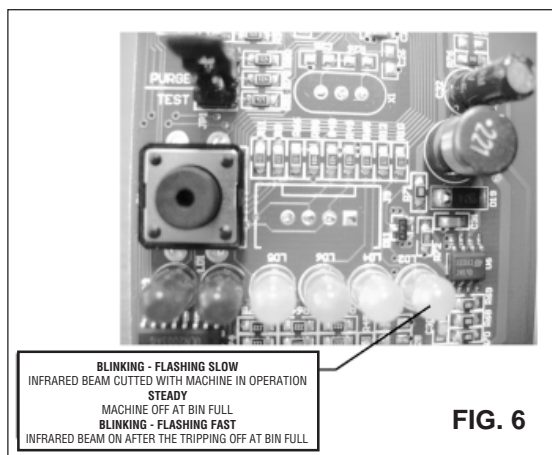

NOTE. The **ICE LEVEL CONTROL (INFRA-RED SYSTEM)** is independent of the temperature however, the reliability of its detection can be affected by dirt and scale sediment which may deposit directly on the light source and on the receiver.
To prevent any possible ice maker malfunction, due to negative affection of the light detector, it is advisable to follow the instructions for the **periodical cleaning of the light sensor** elements as detailed in the MAINTENANCE AND CLEANING PROCEDURES.

G. SETTING OF THE DISPENSING SELECTOR

Setting of the dispensing time on Electronic Standard Version

It's possible to modify the dispensing time to 1.5, 3, 5 or 10 seconds.

To modify the original setting time (5 seconds):

a) Push and hold the 4th switch "CONTINUOUS" for 10 seconds till the first 3 lights start to blink

b) Push the 1st switch (ICE) for 5 seconds
Push the 2nd switch (ICE+WATER) for 10 seconds
Push the 3rd switch (WATER) for 1.5 seconds
Push the 4th switch (CONTINUOUS) for 3 seconds

Setting of resume mode (default)

To modify the original resume mode (ICE) push for 5 seconds the desired switch ICE, ICE+WATER or WATER.

Dispensing Time and mode EVO Version



This is a touch free dispensing model, with only ICE configuration and no push button in the front panel.

Dispensing time is factory set at 3" not adjustable once a glass or a carafe is placed in front of the two Optical Dispensing Devices.

H. CHECK OF THE DISPENSING OPERATING MECHANISM

Electronic Version

There are two different versions of dispensing label; one with just ICE and CONTINUOUS push

buttons and a second with ICE/WATER + ICE/WATER and CONTINUOUS push buttons. To check for the correct operation of the dispensing mechanism:

a) Select first the Dispensing Mode by pushing the proper switch;

b) Place a glass or a carafe in front of the two Optical Dispensing Devices.

c) The dispensing drive motor and/or the water solenoid valve starts to operate with ice and/or water discharged through the bottom plastic spout.

The drive motor and/or the water solenoid valve remains in operation as per setting dispensing time unless the glass or carafe is removed.

Push the CONTINUOUS switch and check again for the dispensing mechanism operation as per steps above.

The drive motor and/or the water solenoid valve now remains in operation till the glass or carafe is removed.

EVO Version

a) Place a glass or a carafe in front of the two Optical Dispensing Devices.

b) The dispensing drive motor starts to operate with ice discharged through the bottom plastic spout.

The drive motor remains in operation as per factory set dispensing time 3" not adjustable.

I. If previously installed, remove the refrigerant service gauges and re-fit the unit service panels previously removed.

J. Instruct the owner/user on the general operation of the ice machine and about the cleaning and care it requires.

PRINCIPLE OF OPERATION

WATER CIRCUIT

The water enter in the machine through the water inlet fitting (which incorporates a strainer and it is located at the rear side of the cabinet) and then it goes to the water reservoir flowing through a float valve.

NOTE. The presence of the water in the float reservoir is detected by a system of two sensors which operates in conjunction with the P.C. Board. The two sensors use the water as a conductor to maintain a low voltage current flow between them. In case the water used is very soft (de-mineralized) or the float reservoir gets empty the current flow between the sensors become so weak or is no longer maintained that, as consequence, the P.C. Board shutoff the flaker operation with the simultaneous glowing of the **YELLOW LED** signalling "Shortage of water".

The float reservoir is positioned at the side of the freezing cylinder at such an height to be able to maintain a constant water level around the freezer auger. In fact, the water flows from the reservoir into the bottom inlet of the freezing cylinder to surround the stainless steel auger which is vertically fitted in the center of the freezer.

In the freezer the incoming water gets chilled into soft (slush) ice which is moved upward by the rotating action of the auger. The stainless steel auger that rotates counter-clockwise within the freezer, is powered by a direct drive gear motor and carries the ice upward along the refrigerated freezer inner walls and by doing so the ice gets progressively thicker and harder.

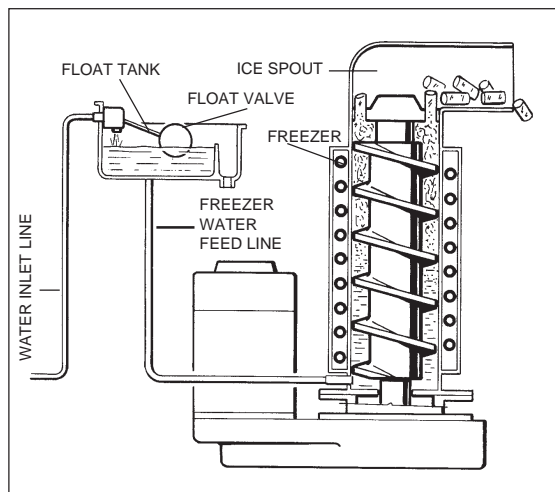

The ice, being constantly lifted up, meet the tooth of the ice breaker which is fitted on the top end of the auger, where it gets compacted, cracked and forced to change from vertical into horizontal motion to be discharged out, through the ice spout, into the storage bin.

By running the ice maker, i.e. by putting the unit under power, starts the automatic and continuous icemaking process which would not stop until the

ice storage bin gets filled-up to the level of the control "eyes" located on the sides of the ice spout. As the ice level raises to interrupt the light beam running between the two infrared lamps, the unit stops after six seconds, with the simultaneous glowing of the **YELLOW LED** signalling the "**Full Bin**" situation.

NOTE. The interruption of the light beam between the two light sensors is immediately signalled by the blinking of the **1st YELLOW LED** located on the front of the P.C. Board.

After about **6" of steady interruption** of the light beam the unit stops and the "**Full Bin**" **YELLOW LED** glows.

The six seconds of delay prevent the unit from stopping for any undue reason like the momentarily interruption of the light beam caused by the flakes that slides along the ice spout before dropping into the bin.

As some ice is dispensed from the storage bin, the light beam between the two sensors resumes and immediately the **1st YELLOW LED** blinks fast; six seconds later the ice machine restarts the ice making process and the **YELLOW LED** goes off.

REFRIGERANT CIRCUIT

The hot gas refrigerant discharged out from the compressor reaches the condenser where, being cooled down, condenses into liquid.

Flowing into the liquid line it passes through the drier filter, then it goes all the way through the capillary tube where it loses some of its pressure so that its pressure and temperature are lowered. Next, the refrigerant enters into the evaporator coil wrapped around the freezer inner tube.

The water being constantly fed at the interior of the freezer inner tube, exchange heat with the refrigerant circulating into the evaporator coil, this cause the refrigerant to boil-off and evaporate, thereby it changes from liquid into vapor.

The vapor refrigerant then passes through the suction accumulator and through the suction line where the refrigerant exchanges heat with the one flowing into the capillary tube (warmer) before being sucked into the compressor to be recirculated.

The refrigerant heat pressure is kept between two pre-set values **9÷10 bar -125÷140 psig** by the condenser temperature sensor which has its probe located within the condenser fins - in air cooled versions.

This condenser temperature sensor, when senses a rising of the condenser temperature beyond the pre-fixed limit, changes its electrical resistance and send a low voltage power flow to the **MICRO-PROCESSOR** of the P.C. Board which energizes, through a **TRIAC**, the **Fan Motor in ON-OFF mode**.

When the opposite situation occurs, i.e. the condenser temperature gets below the pre-fixed

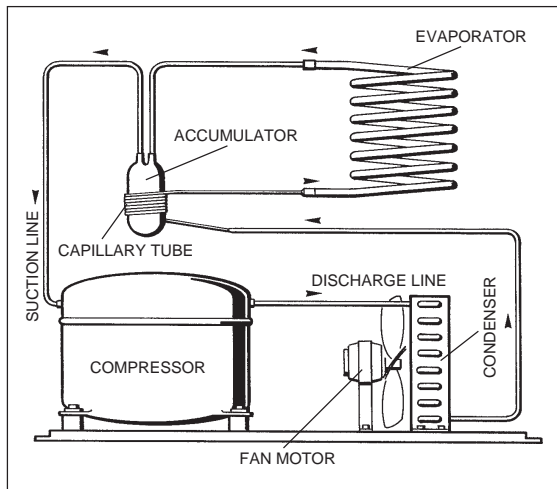

limit, the temperature sensor changes again its electrical resistance reducing therefore the current flow to the P.C. Board to cause a temporary stop of the Fan Motor.

NOTE. In case the condenser temperature probe senses that the condenser temperature has risen to **70°C (160°F)** for one of the following abnormal reasons:

CLOGGED CONDENSER
FAN MOTOR OUT OF OPERATION
AMBIENT TEMPERATURE HIGHER THEN 43°C (110°F)

it causes the total and immediate SHUT-OFF of the machine in order to prevent the unit from operating in abnormal and dangerous conditions. When the ice maker stops on account of this protective device, there is a simultaneous glowing of the **2nd RED LED**, warning the user of the **Hi Temperature** situation. After having eliminated the source of the excessive condenser temperature, to restart the ice machine it is necessary to push the **RE-SET** button that protrudes through the control box cover.

The **2nd RED LED starts blinking** and three minutes later the flaker unit resume its normal operating mode.

The refrigerant suction or Lo-pressure sets - in normal ambient conditions (21 °C) - on the value of **1 bar (14 psig)** after few minutes from the unit start-up.

This value can vary of **0.1 or 0.2 bar (1.5÷3 psig)** in relation to the water temperature variations influencing the freezer cylinder.

NOTE. If, after ten minutes from the unit start up, no ice is made and the evaporating temperature detected by the evaporator sensor results to be higher than **-1°C (30°F)** the ice maker stops and the **3RD WARNING YELLOW LED** blinks.

MECHANICAL SYSTEM

The mechanical system of the SCOTSMAN Nugget Ice Dispenser consists basically of a gear motor assembly which drives, through a ratched coupling, a worn shaft or auger placed on its vertical axis within the freezing cylinder.

The gear motor is made of a single phase electric motor with a permanent capacitor. This motor is directly fitted in the gear case through which it drives - in counter clockwise rotation at a speed of 9.5 r.p.m. - the freezer auger being linked to it by the ratched coupling.

NOTE. In the event the gear motor will tend to rotate in the wrong direction (counter-clockwise) or not rotating at all the unit will **stop immediately** with the glowing of the **3RD WARNING YELLOW LED** on account of the intervention of the **Electromagnetic Safety Device** - based on Hall Effect principle. After having diagnosed and eliminated the source of the failure, to restart the unit it is necessary to press the **RE-SET** push button or switch **OFF** and **ON** the power line main disconnect switch (Fig. 7). The **RED LED** will start blinking and after 3 minutes the ice maker will resume its total operations by running first the gear motor and then the compressor.

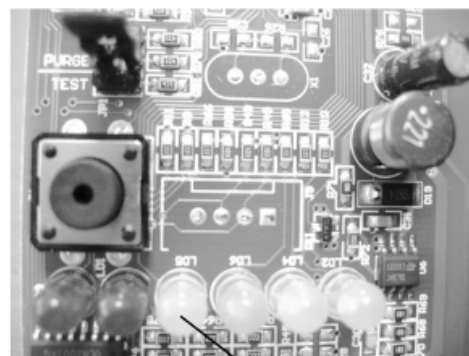

FIG. 7

STEADY
WRONG-NO-SLOW ROTATION GEAR MOTOR

When the gear motor rotating speed is slowed below **1300 r.p.m.** from the normal speed of 1400 r.p.m. the Electromagnetic Safety Device transmits an electrical signal to the MICROPROCESSOR to **stop immediately** the unit operations like it occurs for the wrong rotation, with the lighting-up of the **3RD YELLOW WARNING LED**. This to relieve from the excessive load all the electrical and mechanical components of the entire Drive System and extend their durability.

NOTE. After having diagnosed and eliminated the source of the gear motor slow rotation to restart the unit it is necessary to press the **RE-SET** push button or switch **OFF** and **ON** the power line main switch.

NOTE. Any time the machine stops in alarm the front four LED's start to blink.

REFRIGERANT METERING DEVICE:

capillary tube

OPERATING PRESSURES

(With 21°C ambient temperature)

Discharge pressure: 9 ÷ 10 bar (125 ÷ 140 psig)

Suction pressure: 1 bar (14 psig)

REFRIGERANT CHARGE (R 134 A): 370 gr

NOTE. Before charging the refrigerant system always check the type of refrigerant and quantity as specified on the individual ice machine dataplate.
The refrigerant charges indicated are relatives to averages operating conditions.

COMPONENT DESCRIPTION

A. EVAPORATOR TEMPERATURE SENSOR - BLACK 2 POLES CONNECTOR - MANUAL RESET

The evaporator sensor probe is inserted into its tube well, which is welded on the evaporator outlet line. It detects the temperature of the refrigerant on the way out from the evaporator and signals it by supplying a low voltage current flow to the P.C. Board Micro-Processor.

According to the current received, the micro-processor let the ice maker to continue its operations or not. In case the evaporating temperature, after 10 minutes from the unit start-up, does not go below -1°C (30°F) the evaporator sensor signal reaching the microprocessor is such to stop immediately the unit operation, with the 3rd Warning YELLOW LED that blinks.

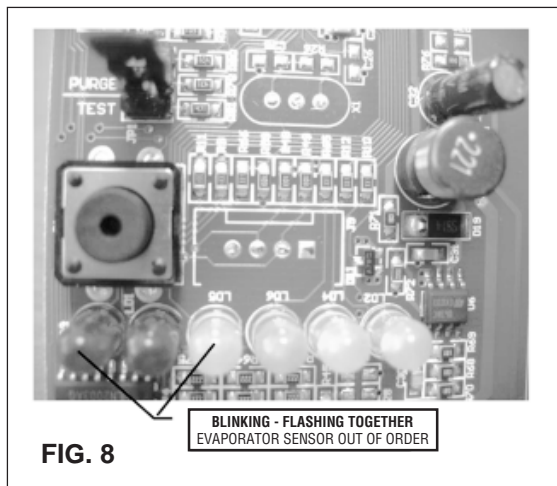

B. WATER LEVEL SENSOR - RED TWO POLES CONNECTOR - AUTOMATIC RESET

This sensor system consist of two small stainless steel rods vertically fitted on the inner face of the reservoir cover and electrically connected to the low voltage circuit of the P.C. Board. When the cover of the reservoir is positioned in its place the tips of both the rods dip into the reservoir water and detects and signals its presence by supply power back to the P.C. Board.

NOTE. In the event of **shortage of water** in the reservoir or, in case the water used is too soft (de-mineralized) to cause greater resistance to the current flow (conductivity lower than $30\mu\text{S}$) this sensor system causes the **shutoff of the machine**, to protect it from running with an interrupted or inadequate water supply. In this situation the **5th YELLOW LED** will glow to warn of the machine shutoff and the reason why.

C. CONDENSER TEMPERATURE SENSOR - WHITE TWO POLES CONNECTOR - MANUAL RESET

The condenser temperature sensor probe, located within the condenser fins detects the condenser temperature variations and signals them by supplying current, at low voltage, to the P.C. BOARD.

In relation to the different current received, the micro processor of the P.C. BOARD supplies, through a TRIAC, the power at high voltage to the fan motor so that it can cool the condenser and reduce its temperature.

In the event the condenser temperature rises and reaches 70°C the current arriving to the micro processor is such to cause an immediate and total stop of the machine operation with the glowing of the 2nd RED WARNING LED.

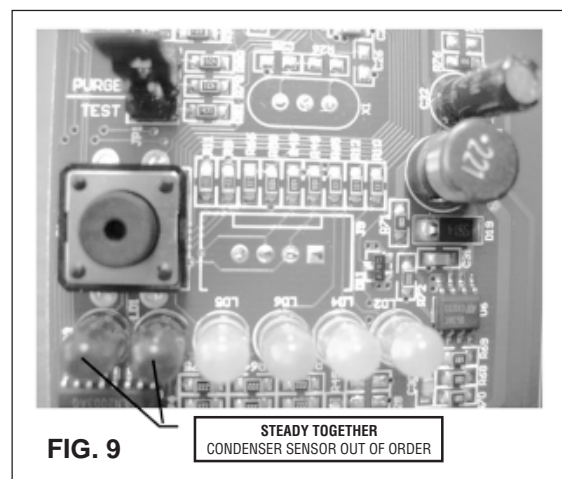

NOTE. To restart the unit after the shutoff caused by the hi condenser temperature, it is necessary to push the **RE-SET** button (after having remedied to the causes of unit stoppage) or to switch OFF and ON the power line main disconnect Switch.

D. GEAR MOTOR ROTATION AND SPEED SENSOR - RED FOUR POLES CONNECTOR - MANUAL RESET

This safety device is housed on top of the Drive Motor and detects - based on Hall Effect principle - the rotating speed and rotating direction of the drive Motor.

Should the rotating speed drop below 1300 r.p.m. the magnitude measured by this device is such to signal to the microprocessor to stop the unit and light-up the 3rd YELLOW LED. The same reaction occurs when the drive motor will tend to rotate in the wrong direction (counterclockwise) or it doesn't rotate at all.

NOTE. To restart the unit after the shutoff caused by this safety device, it is necessary first to eliminate the cause that has generated the intervention of the device and then press the **RE-SET** push button or switch OFF and ON the power line main disconnect switch.

E. ICE BIN LEVEL LIGHT CONTROL - BLACK FOUR POLES CONNECTOR - AUTOMATIC RESET

The electronic ice bin level control, located into the ice spout, has the function to stop the operation of the ice machine when the light beam between the light source and the sensor gets interrupted by the flake ice which accumulates in the spout. When the light beam is interrupted the **1st YELLOW LED** located in the front of the P.C. BOARD blinks; in case the light beam gets interrupted for as long as 6 seconds, the ice machine stops with the glowing-up of the **same YELLOW LED** to monitor the full ice bin situation. The 6 seconds of delay prevents that any minimum interruption of the light beam due to the regular ice chuting through the ice spout may stop the operation of the unit.

As soon as the ice is dispensed out (with the resumption of the light beam between the two infrared sensor of ice level control) the **YELLOW LED** blinks fast and after 6 seconds the ice machine resume its operation with the simultaneous extinguishing the **YELLOW LED**.

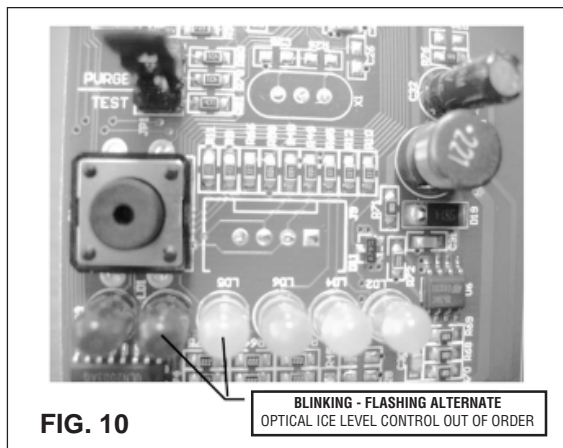

FIG. 10

F. ICE/WATER OPTICAL DISPENSING DEVICE - BLUE FOUR POLES CONNECTOR

Located on the front of the dispensing area it consists of the combination of an infrared Transmitter and Receiver.

When a glass or a carafe is placed in front of the Infrared sources, the optical device transmits a signal to the PC Board that is equivalent to activate the dispensing drive motor which, in turn, put in rotation a dispensing vane that pushes the ice towards a rectangular opening located in the bottom of the storage bin.

Elapsed the dispensing time or after have removed the glass/carafe, the infrared resume its original condition switching off the dispensing drive motor.

G. FRONT DISPENSING SELECTOR/ DISPLAY - BLACK SIX POLES CONNECTOR (NOT USED ON EVO VERSION)

Placed in the upper front part of the dispensing area it is used to select, according to the version of the machine:

- a) Ice (first switch)
- or
- a) Ice (first switch)

- b) Ice and water (second switch)
 - c) Water - not chilled - (third switch)
- It is also possible to set up for "continuous" dispensing operation just pushing the fourth switch before or after the selection of the dispensed product. Once completed the dispensing selector/display resumes its original dispensing setting mode.

NOTE. It is possible to modify the original resume mode (default) by pushing for 5 seconds the corresponding switch (all machines are supplied from the factory in the ICE dispensing mode).
 It is also possible to modify the dispensing time controlled by the PC Board to 1.5, 3, 5 and 10 seconds by:
 a) Push and of the 4th switch "continuous" for approximately 10 seconds till the first 3 lights start to blink
 b) Pushing the 1st switch (ICE) is equivalent to 5 seconds
 Pushing the 2nd switch (ICE+WATER) is equivalent to 10 seconds
 Pushing the 3rd switch (WATER) is equivalent to 1.5 seconds.
 Pushing the 4th switch (CONTINUOUS) is equivalent to 3 seconds.

H. P.C. BOARD (Data processor)

The **P.C. BOARD**, fitted in its plastic box located in the right side of the unit, consists of two separated printed circuits one at high and the other at low voltage, protected by three fuses, integrated with a RE-SET button. Also it consists of six aligned **LEDS** monitoring the operation of the machine and of input terminals for the leads of the sensor probes as well as input and output terminals for the leads of the ice maker electrical wires.

The **P.C. BOARD** is the brain of the system and it elaborates, through its micro processor, the signals received from the sensors in order to control the operation of the different electrical components of the ice maker (compressor, gear motor, etc.) as well as the dispensing of the ice and water.

The six **LEDS**, placed in a row in the front of the **P.C. BOARD**, monitor from right to left the following situations:

RED LED
ON all the time
 - Unit shut-off due to a **too hi-condensing temperature > 70°C**

Blinking
 - 3 minutes start up delay time

YELLOW LED
ON all the time
 - Unit shut-off due to the **wrong rotation direction** of gear motor
 - Unit shut-off due to the **too lo speed** of gear motor

Blinking
 - Unit shut-off due to a **too hi-evaporating temp. >-1°C** after 10 min of operation

GREEN LED

- Unit under electrical power

YELLOW LED

- Unit shut-off due to a **too lo-water level** into float tank

YELLOW LED

On all the time

- Unit shut-off at storage bin full

Blinking slow

- Infrared beam cutted with machine in operation

Blinking fast

- Infrared beam ON after tripping OFF at storage bin full

BOTH RED LEDS STEADY

- Condenser sensor Out of Order

YELLOW AND RED BLINKING TOGETHER

- Evaporator sensor Out of Order

YELLOW AND RED BLINKING ALTERNATE

- Optical Ice Level Control Out of Order

- Push and hold the PC Board push button
- Switch ON the machine keeping pushed the PC Board push button till all LEDs are ON
- Release the push button

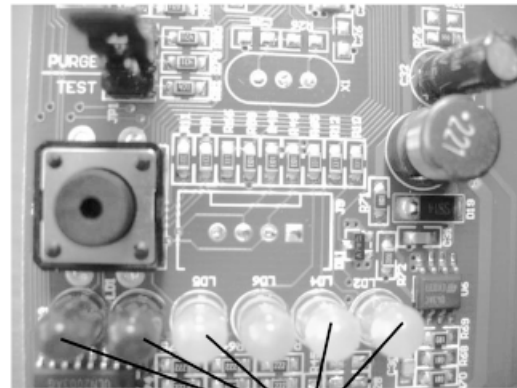

ALL STEADY
CALIBRATION OF PC BOARD & OPTICAL ICE LEVEL CONTROL

JUMPERS

The PC Board is also equipped with three Jumpers as detailed in the bottom drawing:

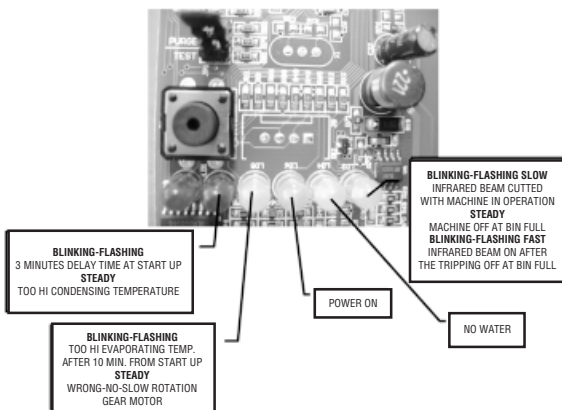
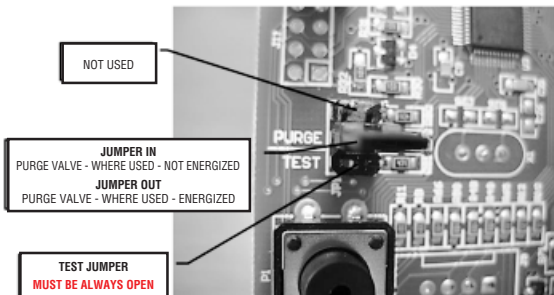

In case the TEST Jumper is closed, the machine starts up immediately once connected to the power with and it will run for few minutes only.

After that the machine Trips OFF with the Leds of the PC Board blinking.

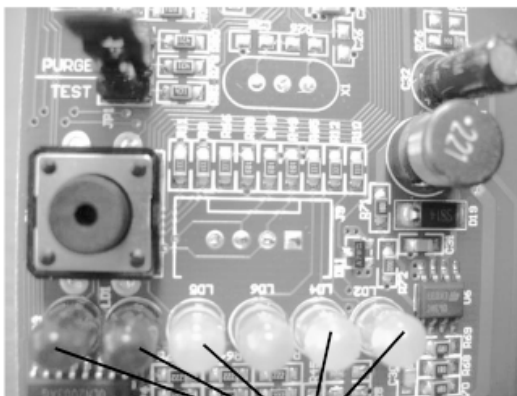
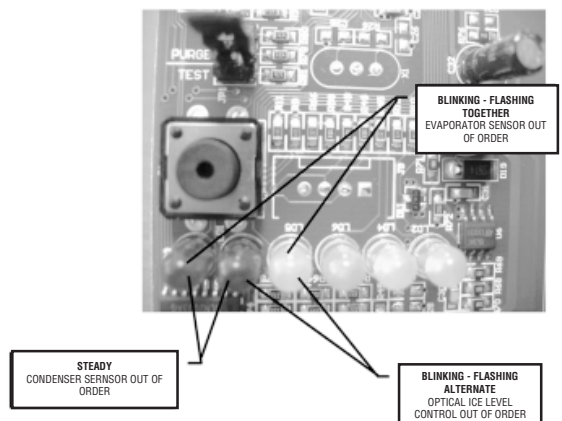

BLINKING - FLASHING ALL TOGETHER
TEST JUMPER IN

CALIBRATION OF ICE LEVEL CONTROL/PC BOARD

Any time the PC Board and/or the Ice Level Control are replaced it necessary to perefom the calibration as per following instructions:

- Switch OFF the machine

I. FLOAT RESERVOIR

The float reservoir consists of a plastic water pan on which is fitted a float valve with its setting screw. The float valve modulate the incoming water flow to maintain a constant water level in the reservoir, level that corresponds to the one in the freezing cylinder to ensure proper ice formation and fluidity.

On the inner side of the reservoir cover are fitted the two water level sensors which detects the presence or the shortage of water in the reservoir.

NOTE. It is very important to make sure of the correct fitting of the cover on the reservoir in order to enable the sensor to efficiently control the water situation avoiding undue shutoff interventions.

J. FREEZING CYLINDER (EVAPORATOR)

The freezing cylinder is made of a stainless steel vertical tube on which exterior is wrapped around the cooling coil with the evaporating chamber and in its interior is located the auger which rotates on its vertical axis and it is maintained aligned by the top and bottom bearings. A water seal system is located in the bottom part of the freezer while at the top end is fitted the ice breaker.

The water constantly flowing into the cylinder bottom part, freezes into ice when in contact with the cylinder inner walls. The ice is then lifted up by the rotating auger and compacted and forced out by the ice breaker.

K. ICE BREAKER

The ice breaker is made by several rectangular openings where the ice is forced to pass through. By undergoing this, the ice loses its excess of water content so it drops into the bin in hard dry bits of ice.

In the ice breaker it is housed the top bearing which is made of two rolls bearings positioned to withstand the auger axial and radial loads. This bearing is lubricated with a food grade - water resistant grease.

NOTE. It is advisable to check the conditions of both the lubricant grease and the bearings every six months.

L. DRIVE GEAR MOTOR

This motoreducer is made of a single phase electric motor with permanent capacitor directly fitted on a gear box.

The drive motor rotor is kept aligned on its vertical axis by two ball bearings permanently lubricated. The gear case contains a train of three spur gears the first one of which is in fiber

to limit the noise level. All the three gears are encased in case bearings and are covered by lubricant grease (MOBILPLEX IP 44).

Two seal rings, one fitted on the rotor shaft and the other on the output shaft keep the gear case sealed.

However, the interior can be inspected and serviced by unbolting the two halves of the aluminium gear case housing.

The gear reducer output shaft is connected to the freezer auger by a ratched coupling which is made of two toothed halves that engages themselves only if turned in the correct direction namely, conterclockwise.

M. FAN MOTOR (Air cooled version)

The fan motor is controlled through the P.C. BOARD and the TRIAC by the condenser temperature sensor. Normally it operates to draw cooling air through the condenser fins.

In cold ambient situation, the fan motor can run at intermittance as the condenser pressure must be kept between two corresponding head pressure values.

N. COMPRESSOR

The hermetic compressor is the heart of the refrigerant system and it is used to circulate and retrieve the refrigerant throughout the entire system. It compresses the low pressure refrigerant vapor causing its temperature to rise and become high pressure hot vapor which is then released through the discharge valve.

O. ICE DISPENSER DRIVE MOTOR

Located on the upper side of the storage bin, it turn by a milled shaft the dispensing vane placed inside the round storage bin.

By rotating, the dispensing vane pushes the ice towards the bottom rectangular opening so to force the nugget ice to go through the bottom outlet spout.

P. STORAGE BIN

Round shaped it is located in the front of the ice machine and has the main reason to store the nugget ice produced by the evaporator till it reaches its maximum level controlled by an infrared optical system. In its bottom is placed the ice spout as well as the water drain hole.

Inside the ice spout opening is also located the water outlet tube connected to the solenoid valve.

Q. DISPENSING WATER SOLENOID VALVE (NOT USED ON EVO VERSION)

Energized and controlled by the PC Board, it allows a metered quantity of not chilled water to be dispensed through the same opening of the ice.

WIRING DIAGRAM - DISPENSING BOARD VERSION

AIR AND WATER COOLED

230/50/1

BK	BLACK
BN	BROWN
BU	BLUE
GY	GREY
GNYE	GREEN-YELLOW
GN	GREEN
RD	RED
YE	YELLOW
WH	WHITE
OG	ORANGE
PK	PINK

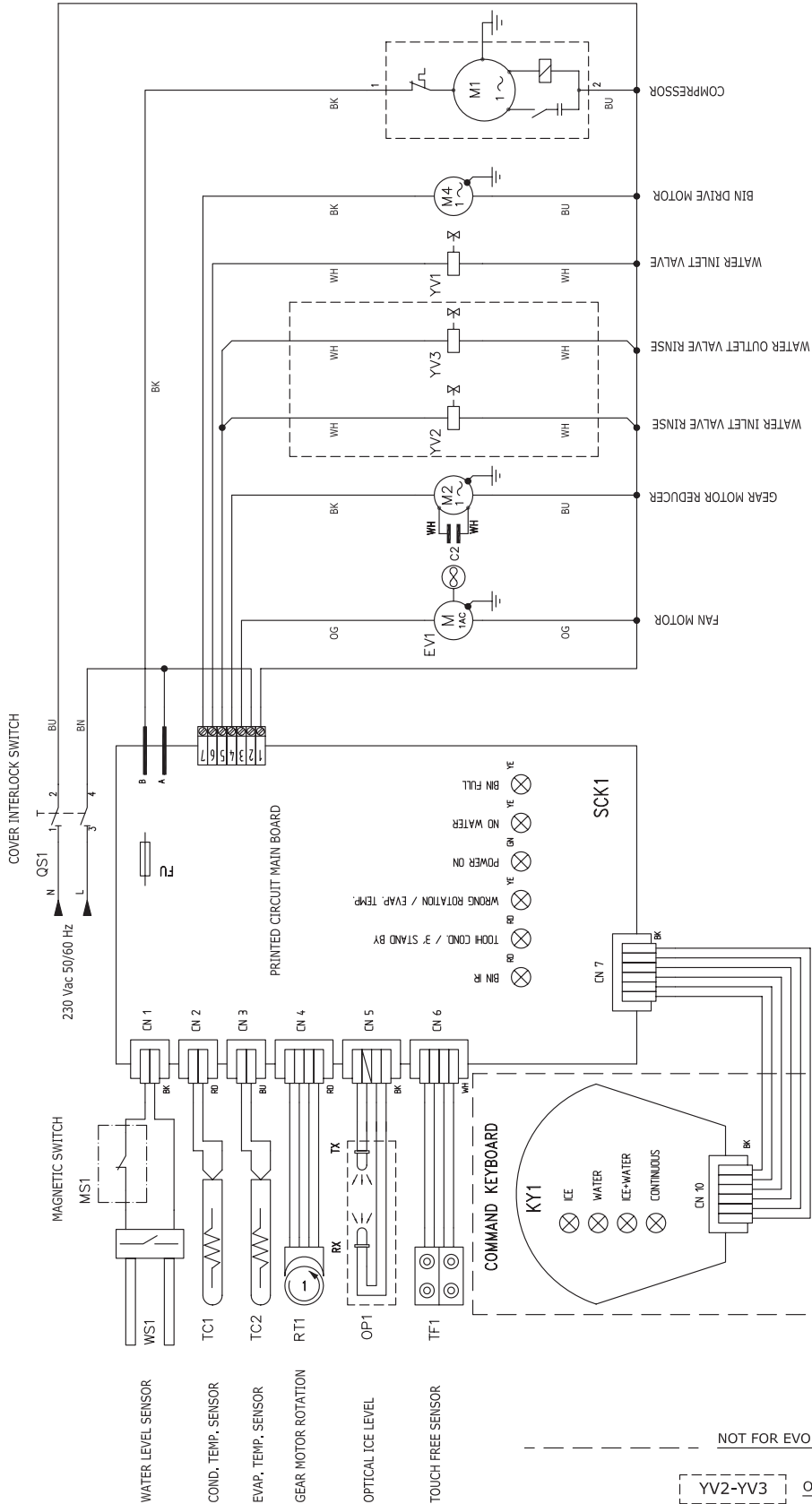

WIRING DIAGRAM - PUSH BUTTONS VERSION AIR AND WATER COOLED 230/50/1

BK	BLACK
BN	BROWN
BU	BLUE
GY	GREY
GNYE	GREEN-YELLOW
GN	GREEN
RD	RED
YE	YELLOW
WH	WHITE
OG	ORANGE
PK	PINK

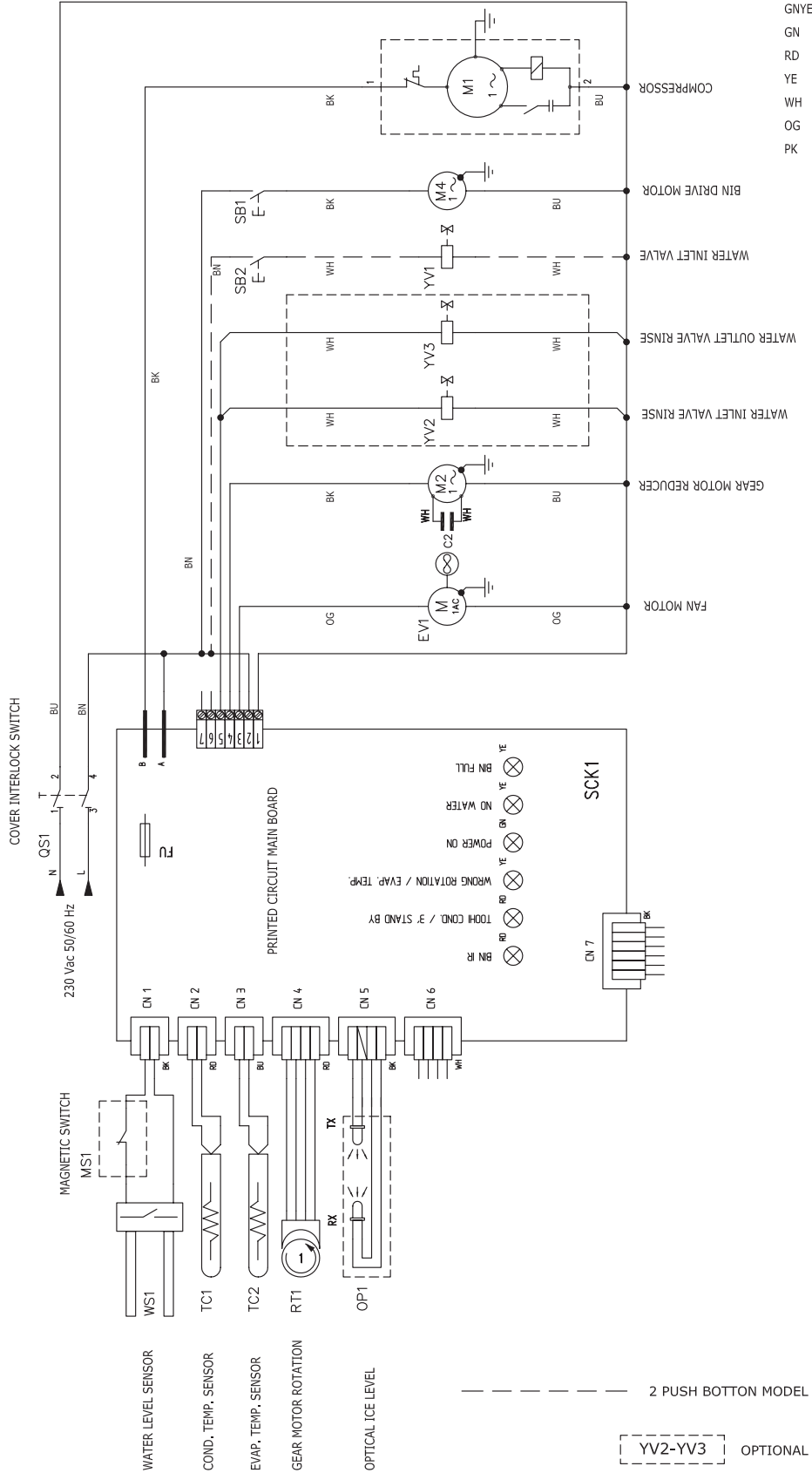

SERVICE DIAGNOSIS

SYMPTON	POSSIBLE CAUSE	SUGGESTED CORRECTION	
Unit will not run No LED lighted-up	Blown fuse in P.C.Board	Replace fuse & check for cause of blown fuse	
	Master switch in OFF position	Turn switch to ON position	
	Inoperative P.C.Board	Replace P.C.Board	
	Loose electrical connections	Check wiring	
6th Yellow LED glows	Dirty ice level control	Clean ice level control	
5th Yellow LED glows	Shortage or too soft water	See remedies for shortage of water or install a mineral salt metering device	
2nd LED glows	High head pressure	Dirty condenser. Clean Inoperative fan motor. Replace	
3rd Yellow LED blinks	Too hi evap. temperature Shortage or lack of refrigerant	Check and charge refrigerant system	
3rd Yellow LED glows	Gear motor tends to run on reverse	Check gear motor capacitor	
	Too low gear motor rotating speed	Check rotor bearings, freezer bearings and interior of freezer for scores. Replace whatever worn or damaged.	
	No rotation of gear motor	Check for power to drive motor (16 A fuses) Check for stator winding	
	Gear motor starts and stop after a while	Check for correct operation of drive motor magnetic sensor Check for correct magnetic capacity of magnetic cylinder	
Compressor cycles intermittently	Low voltage	Check circuit for overloading Check voltage at the supply to the building. If low, contact the power company	
	Non-condensable gas in system	Purge the system	
	Compressor starting device with loose wires	Check for loose wires in starting device	
Low ice production	Capillary tube partially restricted	Blow charge, add new gas & drier, after evacuating system with vacuum pump	
	Moisture in the system	Same as above	
	Low water level in the freezer	Adjust to approx 20 mm below ice spout	
	Shortage of refrigerant	Check for leaks & recharge	
	Pitted or stained auger surface	Clean or replace auger	

SERVICE DIAGNOSIS

SYMPTON	POSSIBLE CAUSE	SUGGESTED CORRECTION
Wet ice	Ambinet temperature too high High water level in the freezer Faulty compressor	Move unit to cooler location Lower to approx. 20 mm below ice spout Replace
Machine runs but makes no ice	Water not entering in the freezer Gear stripped Moisture in the system	Air lock in feed line to freezer. Clogged feed line to freezer. Clean it Check and repair Purge, replace drier and re-charge
Water leaks	Water seal leaking Water feed line to freezer leaking Float valve not closing	Replace water seal Check and fasten hose clamp Check and adjust float valve setting screw
Excessive noise or chattering	Mineral or scale deposit on auger and inner freezer walls Low suction pressure Water feed line to freezer clogged Low water level into freezer	Remove and manually polish auger and inner walls of freezer barrel using emery paper Add refrigerant to rise suction pressure Vent and clean it Adjust to approx. 20 mm below ice spout
Gear motor noise	Worn rotor bearings Shortage or poor lubricant in gear case Gear case bearings and gear racers worn out	Check and replace Check for proper lubricant opening gear case. Top of gears must be covered with lubricant Check and replace worn parts
Shortage of water	Strainer at water inlet fitting clogged Float reservoir water nozzle clogged-up	Remove strainer and clean Remove float valve and clean nozzle

MAINTENANCE AND CLEANING INSTRUCTION

A. GENERAL

The periods and the procedures for maintenance and cleaning are given as guides and are not to be construed as absolute or invariable. Cleaning, especially, will vary depending upon local water and ambient conditions and the ice volume produced; and, each icemaker must be maintained individually, in accordance with its particular location requirements.

B. ICEMAKER

The following maintenance should be scheduled at least two times per year on these icemakers.

1. Check and clean the water line strainer.
2. Remove the cover from the float reservoir - care to do not damage the two water sensors - and depress the float to make sure that a full stream of water enters into the reservoir.
3. Check that the icemaker is levelled in side to side and in front to rear directions.
4. Check that the water level in the water reservoir is below the overflow but high enough that it does not run out of the spout opening.

NOTE. *The float must close positively the incoming water flow when the rubber housed in the setting screw, is perpendicular to the water nozzle.*

5. Clean the water system, water reservoir and the interior of freezing cylinder using a solution of SCOTSMAN Ice Machine Cleaner. Refer to procedure C cleaning instructions and after cleaning will indicate frequency and procedure to be followed in local areas.

NOTE. *Cleaning requirements vary according to the local water conditions and individual user operation.*

6. If required, polish the two sensor rods secured to the float reservoir cover, heavy scale sediment on them can be removed with the help of a bit of SCOTSMAN Cleaner plain.
7. With the ice machine and fan motor OFF clean condenser using vacuum cleaner, whisk broom or non metallic brush taking care to do not damage the condenser temperature sensor.
8. Check for water leaks and tighten drain line connections. Pour water into the sink to be sure that drain line is open and clear.

9. Check the ice level control sensor to test shut-off. Put your hand between the light source and the receiver on the upper side of the storage bin so to cut off the light beam for at least 6 seconds.

This should cause the immediate blinking of the 1st YELLOW LED located in the front face of P.C. Board and, 6 seconds later, the total stopping of the ice maker with the simultaneous light up of the same Yellow LED.

Within few seconds from the removal of the hand from between the sensor lights the ice maker resume its operation.

NOTE. *The ice level control uses devices that sense light, therefore they must be kept clean enough so they can "see". Every month clean/wipe the sensing "eyes" with a clean soft cloth.*

10. Check for refrigerant leaks and for proper frost line, which should frost as far as approx. 20 cm (8") from the compressor. When doubtful about refrigerant charge, install refrigerant gauges on corresponding Schröder valves and check for correct refrigerant pressures. (See Operating pressure at page 21 of this manual).

11. Check that fan blades move freely and are not touching any surfaces.

12. Remove the ice spout cover, unloose the bolt securing the casting ice sweep and remove it; then inspect the top bearing, wipe clean of all grease and apply a coating of food grade water proof grease P/N 263612.00.

NOTE. *It is recommended to use only food grade and waterproof grease to lubricate the freezer top bearing.*

13. Turn the ice dispensing spout and remove it. Wash and sanitise it.

14. Remove the sink grill for washing and sanitising.

C. CLEANING INSTRUCTIONS OF WATER SYSTEM

1. Switch OFF the Master disconnect switch on the power line.
2. Remove the top panel and later the top cover of storage bin with the dispensing drive motor.
3. Remove all ice stored in the bin to prevent it from getting contaminated with the cleaning solution.

4. Shut close the water shutoff valve on water line.
5. Remove the left side panel to gain access to the water reservoir.
6. Remove the float reservoir cover and with a piece of copper wire jump the two water level sensors.
7. Remove the right service panel and unloose the drain plug from the water purge tube so to drain out all water from the freezer. Then re-plug the purge tube.

CLEANING

8. Prepare the cleaning solution by diluting in a plastic container two liters of warm water (45°-50°C) with a 0,2 liters of **SCOTSMAN** Ice Machine Cleaner.

WARNING. The SCOTSMAN Ice Machine Cleaner contains Phosphoric and Hydroxyacetic acids. These compounds are corrosive and may cause burns if swallowed, DO NOT induce vomiting. Give large amounts of water or milk. Call Physician immediately. In case of external contact flush with water. KEEP OUT OF THE REACH OF CHILDREN

9. Pour the cleaning solution into the water reservoir till reaches the proper level.
10. After 15 minutes switch ON the Master switch to start the unit.
11. Wait till the machine starts to discharge ice, then continue to slowly pour the cleaning solution into the water reservoir taking care to maintain the level just below the overflow.

NOTE. *The ice made with the cleaning solution is slushy and coloured also, it may tend to loose fluidity creating some resistance in being elevated and extruded; this situation can be heard by the creaking noise made by the ice.*

Should this occur it is recommended to stop for few minutes the ice machine in order to allow the ice in the freezer to partially melt.

12. When all the cleaning solution has been used up, open the water shutoff valve to allow new fresh water to flow into the reservoir. Let the unit to continue to run until the ice resumes the normal colour and hardness.

13. Stop the icemaker and pour warm water on the ice deposited into the storage bin to melt it up.

NOTE. *DO NOT use ice produced with the cleaning solution. Be sure none remains in the bin.*

SANITATION

14. Pour into the water reservoir 1 cc. (approx 20 drops) of Scotsman Sanitiser (Antialgae P/N 264000.02) then switch the unit ON.

15. Left the unit running for approx 10 minutes then remove the copper wire used to jump the two sensors for the water level and place back correctly the cover on the float reservoir.

NOTE. *DO NOT use ice produced with the sanitising solution.*

16. With a sponge moisted with a sanitising solution, wipe clean all the bin interior surfaces.

REMEMBER. *To prevent the accumulation of undesirable bacteria it is necessary to sanitise the interior of the storage bin with an anti-algae disinfectant solution every week.*