

Laboklav



Steriltechnik AG

Dampfsterilisatoren Steam sterilizers



Type 25 Liter

User manual

edition 04/2009

SHP Steriltechnik AG

Schloss Detzel 1
D-39345 Detzel Schloss / Satuelle

Tel: +49 (0) 39058 97 62- 0
Fax: +49 (0) 39058 97 62- 22
E-Mail: info@shp-steriltechnik.de
Internet: www.shp-steriltechnik.de

Please read these user instructions before starting the use of the steam sterilizer! It is necessary to keep this user manual over the complete life cycle of the sterilizer nearby the unit.

Indications included in this manual and labeled **warning**, **important** and **attention** are very important and to draw attention to them. They are marked with the following graphical symbols.

Warning



Failing to observe these warnings can cause injury and even death. This symbol also means that an operator must acquaint with a suitable passage in the manual.

Important



This symbol denotes important indications for example to prevent sterilizer or load damage.

Attention



Observing the texts marked with this symbol facilitates operation of the sterilizer.

General Warnings:



Access to sterilizer operations manual should be restricted only to persons authorized to operate a sterilizer



During an installation of a sterilizer, after maintenance performed by technical staff and during power outlet exchange, the verification of null electric potential of the elements being touched by users should absolutely be performed by authorized staff.

Table of content

	page
I. General application, construction and use of Steam sterilizer line Laboklav 25	5
II. Steam sterilizer Laboklav 25 technical data	6
III. Programs available in steam sterilizer line Laboklav 55 - 195	8
Standard programs	8
Programs with vacuum (versions V and MV)	9
IV. Operating the steam sterilizer Laboklav 25	12
1. List of delivered parts	12
2. Installation	12
• Preparation of the unit	12
• Power supply	12
• Water supply	12
3. Installation and operation	13
• Switching on	13
• Loading the device	13
• Touch panel	14
• Program change	15
• 2. Display level	15
• Program start	15
• STOP button	15
• Changing program parameters	16
5. Error handling	19
6. Operating the sterilizer – generall information	20
• Preheating the chamber	20
• Preparation of sterilization goods	20
• Cancellation of program cycle	21
• Draining the condensate	21
• Documentation of sterilization cycle	21
V. Maintenance	23
• Regular cleaning, maintenance and service activities	24
• Cleaning	24
• Check of the safety valve(s)	25
• Changing the venting air filter	25
• Liste der Verbrauchsmaterialien	25
VI. Description of safety devices	26
VII. Additional Information	27
• Definition of feed water quality	27
• Service and maintenance	27

I. General application, construction and use of Steam sterilizer line Laboklav 25

The steam sterilizer type Laboklav 25 is equipped with a chamber by 25 Liter usable chamber volume. It is constructed for the steam sterilization of instruments, materials for non medical use and liquids. All versions contain a thermo lock acc. to IEC 61010-2-42. Different versions depending on the use of the sterilizers are available.

In Basic version (Laboklav 25 B) the sterilization of solid materials like instruments and glass ware, waste and liquids is possible. Instruments should be sterilized in unwrapped form. Please be sure that the materials to sterilize are allowed to be sterilized by steam sterilization in the correct temperature range you want to sterilize them. We suggest to do not sterilize wrapped, porous and hollow materials with basic units. The result is not defined and not possible to validate.

The version with fast liquid cooling option (Laboklav 25 M) is equipped to make the cooling process of liquids faster than self cooling process can be. The use of the active cooling process is constructed for the use of not tightly closed flasks! Reduce of process time of cooling process is about 40 % compared with basic version! In consequence of the active cooling process happens a loss of liquids by 6 – 12 % depending of the pressure reduce speed (programmable by service).

The vacuum version (Laboklav 25 V) includes a membrane vacuum pump. This makes the steam sterilization process safe for wrapped, porous and hollow materials. Additionally this version includes the possibility of drying of the materials.

The different options are possible to combine in one unit (Laboklav 25 MV).



The manufacturer is not liable or responsible for defects or indefinitely results if the sterilizer is not under intended use.

The steam sterilizer type Laboklav 25 allows a fully automatic process cycle. That includes deaeration, heating, sterilization, pressure remove and cooling or drying function (optional if included in the actual version). All steps for an automatic process are controlled by a microprocessor control board. The actual status is shown on a graphic display and includes all important information for the user to operate the device. The supported temperature range of the sterilization process is 103°C to 135°C. The typical temperatures of 121°C and 134°C are programmed for different sterilizing situations and different materials. All program positions can be reprogrammed by special trained engineers / service stuff.

The steam sterilizer type Laboklav 25 includes the following additional advantages:

- Automatic preheating to reach defined condition in the start situation in each program separately to define. This function is especially developed for fractionated prevacuum process to reduce the condensate in the chamber and on the sterilization goods
- Fully automatic deaeration of the sterilization goods by fractionated prevacuum (in vacuum option only) or pressure purge process for solids and gravity process for liquid goods.
- Use of the principle of hot stone for the steam production reduces the use of water and decreases the heating time of the device. That make the process much more economic than the typical steam generation process in a classic steam generator
- Cooling process using normal air driven by a fan. That reduces the need of expensive demineralized water.
- Protection of the drain on house installation side by using internal condensate tank.
- Microprocessor controlled process for fully automatic use

Total view of the steam sterilizer Laboklav 25

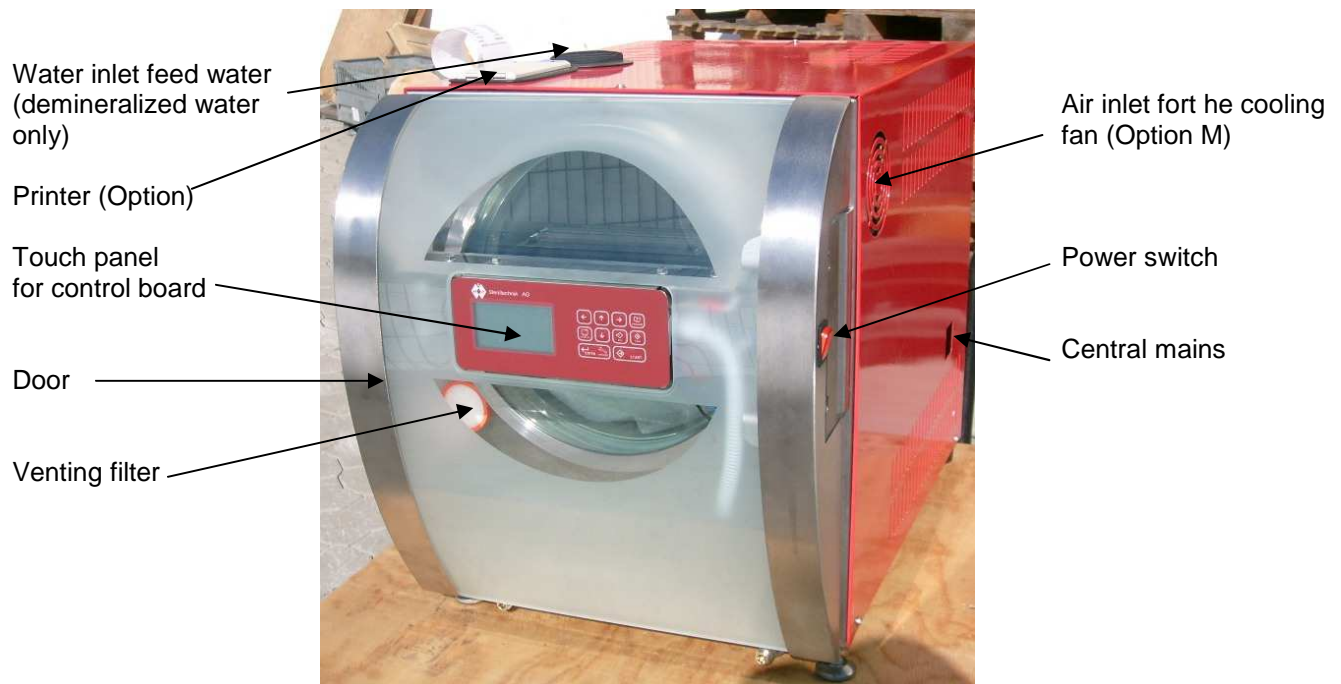

II. Steam sterilizer Laboklav 25 technical data

Overall dimension (free standing unit)(W x H x D).....	435 x 560 x 680 mm
Footprint (Bench top unit)(W x D).....	500 x 570 mm
Weight (netto).....	ca. 60 kg
Volume Feed water tank.....	ca. 3 l
Volume Condensate tank.....	ca. 3 l
Maximum Load:	
- Instruments	5 kg
- Textiles	2 kg
- Liquids	5 Liter Total volume

Sterilizer chamber:

Total volume	ca. 25 l
Chamber dimension (φ x D)	φ 265 x 450 mm
usable Volume	ca. 25 l
usable chamber dimension.....	ca. 200 x 200 x 430 mm
Maximum allowable pressure (PS)	2.8 bar
Maximum allowable temperature (TS)	138°C
Working pressure safety valve	2.8 bar

Power supply:

Voltage	230V~ (±10%), 50 Hz, 16A
Working power.....	2,5 kW
Averaged power consumption per cycle	0,75 kWh
Protection class	I

Water supply:

Destilled or demineralized Water

(acc. to annex C EN 13060:2004)

Averaged feed water consumption per cycle..... ca. 0,7 l

Storing conditions:

Temperature 5 ÷ 40°C

Humidity max. 85%

Computer interface:

- serial interface RS 485

Printer (optional)

Programs:

5 predefined programs not code protected:

- P1: Instruments 134°C, 15 min, Drying - in Version V and MV
- P2: Instruments 121°C, 20 min, Drying - in Version V and MV
- P3: Waste 134°C, 20 min
- P4: Liquids 121°C, 20 min, active cooling – in Version M and MV
- P5: Liquids 121°C, 20 min, passive cooling

5 further programs (P6 – P10) predefined like P1, code protected,.

2 Testprograms (Bowie & Dick-Test, P11, Vacuumtest, P12) - in Version V and MV

III. Programs available in steam sterilizer line Laboklav 55 - 195

Standard programs

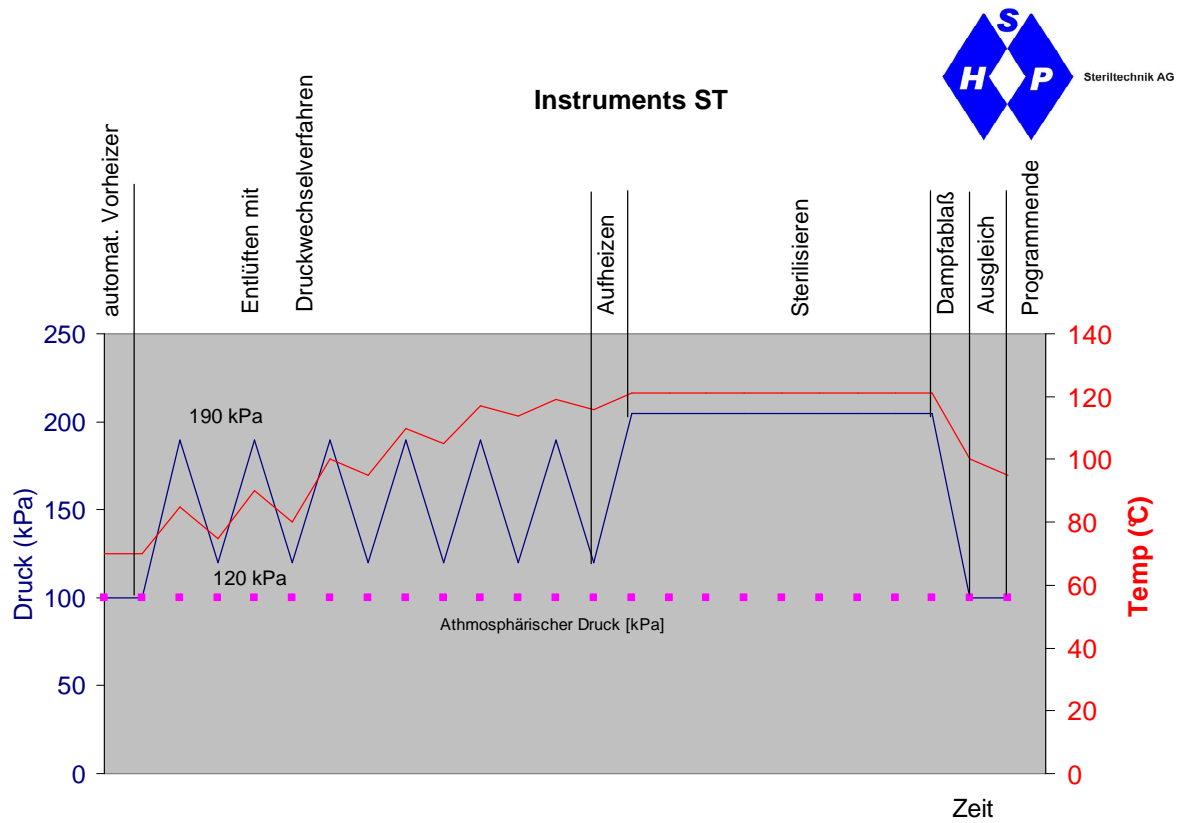

Program Instruments ST available in version Laboklav 25 B and M

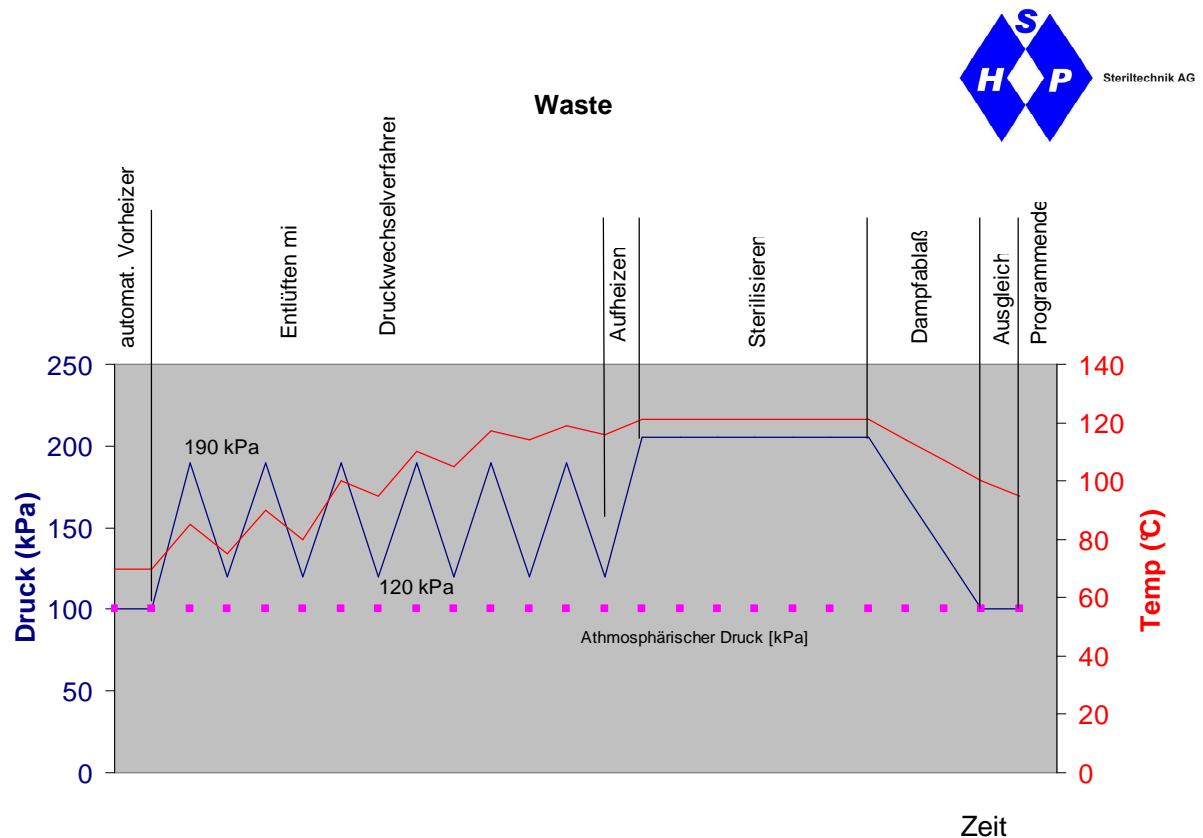

Program Waste available in version Laboklav 25 B and M



Liquids

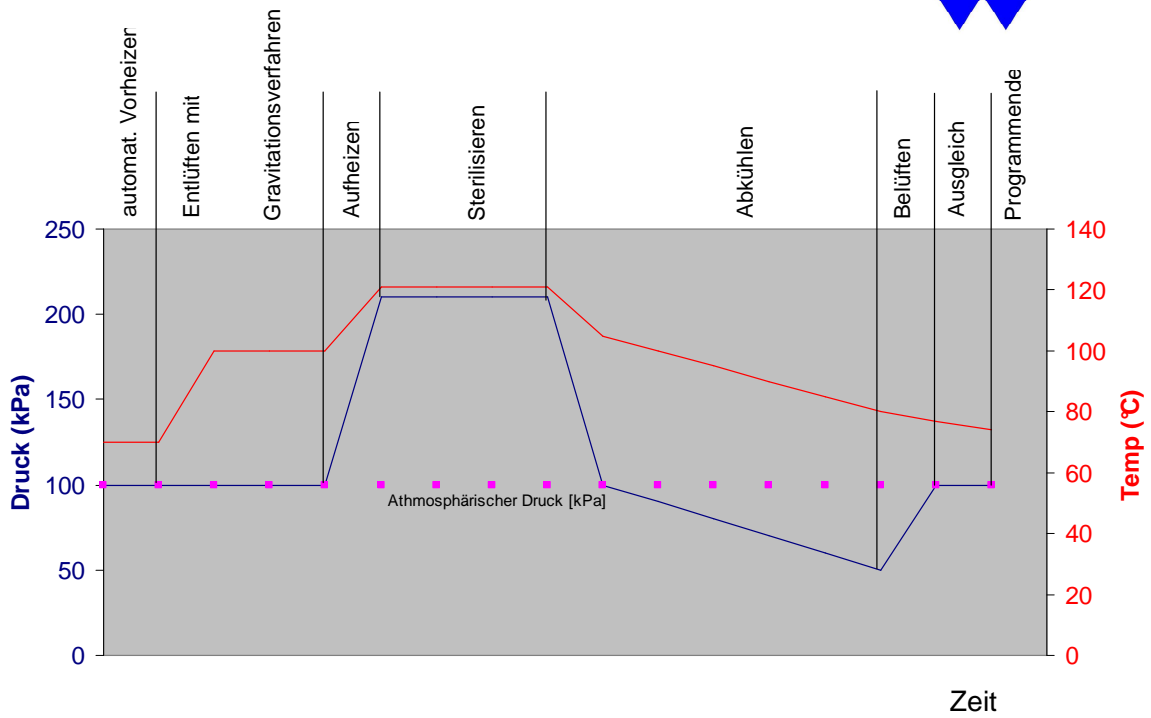

Program Liquids in all Laboklav 25 cooling time differs in version M in P4 / P5

Programs with vacuum (versions V and MV)

Instruments (incl. drying)

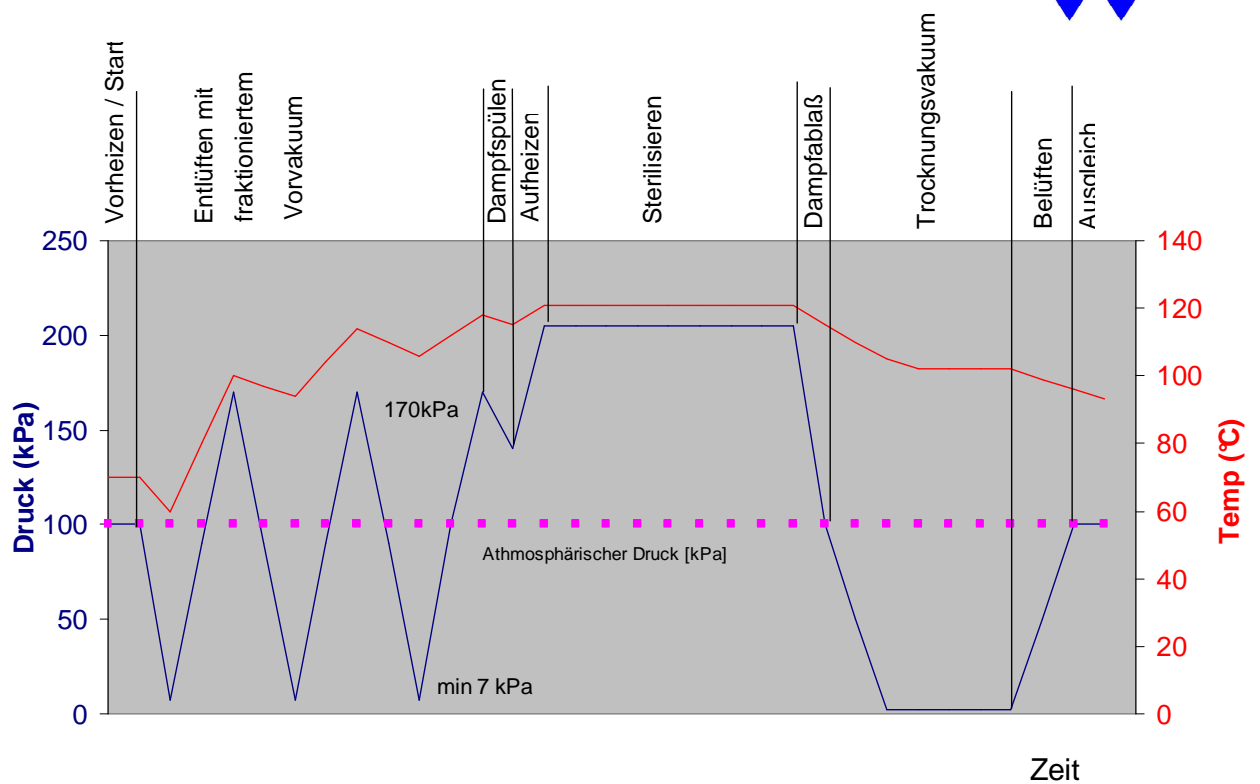

Program Instruments FV in version Laboklav 25 V and MV

Description of program steps

The sterilizing process in steam sterilizer type Laboklav 25 (see drawings above) contains the following program steps:

- **Preheating** (Vorheizen):

The steam generator and if programmed the chamber is preheated until reaching a specified temperature. It takes ca. 5 to 10 minutes. If the chamber temperature is high enough, it decreases the preheating time or preheating is switched off.

- **Deaeration** (Entlüftung):

In all Liquids programs a gravity deaeration is preselected automatically.

In versions B and M (no vacuum available) the deaeration for Instruments and Waste is preselected as a pressure purge cycle. It works with 3 to 5 pressure purges between 190 and 120 kPa absolute pressure (number of pressure purges depends on program type).

In versions V and MV the deaeration for Instruments and Waste programs works with fractionated prevacuum.

- **Heating** (Aufheizen)

While preheating the chamber is filled with steam up to the preset pressure and temperature. In preheating phase a deaeration clock is working in most of the programs.

- **Sterilizing** (Sterilisieren)

While sterilization phase the unit is keeping the set temperature over the sterilization time. In case over lower temperature that set temperature, the timer for the sterilization time is stopping.

- **pressure remove** (Dapfablaß)

The steam is removing from chamber until reaching programmed pressure in chamber

- **cooling** (Kühlen)

This is programmed for liquids only. Depending on the integrated fast cooling options different cooling versions are possible: passiv or active, in active cooling slow, fast or forced is possible.

- **drying** (Trocknung) **(for versions V and MV only)**

Program is drying with vacuum with a programmed drying time. Alternate an intermitting venting and vacuum cycle is possible. The venting function is automatically using the venting air filter.

- **Venting** (Belüften)

The program is using for the venting function the integrated venting air filter automatically. The function works until reaching the programmed air pressure.

- **equalizing** (Ausgleich)

For additional safety the device is waiting a few seconds after reaching the program finish to make sure that no measurement mistake has set the program to finish. Equalizing time depends on program and sterilization goods and can be different.

- **Programs for testing**

The Bowie&Dick-Test is proofing the process for steam penetration of the sterilization good (mainly for textiles or paper wrap). This test is implemented in vacuum option only. The test is normally for medical use only! The test body for this test should be a one usable test package only.

The vacuum test is implemented in vacuum option only. It can be used for testing the leakage rate of the unit. For the normal use it is not necessary to run this test (implemented for service/maintenance).

The test should run if the chamber is cold! The chamber temperature should be not higher than 40°C (than it is impossible to start the test).



If the test result is “Incorrect” the unit should get a service / maintenance! In that case you should not use the device until qualified service stuff has checked the device!

All sterilization cycles are running automatically. The duration of a single cycle depends on the load, kind of deaeration, number of vacuum fractions in fractionated prevacuum and the start conditions (warm or cold), drying time, kind of cooling etc. Even so the type of sterilization goods, and kind of loading the god inside the chamber have a enormous effect on the cycle time. In case of a validation you can define the goods and loads. When ever the same good / load with same program and same parameters is started, the time depends mainly from start temperature. The control unit is automatically adding preheating and deaeration cycles if temperature was to low!

Prog.	Material	Deaeration	Steril. time	Steril. temp.	drying/cooling	Duration [min]
P1 (B/M)	Instruments	Press. purge: 3x 190 kPa / 120 kPa	15 min	134°C	No	41 min
P1 (V/MV)	Instruments	Vacuum + Steam: 2x 35 kPa / 170 kPa	15 min	134°C	5 min	45 min
P2 (B/M)	Instruments	Press. purge: 4x 190 kPa / 120 kPa	20 min	121°C	No	45 min
P2 (V/MV)	Instruments	Vacuum + Steam: 2x 35 kPa / 170 kPa	20 min	121°C	5 min	55 min
P3 (B/M)	Waste	Press. purge: 5x 190 kPa / 120 kPa	20 min	134°C	No	50 min
P3 (V/MV)	Waste	Vacuum + Steam: 2x 35 kPa / 170 kPa	20 min	134°C	No	55 min
P4 (M/MV)	Liquids	Gravitation	20 min	121°C	cooling activ	1:20 h
P4 (B/V)	Liquids	Gravitation	20 min	121°C	cooling passiv	1:50 h
P5	Liquids	Gravitation	20 min	121°C	cooling passiv	1:50 h
P6 – P20	Like P1	Like P1	Like P1	Like P1	Like P1	Like P1
P21 (V,MV)	Bowie&Dick- Test	Vacuum + Steam: 3x 35 kPa / 170 kPa	3:30 min	134°C	3 min	60 min
P22 (V,MV)	Vacuumtest					20 min

IV. Operating the steam sterilizer Laboklav 25

1. List of delivered parts

- Sterilizer Laboklav 25 - 1 Stk.

Inclusive of following equipment:

Bottom sheet - 1 pc.

Documents including user manual, pressure vessel papers (conformity declaration), safety valve calculation, warranty declaration - 1 pc.

Connecting pipe for water supply steam / condensate remove - 1 pc.

Basket acc. to order

2. Installation

• Preparation of the unit

The floor in the room should be waterproof. The sterilizer require foundations (solid bench with load capacity of 100 kg). The necessary food print is 50 cm x 60 cm. Please let a little bit space between the rear side and the wall in the back (approx 5..10 cm).

• Power supply

The steam sterilizer is equipped with a 2,5 m long net supply cable. The device is configured to be connected to an electrical system of 230V AC, 50 Hz, 16 A. For commercial use we recommend to use an additional fault current protection switch.



If the device is connected to a power supply with wrong or without correct ground connection it may endanger the operator of the device by dangerous electrical voltage.



Connecting the device to a power supply with lower capacity than 16 A may cause an over load or heating up the power cable and can cause a fire!

• Water supply

The steam sterilizer needs demineralized or distilled water only! Please refer to Appendix C EN 13060 about water quality. Normal tap water / drinking water is not for use as feed water! See the quality definition in chapter VII Additional Informations. The device is equipped with a build in tank that needs to be filled with approx. 3 Liter distilled / demineralized water. Refilling the tank should be done in the beginning of each working day. The volume of the tank is enough for up to 3-4 cycles.



Attention! Do not overfill the tank! If the maximum level is reached the control unit gives an alarm (if alarm is activated)!

3. Installation and operation

- **Switching on**

After regular installation and connecting to the power supply the device is ready for use. Standing in front of the device you will find the main switch at the right side of the door. Switching on the main switch the display is switched on and shows the software version and the SHP Logo short time. When switched on the device is ready for use.



Do not manipulate the device! If the device is not going on please check the main breakers of the unit (4 – chap.1) and of power supply. If no reason can be found please inform a trained service staff to check the device internally.



After switching on and going into a program (without P12 – vacuum test) the device is preheating the steam generator when lid is closed!

- **Loading the device**

We suggest to use the standard baskets and drum we optionally offer for the special use in Laboklav steam sterilizers. For bench top units we suggest the use of closed loading trays to protect the chamber against to much condensate.



While loading and unloading the chamber please consider the chamber and surface of the device can be hot! Even so the loading goods and loading system parts like baskets! While loading and unloading you are in danger of burning!



Use adequate clothes to be protected against burning like temperature stable isolating gloves etc.

- **Touch panel**

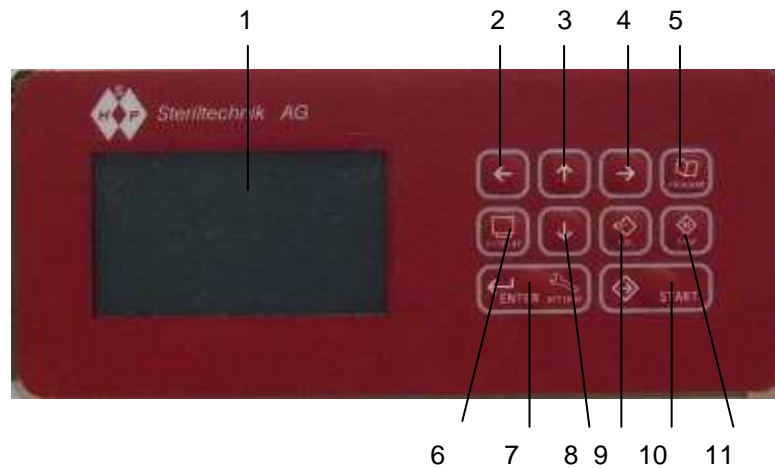

1 Display	displays program parameter, cycle data and error messages
2 Cursor button to left	moves cursor left
3 button up	moves cursor up and changes value at actual cursor position, open door
4 Cursor button right	moves cursor right
5 Program button	for entering the program menu to change the program, by using up and down button the program is chosen and activated by pressing the enter button
6 Display button	changes display from normal program display to display of actual sensor values, information about statistic data and software version
7 Enter button	enters the input data or entry in a menu
8 Cursor button down	moves cursor down and changes value at actual cursor position, close door
9 Escape button	for leaving a menu position after or before changing is valid
10 Start button	starts the actual in display shown program
11 Stopp button	breaks a running program and quits the final signal after finishing a program regular or by manual break Opening of the lid is possible after quitting the program only

• Program change

Activating a program is done by pressing program button (5). It opens the program menu and with the up (3) and down button (8) the right program is chosen by pressing the enter button (7). All programs which are marked with a key symbol needs entering a code before activation:

Enter acces code:

	↵
0 1 2 3 4 5 6 7 8 9 a b c d e f g h i	
j k l m n o p q r s t u v w x y z A B C	
D E F G H I J K L M N O P Q R S T U V W	
X Y Z ! () + - , . / % : ; °	

The cursor buttons navigate the cursor, up and down button changes the value, enter button must be pressed to confirm the code

• 2. Display level

In second display level the actual value of all installed sensors is shown.

The symbols shows the following sensors:

- Tk – chamber temperature,
- Tr – reference temperature,
- Pk – chamber pressure,
- Tg – temperature steam generator,
- Tf – temperature in filter cartridge (Option FA only),
- To – temperature in the steam / condensate outlet,
- Tm – temperature in the outlet of heating / cooling jacket (not in all options)
- Tcj – reference temperature on electronic board.

14:45:00 Mo 4.10.2006	
1. Tk	74.9 °C
2. Trf	79.0 °C
3. Pk	0.0 kPa
4. Tg	127.2 °C
5. Tm1	117.4 °C
6. Tm2	118.4 °C
7. Tpp	24.2 °C
8. Tcj	30.4 °C

• Program start

After activation of a program press the start button and program starts. Depending on the program and the temperature in chamber the device starts directly or starts with preheating to realize standard start conditions.

• STOP button

Press the Stop button to break a program or to quit the finish signal. While a program is running you can break a program, the program is asking if you really want to break the program so have to confirm this. The program is going to the next possible program phase without coming in danger for user or sterilization goods. Breaking a program is a special situation for the device. The device goes automatically in a standard program phase! For liquids does it mean that the unit is switching off the fast cooling function and waits until reaching the removal temperature and removal pressure! So that can mean the program needs longer for finish like without the program break!



Use the program break for emergency break only! The device will try to finish the program regular even it finds an error! So breaking a program is not necessary in each case of error message. Try Escape before breaking the program!

- **Changing program parameters**

To change program parameters press the Enter button. You reach the code menu. Give the code 2000 to the menu and confirm with Enter button. To navigate through the menu use the cursor buttons.

Enter access code:

	↵
0 1 2 3 4 5 6 7 8 9 a b c d e f g h i	
j k l m n o p q r s t u v w x y z A B C	
D E F G H I J K L M N O P Q R S T U V W	
X Y Z ! () + - , . / % : ; °	

If the code was correct you reach the main menu. Depending on the access level defined by the code the main menu shows different submenus.

In the picture you find the maximum main menu, by giving the code 2000 you find the program parameter point only.

Main menu

Program parameters
Time and date
Device configuration
Measuring channels
Controller tests
Non-volatile memory

Enter the point program parameters. Inside the submenu go to the program you want to change.

Parameter P1

Program description
Access control
Common condition
Dearation phase
Heating phase
Sterilization phase

Inside this submenu you can choose the program phase that should be changed directly.



Change Program parameters only if the result gives real advantage! The preprogrammed sterilization cycles are validated for empty chamber and full loaded chamber. For the normal use the 10 preprogrammed cycles should be enough.

When all programs are configured you should run and test the program with empty chamber and full loaded chamber to be sure the program parameters do not make problems in normal cycle run. If there are doubts, you should make a full validation of the program.

4. Sterilization cycle progress

The program cycle is running fully automatically. The display shows the actual program cycle and gives information what is the actual situation in the running program phase.

The successful finish of sterilization cycle will be displayed. In case of an incorrect cycle additionally sounds an acoustic signal.

In the following the typical display are described:

14:45:00 Mo 4.10.2006		
P1	Tk =	74.9 °C
	Pk =	0.0 kPa
	Trf =	79.0 °C
Instruments		

The steam sterilizer is switched on, program P1 is activated but not started. The device is ready for start. If the door is closed, the device is preheating the steam generator automatically.

Dearation: vac.+ steam 2x
 Steril.: 134 °C 00:04:00
 Drying: no

The display shows program no. P1. Here the program type is shown, if special program name was given it will replace the program type. The main program parameters are shown for fast identification of the program cycle. In the picture display shows Program type Instruments, with dearation fractionated revacuum starting with vacuum followed by steam injection 2 times. Sterilization is programmed for 134°C, 4 min. sterilization time. Drying function is not programmed. In the sensor window the main sensor values are shown.

Er 0001 14:45:00 Mo 4.10.2006		
P1	Tk =	74.9 °C
	Pk =	0.0 kPa
	Trf =	79.0 °C
Instruments		
Er 0001		
Door of the sterilizer is open (GS01)		

The program P1 was started but lid was not completely closed. So the device generates an error message. The error message can be cleared by pressing the Escape button if the cause of the error was cleared.

14:45:00 Mo 4.10.2006		
P1	Tk =	74.9 °C
	Pk =	3.0 kPa
	Trf =	79.0 °C
Instruments		
Phase:	PREAHEATING	
Tg= 37.8 °C	Tm1 =	74.9 °C
	Tm2 =	74.9 °C
		50%

The cycle was started regular, the temperature was low so unit starts with preheating. Instead of Tm1 / Tm2 the jacket temperature Tm is shown (only for option with vacuum and / or fast cooling)

14:45:00 Mo 4.10.2006		
P1	Tk =	74.9 °C
	Pk =	42.5 kPa
	Trf =	79.0 °C
Instruments		
Phase:	DEAERATION [1]	
Setpoint =	85.00 kPa	
		50%

The program was started regular and is now in deaeration phase step 1.

14:45:00 Mo 4.10.2006

P1		Tk = 110.0 °C
		Pk = 50.3 kPa
Instruments		Trf = 109.5 °C

Phase: HEATING

Setpoint: 134.0 °C

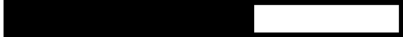

Deaeration has finished, the program is now in heating phase. Setpoint for finish of this phase is reaching the 134°C chamber temperature.

14:45:00 Mo 4.10.2006

P1		Tk = 135.3 °C
		Pk = 316.8 kPa
Instruments		Trf = 134.9 °C

Phase: STERILIZATION

To end= 00:02:00



The sterilizer is in sterilization phase, 2 minutes before finish of this phase.

14:45:00 Mo 4.10.2006

P1		Tk = 110.9 °C
		Pk = 67.9 kPa
Instruments		Trf = 112.7 °C

Phase: PRESSURE REDUCE

Setpoint= 10 kPa



Sterilization phase has finished, now the chamber pressure will be reduced until reaching 10 kPa in chamber.

14:45:00 Mo 4.10.2006

P1		Tk = 102.9 °C
		Pk = -75.8 kPa
Instruments		Trf = 104.7 °C

Phase: DRYING

To end= 0:02:00

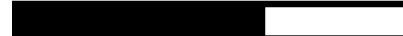

Chamber pressure was reduced lower than 10 kPa, pressure reduce phase has finished, now the device is in drying phase (vacuum pump is running). Drying is not available in units without vacuum pump!

14:45:00 Mo 4.10.2006

P1		Tk = 99.6 °C
		Pk = -6.9 kPa
Instruments		Trf = 98.7 °C

Phase: AERATION



Drying time is over, now the chamber is venting until reaching setpoint.

14:45:00 Mo 4.10.2006

P1		Tk = 99.5 °C
		Pk = -1.6 kPa
Instruments		Trf = 99.7 °C

Phase: EQUALISING

To end= 00:02:00



Venting the chamber has finished. An additional time is running for safety.

14:45:00 Mo 4.10.2006	
P1	Tk = 99.7 °C
	Pk = 0.0 kPa
Instruments	Trf = 99.8 °C
Phase:	END OF CYCLE
Course:	CORRECT

The program cycle has finished successfully. The sterilizer gives the result as correct cycle. Now the program needs to be quit by pressing the Stop button. Tehn the lid can be opened and the sterilization good can be removed from chamber.

In case of a not successful or broken program the sterilizer shows the following message:

14:45:00 Mo 4.10.2006	
P1	Tk = 74.9 °C
	Pk = 0.0 kPa
Instruments	Trf = 79.0 °C
Phase:	END OF CYCLE
Interrupted by operator	
Course:	INCORRECT

Before regular end of cycle a break was initialized, may be by hand or automatically. In case of automatic break an error message is additionally shown.

5. Error handling

The following simple errors will not influence a program by breaking and are not real mistakes in process control. The errors make it impossible to start a program, the reason why it was generated needs to be removed before next start.

Er 0001	14:45:00 Mo 4.10.2006
P1	Tk = 74.9 °C
	Pk = 0.0 kPa
Instruments	Trf = 79.0 °C
Er 0001	
Door of the sterilizer is open (GS01)	

Er 0002	14:45:00 Mo 4.10.2006
P1	Tk = 74.9 °C
	Pk = 0.0 kPa
Instruments	Trf = 79.0 °C
Er 0002	
Too low water level in feed water tank (LLS03)	

Er 0052	14:45:00 Mo 4.10.2006
P1	Tk = 74.9 °C
	Pk = 0.0 kPa
Instruments	Trf = 79.0 °C
Er 0052	
Highest water level in feed water tank (LHS03)	

(correct Error number see Error list)

6. Operating the sterilizer – general information

- **Preheating the chamber**

After switching on the unit is in a wait modus. After activating a program the unit changes into a standby modus and activates automatic preheating function. This function is automatically preheating the steam generator if the door is closed. Jacket preheating starts in special programs only if it is activated.

If the door is open, the automatic preheating is disabled!

- **Preparation of sterilization goods**

Solid sterilization goods should be cleaned before sterilizing. Cleaning is a basic part of sterilization process. It reduces the numbers of microorganism on the surface. The sterilization is not a cleaning process! Microorganism will be killed or deactivated but the rest of material that the microorganism consists of will be on the surface after the sterilization has finished! Often these particles act as pyrogens!

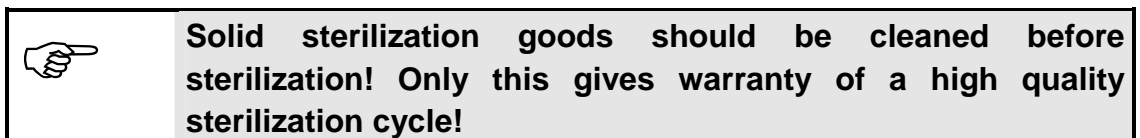

For wrapping the sterilization goods the wrapping material should be convenient to use as wrapping material! The wrapping should be closed over the complete cycle to protect the goods against recontamination after sterilization has finished. For waste material in a waste bag the opposite is valid. Waste bags should be opened or should open under vacuum! This is necessary to make sure the steam comes in direct contact with sterilization good. If there are doubts that the sterilization process runs without complications it should be validated!

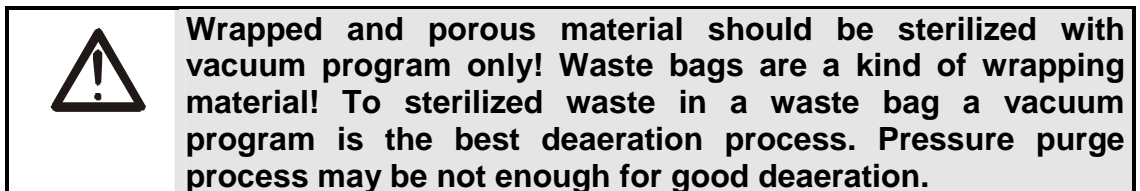

Especially when sterilizing wrapped goods it is necessary to keep the load in the same kind it was validated. The single packages should not lay inside to close to the next. Deaeration and drying function depend on the kind of loading! If the steam can not reach the good evenly spread, the heating power will create temperature differences!

Heavy good should lay on the ground of the chamber, lighter goods should lay upstairs. In each program cycle the loads should be from the same type. The deaeration type should respect the most heavy and complicate load! A mixture of solid and liquid loads should be avoided.

The maximum loads are defined in chap. 1 technical data. Please refer to this chapter to see the maximum load of each type of load!



Attention please while using hot liquids! While contact with hot liquids with temperature of more than 60°C it can burn the skin!



Attention please while handling closed waste bags! If the unit is not equipped with vacuum the waste needs to be opened while loaded into the chamber. While opening the waste bag bio aerosols will come free and may infect the operator! Operate the device in the right protection clothes only! Protect your skin, your face especially eyes, nose, mouth!

- **Cancellation of program cycle**

Each program is able to be broken manually by operator by pressing the STOP button. The program asks if cancellation is really necessary before breaking. After breaking the program has different possibilities to react. The reaction depends on the situation and the program in that the break shall happen. Normally the program is going into the pressure reduce phase for solid goods or into the cooling phase for liquids. The program is only using the parameters for standard programs of this sterilization good! Especially if liquids was chosen, the program break cause a very long waiting time until unlocking the lid! In or after the cooling phase of liquid programs a program cancellation is not possible!

In case of a liquid program the activated thermo lock can not disabled by using the program cancellation function!



In case of a program cancellation before regular finish of sterilization phase the sterilization goods are not sterile! The sterilization needs to be repeated!

In case of a break while drying is running the sterilization goods may be wet! The sterilization goods are not ready for storing process! Recontamination is possible in very short time! The chamber should be dried manually before next start.

- **Draining the condensate**

To remove the condensate the unit is equipped with an outlet to connect to a drainage system. If the unit is connected with cold water supply the program is automatically protecting the condensate drain against over heating by direct draining with hot steam.

- **Documentation of sterilization cycle**

The device is prepared for 2 different kinds of cycle documentation. The first is the connection to a standard IBM compatible PC via RS485 interface in the back of the unit. For read out of data a special interface transformer is necessary (RS 485 to USB adapter). Additionally you need to install documentation software Dokumentator.

The second possibility is to built in a standard needle printer for 40 characters per line with serial interface (CBM 910). The sterilizer has a built in memory with up to 4 MB and is automatically storing the data of each cycle until memory is full. Then start program over writing the oldest data. Data readout by one of the 2 possibilities is possible later on.

The parallel use of the 2 documentation possibilities is available under special conditions too.

The DOKUMENTATOR software has different levels of functionality. In basic module the following functions are available:

- Documentation of running cycle;
- Readout of data from memory;
- Display of different analog channels;
- Printout of the data as graphic and table;
- Display and printout of archive data;
- Protection of the data against changing;

In following picture you can see the main window of the Dokumentator software.



The printer CBM-910II CITIZEN is a dot matrix printer. It is available as built in version. An interface for external connection is not available. With the printer it is possible to printout all relevant process data while the process is running. To a later time it is possible too.



The printer should be loaded with enough paper. If the paper role is at the end the printer stops automatically.

V. Maintenance

The sterilizer should get regular cleaning, maintenance and service. Some parts are regular to be changed completely to protect the device against damage or mistakes in sterilization cycle. The simple cleaning and maintenance activities can be done by the operator without problems.

Special services can be done by specially trained service staff only! All inspection activities acc. to pressure vessel regulations / local regulations for pressure vessels and electrical installations need special trained service staff! We recommend to order one regular safety inspection per year and to connect this with a regular maintenance for the vessel, pressure parts and electrical installations. Your distributor is authorized to tell recommend a trained service partner.



We recommend to use a device book that helps to document all cleaning, maintenance and service repair activities at the device.



Maintenance or repair activities that need to open the housing are not allowed to be done by untrained personal stuff!



For maintenance or repair activities that need to open the housing the electrical power supply must be disconnected! Inside the housing dangerous electrical voltage can kill or hurt!



After work at electrical installations some electrical test are necessary to do. Please respect the local rules and regulations!

- **Regular cleaning, maintenance and service activities**

activity	Recommended time					notes
	dayl y	wee kly	Mon thly	Half year	year ly	
Cleaning the surface of chamber ring	X	X	X	X	X	
Cleaning chamber inside	X	X	X	X	X	Especially after over boiling of sugar or agar solution
Cleaning baskets		X	X	X	X	
Cleaning trays and bottom sheets		X	X	X	X	
Cleaning lid seal and check for damages	X	X	X	X	X	Change lid seal if damaged (SERVICE)
Cleaning the device outside			X			
Check the safety valve					X	
Check the in/out connections			X	X	X	
Change the ventil air filter			X	X	X	
Function test for the valves					X	SERVICE
Cleaning the tank					X	SERVICE
Functional test of vacuum pump					X	SERVICE
Check program parameters				X	X	
Check for lid / door adjustment					X	SERVICE
Electrical test (BGVA 2/4)					X	SERVICE
Attention please! Opening the unit is allowed for authorized and trained service stuff only!						

- **Cleaning**



Before starting with cleaning the device please disconnect the unit from power supply completely! Cleaning should be done if the unit was cooling down only! Danger if the chamber is hot!

- **cleaning the surface of chamber ring** – Clean that area regular! That area is necessary for closing and sealing the chamber completely. Use a wet towel or textile cotton material for cleaning. In case of hard waste in the surface you can use the hard side of house hold eraser. Do not use aggressive chemicals or organic solutions like alcohol, benzine or acetone.



Do not use aggressive chemicals or rough cleaning materials for cleaning the metal surface!

- **Cleaning the chamber inside** – for cleaning the chamber use a wet and soft towel from cotton material. Special cleaning material or chemicals are not necessary. Do not use aggressive or organic chemical for cleaning! Chemicals can damage the sealing or sensors!



The rest of chemicals or cleaning materials will be brought forward to the sterilization goods of next sterilization cycle! Do not use aggressive or organic chemicals for cleaning!

- **Cleaning the accessories** – Clean the baskets etc. with wet towel or under running water.

- **Cleaning the housing** – The housing needs to be cleaned by wet towel or light oil. Special cleaning chemicals like used in house hold can be used.

- **Check of the safety valve(s)**

The safety valve needs to be checked once per year. This should be done by a specially trained service staff. Other safety checks are necessary so we recommend to make one safety check together with the yearly maintenance check by a trained service engineer. While testing the function of the safety valve steam is leaving the safety valve.



Attention please! While steam is leaving the safety valve the valve is getting very hot in a very short time! Make sure that your human skin is not coming in contact with the steam! Contact with the steam can burn your skin!



If the valve is not closing completely after testing it needs to be changed! If there are doubts about the regular functionality of the tested valve it needs to be changed!

- **Changing the venting air filter**

Wear and tear of the venting air filter depends on the number of cycles and the quality of the environment. We recommend to change the filter after 100 cycles or once per month.

- **Liste der Verbrauchsmaterialien**

Ersatzteil	Zeichnungsnr.	Artikelnr.
Venting air filter; 0.3 µm / 99.5% – φ 50 (1/8" NPT)		40-0719-142-014
Door seal	Laboklav 25	

VI. Description of safety devices

The steam sterilizer is equipped with different safety devices. The safety devices protect the user against injury and safe the sterilization process. Mechanical and electronic safety devices are build in and realize in sum a safety concept with different safety functions.

- **protection against over pressure** – If control board is measuring a chamber pressure of more than 345 kPa absolute pressure (2,45 bar relative pressure) an alarm is generated (including error message) and the heating function is switched of. The heating function can be switched on manually again by pressing Escape button. So the program is not broken. With 360 kPa absolute pressure another error message is generated that is breaking the program automatically. With 2.8 bar relative pressure the safety valve is opening and chamber pressure is reduced mechanically! The steam is blowing into the housing contact with the steam is not very dangerous because it is saturated after blowing out.

Attention: To check the safety valve a special program can be implemented that is bridging the safety functions of over pressure protection. This program will be implemented on special order by the customer only! Blowing off the safety valve in the condition that the housing is not opened can damage the electronic board!

- **Protection against opening the chamber while over pressure is inside** – the device has a built in thermo locking function. The device opens the thermo lock when pressure is low only. The pressure is checked by pressure sensor and an additional pressure switch that detects normal pressure. The opening mechanism is calculated to open when chamber pressure is low. These 3 safety functions give good protection against opening while pressure in chamber is high.
- **Protection against opening the chamber while temperature of liquids is too high** – One part of the thermo locking system is the measurement of the temperature inside liquids by the reference sensor. The device is unlocking the lid in liquid programs when temperature is lower than programmed removing temperature is reached only. The flask where the reference sensor is positioned should be from the same size, form and filled with same volume of the largest single volume of the sterilization goods.
- **Protection against steam out coming from chamber** – steam production is switched off immediately if the lid is opened. After program finish the preheating of steam generator is switched off so steam out coming from steam inlet should be not possible. Preheating is switched on again after new program change or entering the same program again.
- **Protection against over heating the steam generator** – the steam generator is protected against over heating by 2 independent over temperature switches. One of them is self resetting when temperature is low again, the second one needs to be reset manually by authorized service stuff. Over heating protection switches break the program.
- **Protection against over heating the chamber** – The chamber is not directly heated so it can reach maximum the steam temperature that is limited by the pressure.

VII. Additional Information

- **Definition of feed water quality**

Acc. to **EN 285** – “Steam sterilizers”, app. B / EN 13060 – small size steam sterilizers App. C

	Feed water	Condensate
Residual dry matter	≤ 10 mg/l	≤ 1.0 mg/kg
Silica oxide, SiO ₂	≤ 1 mg/l	≤ 0.1 mg/kg
Iron	≤ 0.2 mg/l	≤ 0.1 mg/kg
Cadmium	≤ 0.005 mg/l	≤ 0.005 mg/kg
Lead	≤ 0.05 mg/l	≤ 0.05 mg/kg
Other heavy metals, except for iron, cadmium, lead	≤ 0.1 mg/l	≤ 0.1 mg/kg
Chlorines	≤ 2 mg/l	≤ 0.1 mg/kg
Phosphates	≤ 0.5 mg/l	≤ 0.1 mg/kg
Conductivity (at 20°C)	≤ 15 µS/cm	≤ 3 µS/cm
pH	5 do 7	5 do 7
Colour	Colourless, clean, no deposit	Colourless, clean, no deposit
Hardness	≤ 0.02 mmol/l	≤ 0.02 mmol/l
NOTE 1: Using water of contamination greater than specified above for steam generation, can considerably reduce the sterilizer life and void the manufacturer's warranty.		
NOTE 2: The condensate should be derived out of the steam collected during sterilizing cycle with the chamber empty.		

Tests for conformance are performed with commonly used analytic methods.

- **Service and maintenance**

If there are any problems in operating the sterilizer please contact your distributor first. The distributor knows the address of the next authorized service company or is able to solve your problem directly

Manufacturer Germany	SHP Steriltechnik AG, Schloss Detzel 1 39345 Detzel Schloss / Satuelle	
Fax	+49 39058 97 62- 22	08:00 bis 17:00 Mo. – Fr.
Tel.	+49 39058 97 62- 0	08:00 bis 17:00 Mo. – Fr.
Mobil	+49 177 6269880	24 h
Email	info@shp-steriltechnik.de	08:00 bis 17:00 Mo. – Fr.

You can also contact the local importer/distributor as per your invoice or the mentioned on the sticker on the instrument.

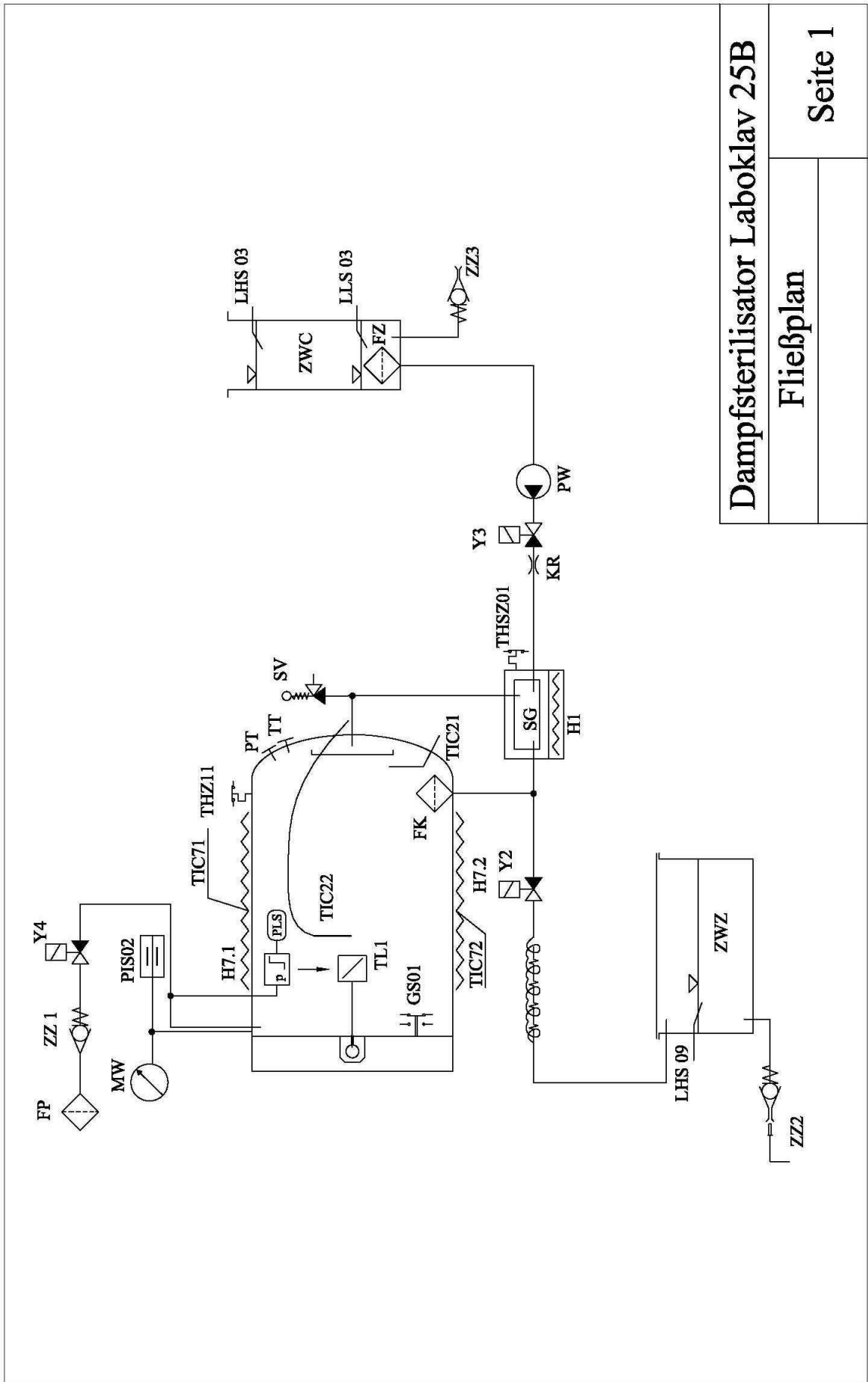

Dampfsterilisator Laboklav 25B

Fließplan

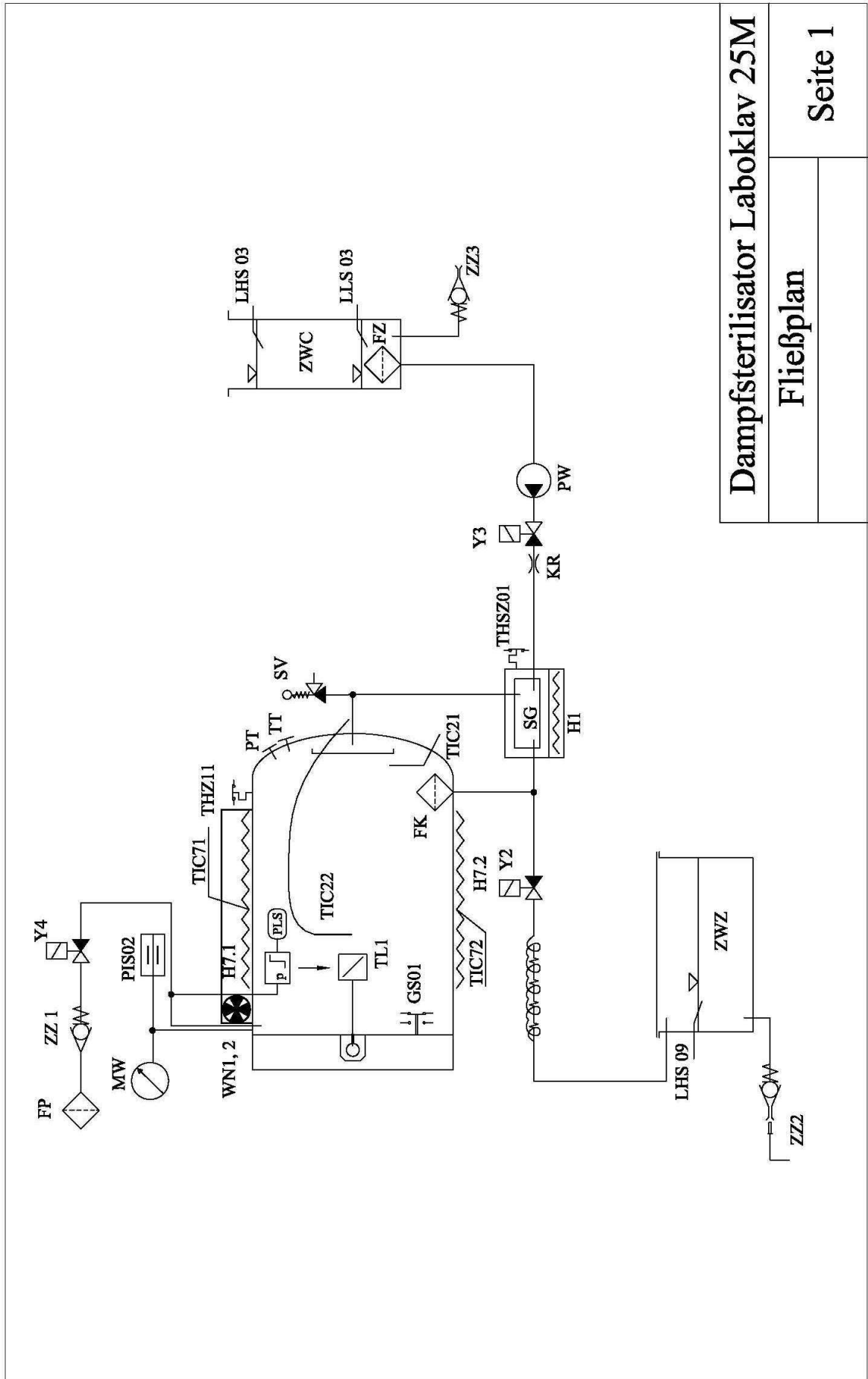

Dampfsterilisator Laboklav 25M
Fließplan
Seite 1

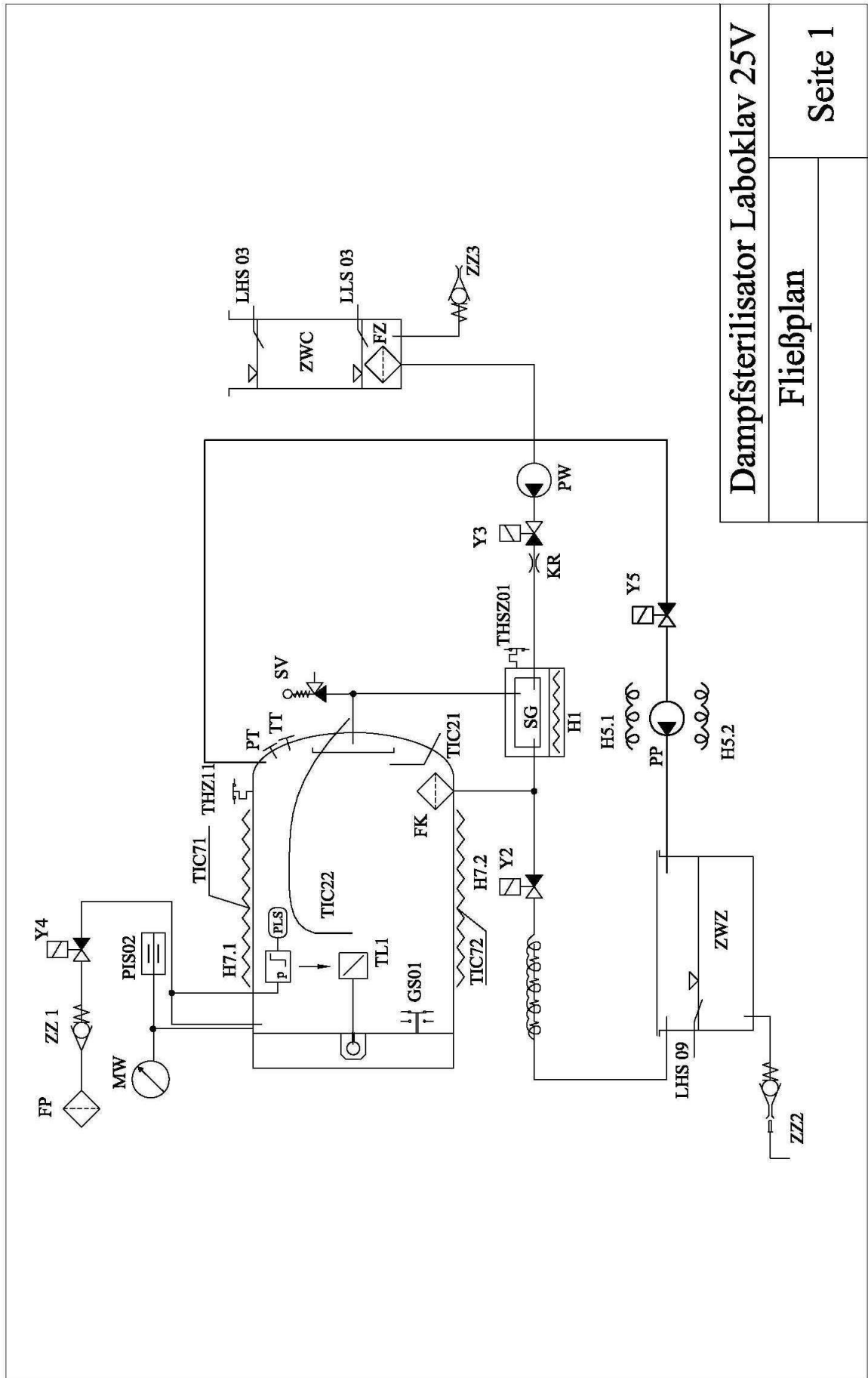

Dampfsterilisator Laboklav 25V
Fließplan
Seite 1

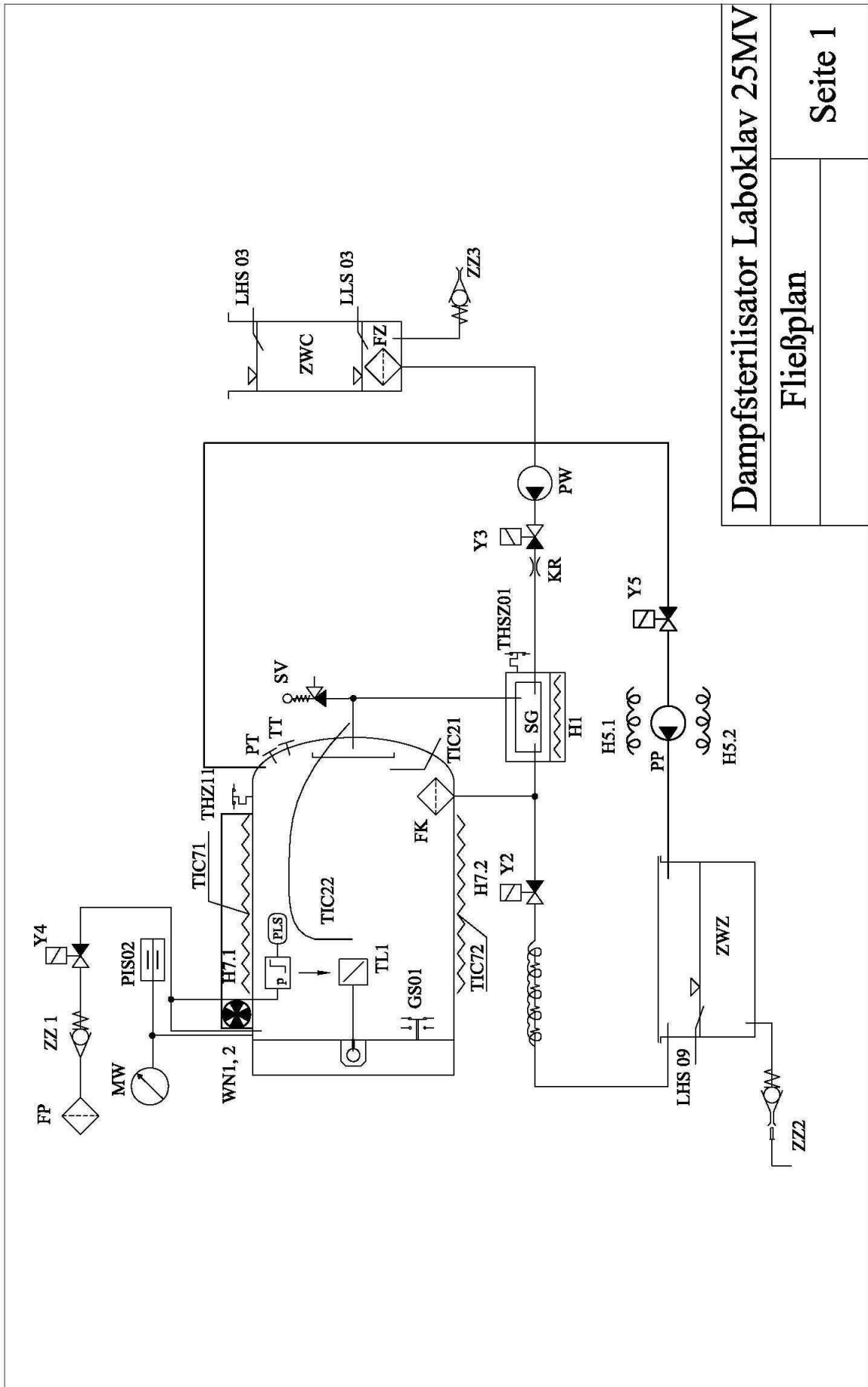

Dampfsterilisator Laboklav 25MV
Fließplan

Capture for Flow chart of steam sterilizer Laboklav 25

FK	Sieve in chamber outlet (not installed anymore)
FP	Venting filter
FZ	Sieve in feed water tank (not installed anymore)
GS01 (05)	Position switch for door position
H1	Heating element for steam generator
H5.1	Heating element for head of vacuum pump
H5.2	Heating element for head of vacuum pump
H7.1	Heating element for chamber
H7.2	Heating element for chamber
KR	Not installed
LHS03	Water level sensor feed water tank „full“
LLS03	Water level sensor feed water tank „empty“
LHS09	Water level sensor condensate tank „full“
MW	Manometer (not installed anymore)
PIS 02	Pressure sensor chamber pressure Pk
PLS	Pressure switch low pressure in chamber
PP	Vacuum pump
PT	Validation duct pressure sensor
PW	Water pump
SV	Safety valve
SG	Steam generator
TT	Validation duct temperature
THSZ01	Over temperature switch steam generator
THZ11	Over temperature switch chamber heater
TIC21	Temperature sensor Tk
TIC22	Temperature sensor Tref
TIC71	Temperature sensor jacket heater up
TIC72	Temperature sensor jacket heater down
TL1	Thermo lock not installed anymore (elektronik function motor drive of locking mechanism)
WN 1, WN 2	Fan for fast cooling option (only one installed)
Y2	Steam outlet valve
Y3	Water injection valve
Y4	Venting valve
Y5	Vacuum valve
ZWC	Feed water tank
ZWZ	Condensate tank
ZZ 1	Back pressure valve venting function
ZZ 2	Connector condensate tank remove
ZZ 3	Connector feed water tank remove