

# Manual

## Vibratory Sieve Shaker AS 200 control

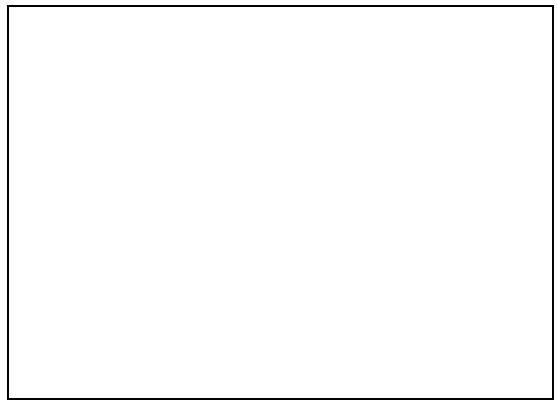

Translation



**Copyright**

© Copyright by  
Retsch GmbH  
Retsch-Allee 1-5  
42781 Haan  
Germany

## Table of Contents

<b>1</b>	<b>Notes on the Manual .....</b>	<b>6</b>
1.1	Disclaimer .....	6
1.2	Copyright.....	6
1.3	Explanations of the Safety Instructions .....	7
1.4	General Safety Instructions .....	8
1.5	Repairs.....	9
<b>2</b>	<b>Confirmation Form for the Managing Operator.....</b>	<b>10</b>
<b>3</b>	<b>Technical Data .....</b>	<b>11</b>
3.1	Degree of Protection.....	11
3.2	Emissions.....	11
3.3	Electromagnetic Compatibility (EMC).....	12
3.4	Rated Power .....	12
3.5	Dimensions and Weight.....	12
3.6	Required Floor Space.....	12
3.7	Receptacle Volume.....	12
3.8	Feed Grain Size.....	13
3.9	Payload.....	13
3.10	Suitable Sieve Diameters .....	13
<b>4</b>	<b>Packaging, Transport and Installation .....</b>	<b>14</b>
4.1	Packaging .....	14
4.2	Transport.....	14
4.3	Temperature Fluctuations and Condensation .....	14
4.4	Conditions for the Installation Site .....	15
4.5	Electrical Connection .....	16
4.6	Type Plate Description.....	16
4.7	Removing the Transportation Lock.....	17
<b>5</b>	<b>First Commissioning.....</b>	<b>19</b>
5.1	Sieve Clamping Unit "economy" and "standard" .....	20
5.2	Sieve Clamping Unit "comfort".....	20
<b>6</b>	<b>Operating the Device .....</b>	<b>23</b>
6.1	Use of the Device for the Intended Purpose.....	23
6.2	Principle of Operation .....	24
6.3	Views of the Instrument .....	25
6.3.1	Front.....	25
6.3.2	Back .....	26
6.4	Switching On / Off.....	27
6.5	Selection of the Test Sieves .....	27
6.6	Performing a Sieving .....	27
<b>7</b>	<b>Controlling the Device .....</b>	<b>29</b>
7.1	Operating Controls, Displays and Functions .....	29
7.2	Start Process .....	29
7.3	Stop Process .....	30
7.4	Pause Process.....	30
7.5	Amplitude.....	30
7.5.1	Amplitudes in Dependence on the Load.....	31
7.6	Time .....	32
7.7	Optimisation of Time and Amplitude.....	32
7.8	Interval .....	33
7.8.1	Interval Time .....	34
7.9	Programme Mode .....	34
7.9.1	Select a Programme .....	34
7.9.2	Edit a Programme .....	34

7.9.3	Save a Programme .....	35
7.10	Signal Tone .....	35
7.11	Operating Hours .....	35
7.12	Software Version .....	35
7.13	Date .....	35
<b>8</b>	<b>Wet Sieving .....</b>	<b>37</b>
8.1	Installing the Slash Protection .....	37
8.2	Performing the Wet Sieving .....	38
<b>9</b>	<b>EasySieve® .....</b>	<b>41</b>
<b>10</b>	<b>Error Messages and Information Notes .....</b>	<b>42</b>
10.1	Error Messages .....	42
10.2	Information Notes .....	42
<b>11</b>	<b>Return for Service and Maintenance .....</b>	<b>44</b>
<b>12</b>	<b>Cleaning, Wear and Maintenance .....</b>	<b>45</b>
12.1	Cleaning .....	45
12.1.1	Cleaning of Test Sieves .....	45
12.1.1.1	Cleaning of Test Sieves with Mesh Sizes > 500 µm .....	45
12.1.1.2	Cleaning of Test Sieves with Mesh Sizes < 500 µm .....	45
12.1.1.3	Drying of Test Sieves .....	46
12.2	Wear .....	46
12.3	Maintenance .....	46
12.3.1	Replacing the Fuses .....	47
<b>13</b>	<b>Accessories .....</b>	<b>48</b>
13.1	Test Sieves .....	48
13.1.1	Certificate .....	48
13.1.2	Calibration Service .....	49
13.2	Sieving Aids .....	49
13.3	Add-on Weight .....	50
<b>14</b>	<b>Disposal .....</b>	<b>51</b>
<b>15</b>	<b>Index .....</b>	<b>52</b>



# 1 Notes on the Manual

**Dear user,**

please read the following manual referring to this device carefully before starting any installation, commissioning and operation.

This manual is a technical guide on how to operate the device safely and it contains all the information required for the areas specified in the table of contents. This technical documentation is a reference and instruction manual. The individual chapters are complete in themselves. Familiarity (of the respective target groups defined per area) with the relevant chapters is a precondition for the safe and appropriate use of the device.

This manual does not contain any repair instructions. In case of any obscurities or questions with regards to this document or the device, as well as if faults arise or repairs are necessary, please contact your supplier or get in touch with Retsch GmbH directly.

Application-technical information relating to samples to be processed are not or only to a certain extend included. However, more information thereof can be found in the internet on the webpage of the respective device on the Retsch GmbH homepage (<http://www.retsch.com>).

**Revision status:**

This document revision 0006 refers to the manual "Vibratory Sieve Shaker AS 200 control" in compliance with the Directive of Machinery 2006/42/EC.

## 1.1 Disclaimer

This document has been prepared with due care. Technical and software based modifications are reserved. No liability is assumed for data loss, personnel injury or damage to the device which results from the failure to observe the instructions and/or warnings in this document.

## 1.2 Copyright

This document or parts of it or its content may not be reproduced, distributed, edited or copied in any form without prior written permission of Retsch GmbH. Damage claims shall be asserted in the case of infringements.

### 1.3 Explanations of the Safety Instructions

In this document the following **signs and symbols** are being used:

①	Reference to a recommendation and/or an important information
→	Reference to a chapter, table or figure
⇒	Action instruction
Name	Software menu function
[Name]	Software button
<Name>	Software checkbox

In this document the following **safety instructions** warn of possible dangers and damages:

**DANGER**

D1.0000

**Type of danger / personal injury**  
Source of danger

- Possible consequences if the dangers are not observed.
- **Instructions and information on how the dangers are to be avoided.**

**Life-threatening personal injuries** may result from disrespecting the safety instruction for danger. There exists a **very high risk** of hazard of life or permanent injury to personnel. Additionally, in continuous text or action instructions the signal word  **DANGER** is used.

**WARNING**

W1.0000

**Type of danger / personal injury**  
Source of danger

- Possible consequences if the dangers are not observed.
- **Instructions and information on how the dangers are to be avoided.**

**Serious personal injuries** may result from disrespecting the warning notice. There exists an **elevated risk** of an accident or severe or possibly fatal injury to personnel. Additionally, in continuous text or action instructions the signal word  **WARNING** is used.

**CAUTION**

C1.0000

**Type of danger / personal injury**  
Source of danger

- Possible consequences if the dangers are not observed.
- **Instructions and information on how the dangers are to be avoided.**

**Moderate or mild personal injuries** may result from disrespecting the safety instruction for caution. There exists a medium or low risk of an accident or injury to personnel. Additionally, in continuous text or action instructions the signal word  **CAUTION** is used.

**NOTICE**

N1.0000

**Type of property damage**

Source of property damage

- Possible consequences if the notices are not observed.
- **Instructions and information on how the property damages are to be avoided.**

**Property damages** may result from disrespecting the notice. However, there exists no risk of an injury to personnel. Additionally, in continuous text or action instructions the signal word **NOTICE** is used.

**1.4 General Safety Instructions**

**⚠ CAUTION**

C2.0002

**Read the manual**

Non-observance of the manual

- The non-observance of this manual can result in personal injuries.
- **Read the manual before using the device.**



**Target group:**

All persons concerned with this device in any form.

This device is a modern, high performance product from Retsch GmbH and complies with the state of the art. Operational safety is given if the device is handled for the intended purpose and attention is given to this technical documentation.

**Safety manager:**

The managing operator himself must ensure that the people entrusted with working on the device...

- have noted and understood all the regulations regarding safety,
- are familiar before starting work with all the operating instructions and specifications for the target group relevant to their work,
- have unrestricted and free access to the technical documentation of this device,
- are familiar before starting work with the safe handling of the device and its use for its intended purpose either by verbal instructions from a competent person and/or by means of this technical documentation.

**⚠ CAUTION** Improper operation can result in personal injuries and material damage. The managing operator himself is responsible for his own safety and that of his employees. The managing operator himself is responsible that no unauthorised person has access to the device.

**⚠ CAUTION** Persons who are under the influence of intoxicating substances (pharmaceuticals, drugs, alcohol), fatigue or health disorders must not operate the device.



**CAUTION**

C3.0015

**Changes to the device**

Improper modifications

- Changes to the device can lead to personal injuries.
- **Do not make any modification to the device.**
- **Use spare parts and accessories that have been approved by Retsch GmbH exclusively.**

**NOTICE**

N2.0012

**Changes to the device**

Improper modifications

- The conformity declared by Retsch GmbH with the European Directives will lose its validity.
- Any warranty claims will be terminated.
- **Do not make any modification to the device.**
- **Use spare parts and accessories that have been approved by Retsch GmbH exclusively.**



## 1.5 Repairs

This manual does not contain any repair instructions. For safety reasons, repairs may only be carried out by Retsch GmbH or an authorised representative or by qualified service technicians.

**In case of repair, please inform...**

- ...the Retsch GmbH representative in your country,
- ...your supplier, or
- ...Retsch GmbH directly.

**Service address:**

## 2 Confirmation Form for the Managing Operator

This manual contains essential instructions for operating and maintaining the device which must be strictly observed. It is essential that they be read by the user and by the qualified staff responsible for the device before the device is commissioned. This manual must be available and accessible at the place of use at all times.

The user of the device herewith confirms to the managing operator (owner) that he has received sufficient instructions about the operation and maintenance of the system. The user has received the manual, has read and taken note of its contents and consequently has all the information required for safe operation and is sufficiently familiar with the device.

The managing operator should for legal protection have the user confirm the instruction about the operation of the device.

I have read and taken note of the contents of all chapters in this manual as well as all safety instructions and warnings.

**User**

Surname, first name (block letters)

Position in the company

Place, date and signature

**Managing operator or service technician**

Surname, first name (block letters)

Position in the company

Place, date and signature

### 3 Technical Data

#### 3.1 Degree of Protection

- IP54 (IP20 in the area of the sieve carrier passage)

#### 3.2 Emissions

**⚠ CAUTION**

C4.0011

**Possibility of acoustic signals not being heard**

Loud sieving noises

- Possible acoustic alarms and voice communication might not be heard.
- **Consider the volume of the sieving noise in relation to other acoustic signals in the work environment. Additional visual signals may be used.**

**⚠ CAUTION**

C5.0017

**Hearing damage**

A high sound level may be generated depending on the type of material, the number of sieves, the sieving aid used, the amplitude set and the duration of the sieving



- Excessive noise in terms of level and duration can cause impairments or permanent damage to hearing.
- **Ensure suitable noise protection measures are taken or wear ear protection.**

**Sound parameters:**

The sound parameters are also influenced by the set amplitude, the number of test sieves and the properties of the sample material.

Example 1:

Number of test sieves:	5
Amplitude:	1.5 mm
Feed material:	Quartz sand (< 1 mm)
Sieve clamping unit:	"comfort"

At these operating conditions, the workplace related equivalent continuous sound level  $L_{eq} = 51.2 \text{ dB(A)}$ .

Example 2:

Number of test sieves:	5
Amplitude:	3 mm
Feed material:	Quartz sand (< 1 mm)
Sieve clamping unit:	"comfort"

At these operating conditions, the workplace related equivalent continuous sound level  $L_{eq} = 61.6 \text{ dB(A)}$ .

### 3.3 Electromagnetic Compatibility (EMC)

- EMC class according to DIN EN 55011: A

Strong electromagnetic interference fields, such as high-power radio transmitters, can have an adverse influence on the amplitude control of the AS 200 control. Once the source of the interference is eliminated, the AS 200 control will return to normal operation by itself.

### 3.4 Rated Power

~ 460 W (VA)

### 3.5 Dimensions and Weight

- Height without sieve clamping unit: 212 mm
- Height with sieve clamping unit: 842 mm
- Height with long sieve clamping unit: 951 mm
- Width: 417 mm
- Width with "comfort" clamping unit: 448 mm
- Depth: 384 mm
- Weight without sieve stack, without clamping unit: ~ 35 kg

### 3.6 Required Floor Space

#### CAUTION

C6.0047

#### Falling down of the device

Incorrect positioning or insufficient working space

- Due to its weight, the device can inflict personal injury if it falls down.
- **The device must only be operated on a sufficiently large, strong and stable workplace.**
- **All feet of the device must be positioned securely.**

- Width of the base: 450 mm
- Depth of the base: 450 mm
- No safety clearances required

#### Location requirements:

The device must be placed on a vibration-free, plane, stable and free surface to avoid transmission of vibrations. A level base ensures the uniform distribution of the sample over the sieve mesh fabric, as well as the stability of the device.

### 3.7 Receptacle Volume

The maximum receptacle volume (the maximum feed quantity) depends on various factors such as number and aperture size of the test sieves, maximum grain size and width of distribution of the sample material.

Examples for the maximum feed quantity according to DIN 66165 for test sieves of 200 mm in diameter are listed in the following table:

Mesh size	Max. feed quantity	Max. permitted oversize material according to DIN 66165
25 µm	14 cm <sup>3</sup>	7 cm <sup>3</sup>
45 µm	20 cm <sup>3</sup>	10 cm <sup>3</sup>
63 µm	26 cm <sup>3</sup>	13 cm <sup>3</sup>
125 µm	38 cm <sup>3</sup>	19 cm <sup>3</sup>
250 µm	58 cm <sup>3</sup>	29 cm <sup>3</sup>
500 µm	88 cm <sup>3</sup>	44 cm <sup>3</sup>
1 mm	126 cm <sup>3</sup>	63 cm <sup>3</sup>
2 mm	220 cm <sup>3</sup>	110 cm <sup>3</sup>
4 mm	346 cm <sup>3</sup>	173 cm <sup>3</sup>
8 mm	566 cm <sup>3</sup>	283 cm <sup>3</sup>

### 3.8 Feed Grain Size

Traditional dry sieving is performed in the particle size range of 40 µm to 125 mm. By means of sieving aids or with wet sieving the measurement range can be extended to 20 µm. The maximum feed grain size depends on the sample material, the number and aperture size of the test sieves and the type of the sieving machine.

Examples for the maximum feed grain size according to DIN 66165 are listed in the following table:

Mesh size	Max. feed grain size according to DIN 66165	Mesh size	Max. feed grain size according to DIN 66165
22 µm	710 µm	4 mm	25 mm
45 µm	1 mm	8 mm	45 mm
63 µm	1.4 mm	16 mm	71 mm
125 µm	2.5 mm	22.4 mm	90 mm
250 µm	4 mm	45 mm	150 mm
500 µm	6 mm	63 mm	180 mm
1 mm	10 mm	90 mm	230 mm
2 mm	16 mm	125 mm	300 mm

The Vibratory Sieve Shaker AS 200 control is designed for the measurement range of 20 µm to 25 mm.

### 3.9 Payload

- Maximum sample quantity: 3 kg
- Maximum sieve stack weight: 6 kg
- Maximum payload: 9 kg (sample material plus test sieves)
- Maximum sieve stack height: 620 mm
- Maximum number of fractions: 11 (height of test sieves and collecting pan: 50 mm (2")) / 23 (height of test sieves and collecting pan: 25 mm (1"))

### 3.10 Suitable Sieve Diameters

- Suitable sieve diameters: 100 mm / 150 mm / 200 mm / 203 mm (8")

## 4 Packaging, Transport and Installation

### 4.1 Packaging

The packaging has been adapted to the mode of transport. It complies with the generally applicable packaging guidelines.

#### NOTICE

N3.0001

##### Storage of the packaging

- In the event of a complaint or return, the warranty claim may be endangered if the packaging is inadequate or the device has not been secured correctly.
- **Keep the packaging for the duration of the warranty period.**

### 4.2 Transport

#### NOTICE

N4.0017

##### Transport

- Mechanical or electronic components may be damaged.
- **The device may not be knocked, shaken or thrown during transport.**

#### NOTICE

N5.0014

##### Complaints

Incomplete delivery or transport damage

- The forwarding agent and Retsch GmbH must be notified immediately in the event of transport damage. It is otherwise possible that subsequent complaints will not be recognised.
- **Please check the delivery on receipt of the device for its completeness and intactness.**
- **Notify your forwarding agent and Retsch GmbH within 24 hours.**

### 4.3 Temperature Fluctuations and Condensation

#### NOTICE

N6.0016

##### Temperature fluctuations

The device may be subject to strong temperature fluctuations during transport (e.g. aircraft transport)

- The resultant condensed water may damage electronic components.
- **Wait before commissioning until the device has been acclimatised.**

##### Temporary storage:

Also in case of an interim storage the device must be stored dry and within the specified ambient temperature range.

## 4.4 Conditions for the Installation Site

- Installation height: max. 2 000 m above sea level
- Ambient temperature: 5 °C – 40 °C

### NOTICE

N7.0021

#### Ambient temperature

Temperatures outside the permitted range

- Electronic and mechanical components may be damaged.
- The performance data alter to an unknown extent.
- **Do not exceed or fall below the permitted temperature range (5 °C to 40 °C ambient temperature) of the device.**

- Maximum relative humidity < 80 % (at ambient temperatures ≤ 31 °C)

For ambient temperatures  $U_T$  between 31 °C and 40 °C, the maximum relative humidity value  $L_F$  linearly decreases according to  $L_F = -(U_T - 55) / 0.3$ :

Ambient temperature	Max. rel. humidity
≤ 31 °C	80 %
33 °C	73.3 %
35 °C	66.7 %
37 °C	60 %
39 °C	53.3 %
40 °C	50 %

### NOTICE

N8.0015

#### Humidity

High relative humidity

- Electronic and mechanical components may be damaged.
- The performance data alter to an unknown extent.
- **The relative humidity in the vicinity of the device should be kept as low as possible.**

## 4.5 Electrical Connection

**WARNING**

W2.0015

**Danger to life through electric shock**  
 Connection to sockets without protective earth

- An electric shock can cause burns, cardiac arrhythmia, respiratory arrest, as well as cardiac arrest.
- **The device may only be operated on sockets with protective earth (PE).**

NOTICE

**Electrical connection**  
 Failure to observe the values on the type plate

- Electronic and mechanical components may be damaged.
- **Connect the device only to a mains supply matching the values on the type plate.**

N9.0022

- ⚠ WARNING** When connecting the power cable to the mains supply, use an external fuse that complies with the regulations applicable to the place of installation.
- Check the type plate for details on the necessary voltage, frequency, and maximum external current source fuse for the device.
  - The listed values must agree with the existing mains supply.
  - Only use the supplied power cable to connect the device to the mains supply.

## 4.6 Type Plate Description

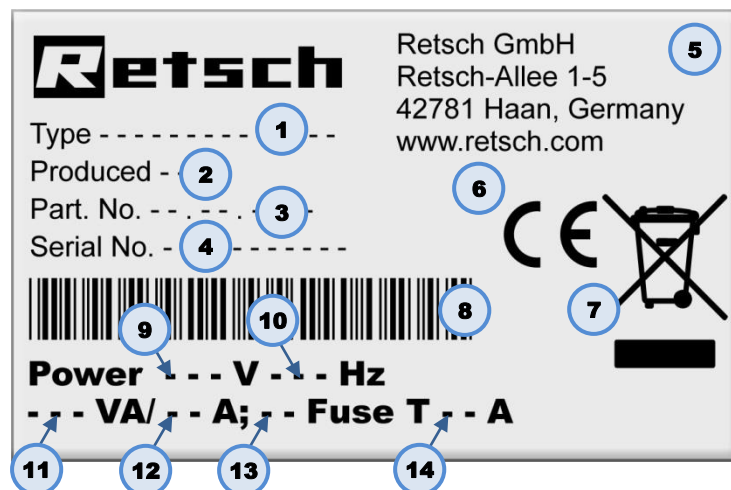

Fig. 1: Type plate

- 1 Device designation
- 2 Year of production
- 3 Part number
- 4 Serial number
- 5 Manufacturer's address
- 6 CE marking



- 7 Disposal label
- 8 Bar code
- 9 Power version
- 10 Mains frequency
- 11 Capacity
- 12 Amperage
- 13 Number of fuses
- 14 Fuse type and fuse strength

① In the case of queries please provide the device designation (1) or part number (3), as well as the serial number (4) of the device.

## 4.7 Removing the Transportation Lock

**⚠ WARNING** W3.0005

**Serious personal injury**  
Falling loads

- Due to the heavy weight of the device, serious personal injuries can be caused if it falls down.
- **Lifting above head height is not permissible!**



**NOTICE** N10.0018

**Transportation lock**  
Transport without transportation lock, or operation with transportation lock

- Mechanical components may be damaged.
- **Only transport the device with mounted transportation lock.**
- **Do not operate the device with built-in transportation lock.**

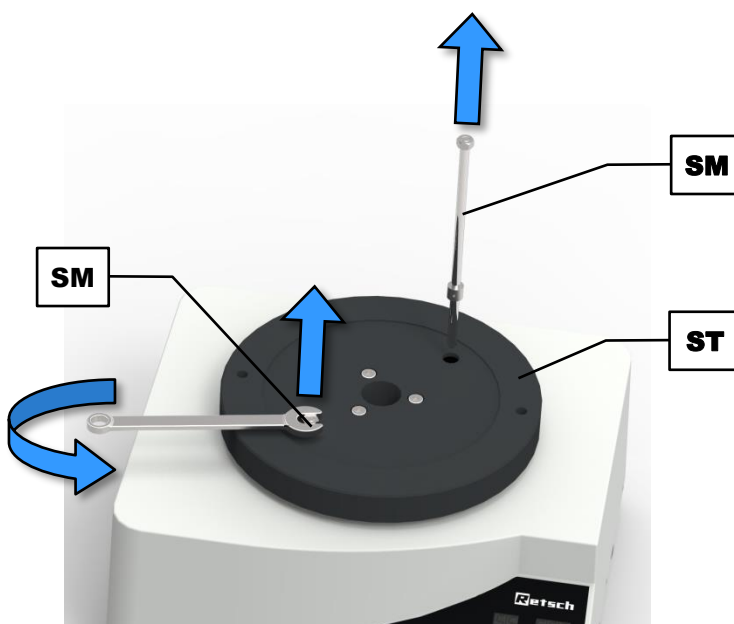
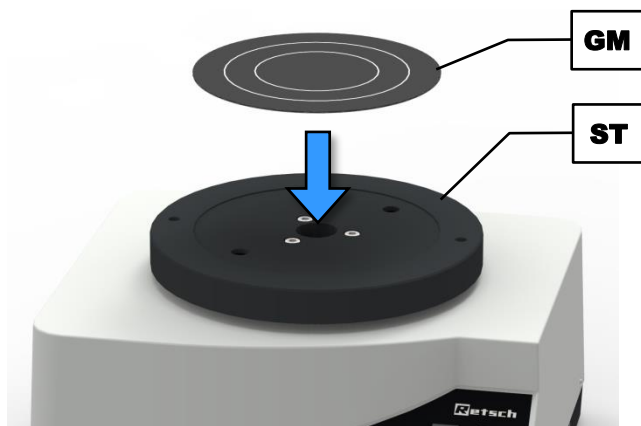

Fig. 2: Removing the transportation lock



**Fig. 3:** Mounting the rubber disc

The transportation lock consists of two long hexagonal screws (**SM**) securing the drive through the sieve plate (**ST**).

- ⇒ Loosen the hexagonal screws (**SM**) on both sides of the sieve plate (**ST**) by means of a 13 mm open-end wrench and remove them.
- ⇒ Keep the transportation lock for later transport.
- ⇒ Remove the protective foil from the adhesive tape located on the underside of the rubber disc (**GM**).
- ⇒ Position the rubber disc (**GM**) centrally on the sieve plate (**ST**) and press it down firmly.

**NOTICE** The weight without sieve stack and sieve clamping unit amounts approx. 35 kg. The device must only be lifted by two people.

## 5 First Commissioning

**WARNING**

W4.0002

**Danger to life through electric shock**  
 Damaged power cable

- An electric shock can cause burns, cardiac arrhythmia, respiratory arrest, as well as cardiac arrest.
- **Never use a damaged power cable to connect the device to the mains!**
- **Check the power cable and the plug for any damage before use.**

NOTICE

N11.0002

**Setting up the device**  
 Disconnecting the device from the mains

- A separation of the device from the mains must be possible at any time.
- **Set up the device in such a way, that the connection for the power cable is always easily accessible.**

NOTICE

N12.0004

**Setting up the device**  
 Vibrations during operation

- Depending on the operating mode of the device, slight vibrations may occur.
- **Set up the device only on a vibration-free, plane and stable surface.**

Before first commissioning the sieve clamping unit must be installed.

The AS 200 control is suitable for test sieves of 100 mm to 203 mm outer diameter. Up to 23 fractions (22 test sieves plus collecting pan with a height of 25 mm), or 11 fractions (10 test sieves plus collecting pan with a height of 50 mm) can be clamped.

**NOTICE** A high number of test sieves can significantly increase the total weight of the load (sieve stack and sample material). Make sure not to exceed the maximum payload of 9 kg.

Different sieve clamping units and lids are available for the test sieves.



**Fig. 4:** Types of the sieve clamping unit

## 5.1 Sieve Clamping Unit "economy" and "standard"

- ⇒ Screw one hexagonal nut (**G**) on the lower end of each of the threaded rods (**A**).
- ⇒ Screw both threaded rods (**A**) into the designated threaded holes (**SB**) in the sieve plate (**ST**) and lock them with the hexagonal nuts (**G**).
- ⇒ Firmly tighten the hexagonal nuts (**G**) by means of a 19 mm open-end wrench.
- ⇒ Place the desired [sieve stack](#) including the sample material centrally on the sieve plate (**ST**).
- ⇒ Lay the clamping lid "economy" (**C**) or "standard" (**D**) over the threaded rods (**A**) onto the top test sieve. The top side of the clamping lid "economy" is marked by the Retsch GmbH logo. The clamping lid "standard" is orientated so that the peripheral edge surrounds the test sieves.
- ⇒ Place the washers (**B1**) over the threaded rods (**A**) on top of the clamping lid "economy".
- ⇒ Slide the fixing nut (**B**) in an inclined position of 10° down the threaded rod (**A**) onto the clamping lid.
- ⇒ Align the fixing nuts (**B**) vertically so that the thread engages and tighten the fixing nuts hand-tight.

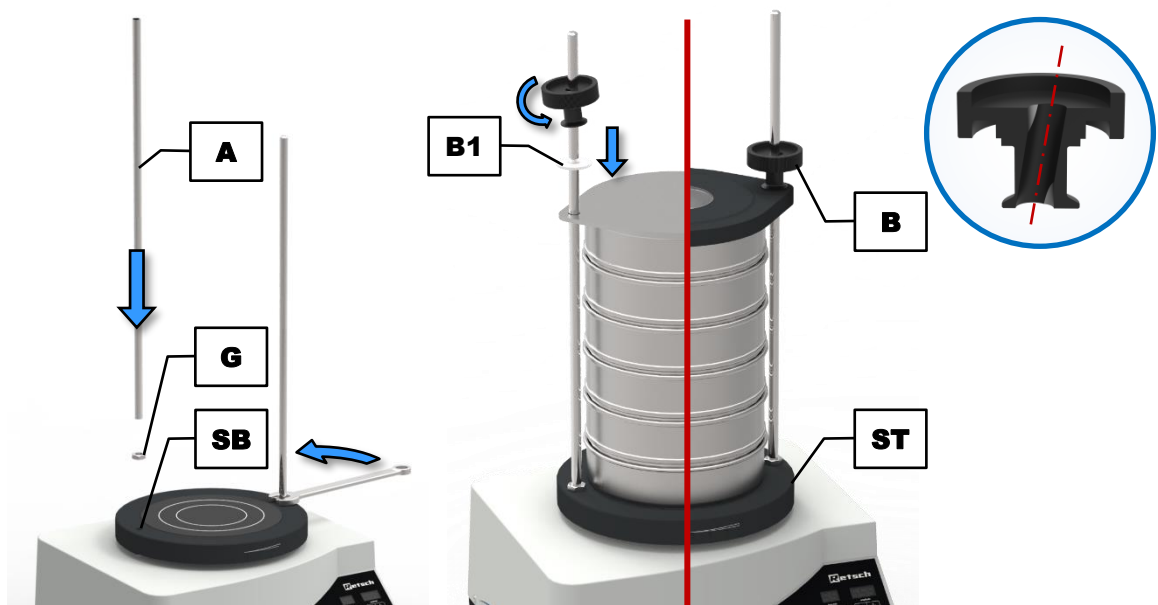

Fig. 5: Installation of the sieve clamping unit "economy" or "standard"

**NOTICE** To clamp a maximum of five test sieves and a collecting pan, shorter threaded rods are available for the sieve clamping units "economy" and "standard". For sieving processes with only one to three test sieves, the shorter threaded rods should be used. Long, projecting threaded rods disturb the spreading of the sample material due to their natural vibration behaviour.

## 5.2 Sieve Clamping Unit "comfort"

- ⇒ Put both quick clamping units (**F**) on a flat surface with the green quick clamping lever (**F1**) facing down.
- ⇒ Place the clamping lid (**D**) with the top side (plane side) face down on the quick clamping units (**F**).
- ⇒ Place the O-ring (**OR**) on the cone shaped assembly aid (**MH2**) and slide it down into the designated groove.
- ⇒ Put the assembly aid (**MH2**) in the opening of the clamping lid (**D**) in such a way that the cone shaped tip is sticking out.

- ⇒ Place the assembly aid ring (MH1) on the assembly aid (MH2) and slide it down. This presses the O-ring on the quick clamping unit and fixes the clamping lid.
- ⇒ Repeat this procedure for the other side.

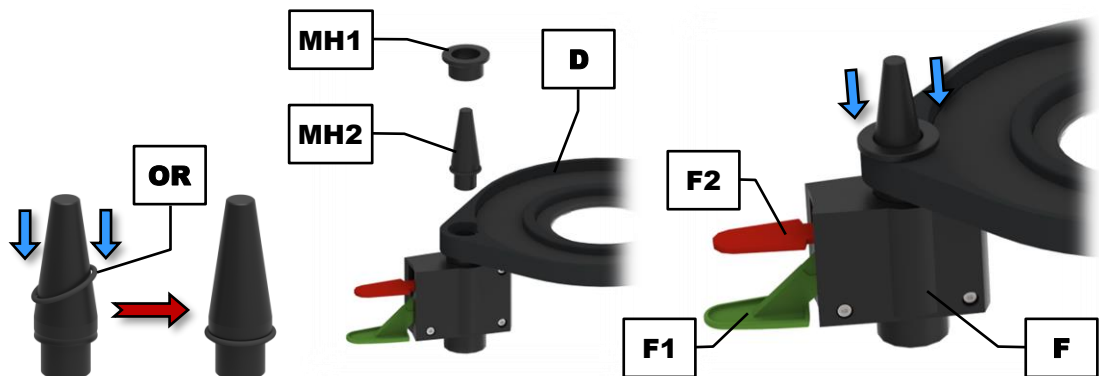

Fig. 6: Assembly of the clamping lid

- ⇒ Screw one hexagonal nut (G) on the thread of each of the support rods (E).
- ⇒ Screw both support rods (E) into the designated threaded holes (SB) in the sieve plate (ST) and lock them with the hexagonal nuts (G).
- ⇒ Firmly tighten the hexagonal nuts (G) by means of a 19 mm open-end wrench.

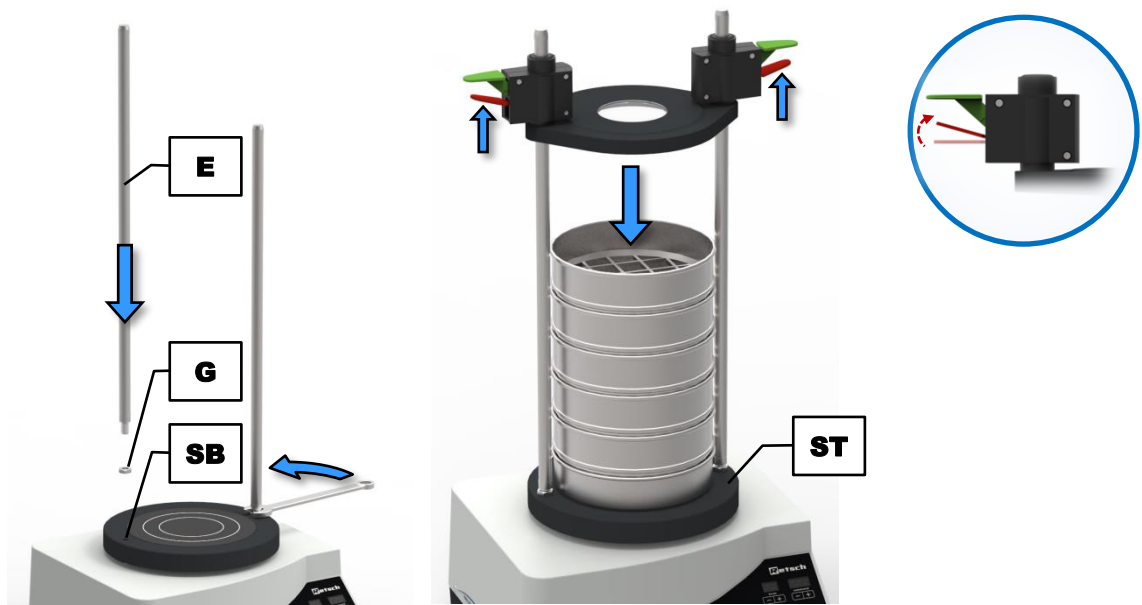

Fig. 7: Installation of the sieve clamping unit "comfort"

- ⇒ Place the desired [sieve stack](#) including the sample material centrally on the sieve plate (ST).
- ⇒ Place the assembled clamping lid on the support rods (E) with the quick clamping units facing upwards.
- ⇒ Lift the red quick clamping levers (F2) of both quick clamping units (F) for freely sliding the clamping lid up and down the support rods. Be sure not to push down the green quick clamping levers when doing so.
- ⇒ Slide the quick clamping units with the clamping lid down the support rods (E) onto the top test sieve.
- ⇒ When the clamping lid is correctly positioned on the sieve stack, press down the green quick clamping levers (F1) 1 – 2 times in order to fix the clamping lid tightly on the sieve stack.

**NOTICE** Always use both quick clamping units simultaneously! Do not activate both quick clamping levers (red and green) of one quick clamping unit at the same time.

⇒ To loosen the clamping lid after the sieving process, lift the red quick clamping levers (**F2**). Keep them lifted and slide the clamping lid upwards until the sieve stack can be removed. There is no need to take off the clamping lid completely from the support rods.

**NOTICE** If the AS 200 control is to be operated with the maximum number of test sieves, longer support rods for the sieve clamping unit "comfort" are necessary. In this case, please contact your local distributor or get in touch with Retsch GmbH directly.

 **CAUTION**

C7.0012

**Contusions and bruises**

Overturning of the sieve stack

- The sieve stack can overturn and cause personal injury.
- **Only operate the device with securely clamped sieve stack.**

## 6 Operating the Device

### 6.1 Use of the Device for the Intended Purpose

#### CAUTION

C8.0005

##### Risk of explosion or fire

Potentially explosive atmosphere

- On account of its design, the device is not suitable for use in potentially explosive atmospheres.
- **Do not operate the device in a potentially explosive atmosphere.**

#### CAUTION

C9.0006

##### Danger of personal injury

Hazardous sample material

- Depending on the dangerous nature of the sample material necessary measures must be taken to rule out any danger of personal injury.
- **Observe the material safety data sheets of the sample material.**



#### CAUTION

C10.0003

##### Risk of explosion or fire

Changing sample properties

- The properties and therefore also the hazardousness of the sample can alter during the sieving process.
- **Do not use any substances in this device which carry the risk of explosion or fire.**
- **Observe the material safety data sheets of the sample material.**



This Vibratory Sieve Shaker of the Retsch GmbH is a laboratory device. It is suitable for both, dry and wet sieving of free-flowing, disperse materials in the grain size range from 20 µm to 25 mm.

The particle size distribution of soils, building materials, chemicals, fertilizers, fillers, grains, coffee, plastics, flour, metal powders, minerals, nuts, seeds, sand, washing powder, cement clinker and many other substances can be easily and quickly analysed.

The Vibratory Sieve Shaker of the Retsch GmbH is successfully deployed in almost all areas of industry and research within the scope of quality control, especially where there are high demands regarding easy operability, speed, precision and reproducibility.

The AS 200 control is specially designed for test sieves with an outer diameter from 100 mm to 203 mm. For an optimum measurement result it is recommended to exclusively use test sieves from Retsch GmbH.

**WARNING**

W5.0010

**Handling of food, pharmaceutical and cosmetic products**

Analysed products

- Food, pharmaceutical and cosmetic products, which were analysed with the device must not be consumed, used or circulated.
- **Dispose these substances in accordance with the applicable regulations.**

**NOTICE**

N13.0007

**Range of application of the device**

Long-term operation

- This laboratory device is designed for eight-hour single-shift operation with a duty cycle of 30 %.
- **This device may not be used as a production machine nor is it intended for continuous operation.**

## 6.2 Principle of Operation

The AS 200 control performs a vibratory sieving, where the sample material is thrown upwards by the vibrations of the sieve bottom and subsequently falls back down onto the sieve mesh fabric due to gravitation forces. Thereby, the sample material is subjected to a three-dimensional movement, i.e. a horizontal circular motion superimposes the vertical throwing motion. Hence, the sample material is spread uniformly across the entire surface of the sieve bottom, whereas the particles are subjected to an acceleration in vertical direction. In this process, they perform free rotations and are compared with the mesh sizes when falling back down statistically orientated. In the Vibratory Sieve Shaker of the Retsch GmbH, an electromagnetic drive sets a spring-mass system in motion and transfers the oscillations to the sieve stack. The amplitude can be adjusted within a few millimetres.



### 6.3 Views of the Instrument

#### 6.3.1 Front



Fig. 8: Front view of the device with different sieve clamping units

Element	Description	Function
<b>A</b>	Threaded rod "economy" and "standard"	Fixes the sieve stack together with the clamping lid (C) or (D) and the fixing nut (B)
<b>B</b>	Fixing nut "economy" and "standard"	Fixes the sieve stack together with the clamping lid (C) or (D) and the threaded rod (A)
<b>C</b>	Clamping lid "economy"	Covers the top test sieve and fixes the sieve stack together with the fixing nut (B) and the threaded rod (A)
<b>D</b>	Clamping lid "standard"	Covers the top test sieve and fixes the sieve stack together with the fixing nut (B) in combination with the threaded rod (A), or the quick clamping unit (F) in combination with the support rod (E)
<b>E</b>	Support rod "comfort"	Fixes the sieve stack together with the clamping lid (D) and the quick clamping unit (F)
<b>F</b>	Quick clamping unit "comfort"	Fixes the sieve stack together with the clamping lid (D) and the support rod (E)
<b>F1</b>	Quick clamping lever green	Moves the clamping lid (D) downwards when being pressed down and thus, fixes the sieve stack
<b>F2</b>	Quick clamping lever red	Releases the clamping lid (D) when being pressed up and thus, the sieve stack
<b>G</b>	Hexagonal nut	Serves as lock nut for the screwed threaded rod (A) or support rod (E)
<b>H</b>	Operating controls	Operation of the device

6.3.2 Back



Fig. 9: Back view of the device

Element	Description	Function
<b>I</b>	Mains switch	Switches the device on and off, disconnects the device from the mains
<b>J</b>	Warning sign "Disconnect from the mains"	Warning of electric shock
<b>K</b>	Mains connection	Connection for the power cable
<b>L</b>	Fuse drawer	Contains the fuses protecting against overvoltage (fuse: 4 A delay-action at 100 – 240 V)
<b>M</b>	Type plate	Lists, among others, the voltage type, the serial number and the type of the device
<b>N</b>	Sticker "Manual"	Reminds to read the manual
<b>O</b>	USB interface	Data transfer between device and PC

## 6.4 Switching On / Off



⇒ Turn on the AS 200 control with the mains switch (**I**) on the back side of the device.

When the device is switched off, it is completely disconnected from the mains.

### Setting mode:

After switching on, the device is in the setting mode and the LED of the  button (**H1**) is lit. The displays "time" (**H5**) and "amplitude" (**H4**) show the last used values. The display "memory" (**H8**) indicates "on".

### Standby mode:

By pressing the  button (**H1**) after power on, the device can be put into standby mode. In this mode, only the LED of the  button (**H1**) is lit. All other displays are off. Except for the  button (**H2**), all buttons are inoperable.

## 6.5 Selection of the Test Sieves

The selection of the test sieves depends on the sample quantity as well as the particle size distribution. The gradation of mesh sizes and accordingly the measurement points should be selected in such a way that the complete particle size range of the sample is covered at regular intervals. The wider the particle size range, the more test sieves should be used.

## 6.6 Performing a Sieving

- ⇒ Determine the empty weights of the test sieves and the collecting pan.
- ⇒ Place the sieve stack with **increasing** mesh size on the collecting pan.

① Each test sieve is provided with an O-ring, which serves as a seal to prevent dust emission during the sieving.

- ⇒ Weigh the sample and put it on the uppermost test sieve (biggest mesh size). Make sure not to exceed the [maximum feed quantity](#).

- ⇒ Place the complete sieve stack centrally on the device and clamp the sieve stack (→ Chapter "[Sieve Clamping Unit "economy" and "standard"](#)" or "[Sieve Clamping Unit "comfort"](#)").
  - ⇒ Set the optimum amplitude value and sieving time (→ Chapter "[Controlling the Device](#)").
  - ⇒ Start the sieving process.
  - ⇒ After the end of the sieving process, weigh the individual test sieves and the collecting pan including the particle size fractions present therein.
  - ⇒ Determine the mass of the particle size fractions (weight after the sieving less the respective empty weight).
- ① The evaluation software "[EasySieve](#)<sup>®</sup>" automatically records the weights and allows for a quick and simple evaluation of the sieve analysis. When the device is controlled via EasySieve<sup>®</sup>, "ES" is indicated in the display "memory" (**H8**). A detailed description can be found in the separate manual of the software.

## 7 Controlling the Device

### 7.1 Operating Controls, Displays and Functions

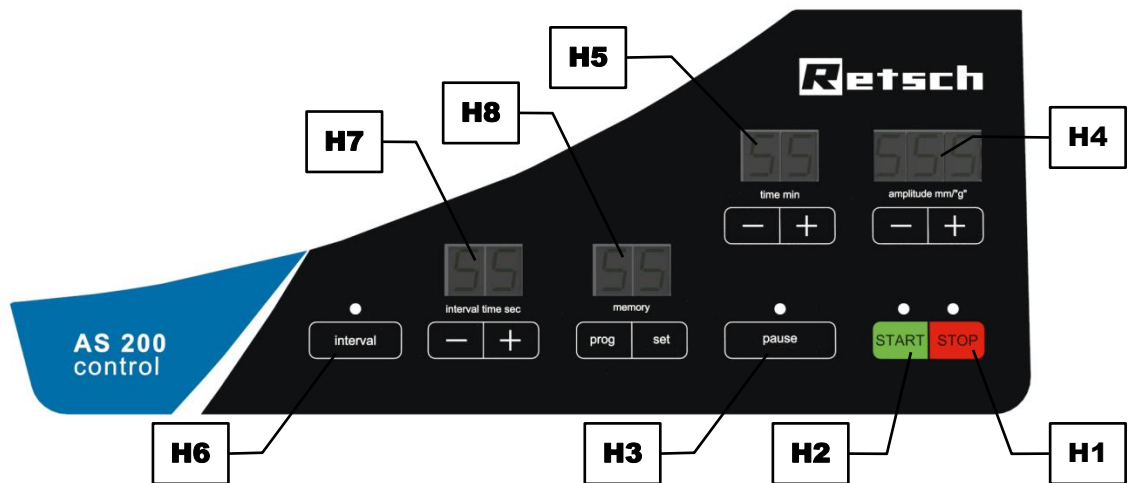





Fig. 10: Operating controls and functions

Element	Description	Function
<b>H1</b>	STOP	Stops the sieving process. In standby or setting mode, the red LED is lit
<b>H2</b>	START	Starts the sieving process. During operation, the green LED is lit
<b>H3</b>	Pause	Interrupts the sieving process. During the pause, the green LED flashes
<b>H4</b>	Amplitude setting	Decreases or increases the amplitude by pressing the "-" or "+" button, respectively in the range of 0.20 to 3.00 mm or 1 to 25.5 g
<b>H5</b>	Time setting	Reduces or extends the sieving time by pressing the "-" or "+" button, respectively in the range of 1 to 99 minutes
<b>H6</b>	Interval	Switches the device between interval and continuous operation. During the interval operation, the green LED is lit
<b>H7</b>	Interval setting	Reduces or extends the sieving time between the interval pauses by pressing the "-" or "+" button, respectively in the range of 1 to 99 seconds
<b>H8</b>	Programme setting	Allows for the saving, editing and selection of up to 99 programmes

### 7.2 Start Process



- ⇒ To start the sieving process in the [setting mode](#), press the  button (**H2**).
- ⇒ If the device is in [standby mode](#), press the  button (**H2**) **twice** to start the sieving process.

The green LED lights up and the sieving process is started. If a process time has been set beforehand, the time in the display "time" (**H5**) starts to count down on pressing the  button.

### 7.3 Stop Process

The sieving process will stop automatically after the set process time has elapsed. However, the sieving process can be stopped manually at any time.

⇒ Press the  button (**H1**) to stop the sieving process.

By pressing the  button, the sieving process stops, the red LED lights up and the green LED of the  button (**H2**) turns off.

⇒ Press the  button (**H1**) a second time to put the device into [standby mode](#).

### 7.4 Pause Process

The sieving process will stop automatically after the set process time has elapsed. However, the sieving process can be interrupted manually at any time.

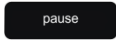
⇒ Press the  button (**H3**) to interrupt the sieving process.

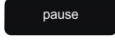
The process time is stopped and the green LED of the  button (**H3**) flashes.

#### Continue the process:

⇒ Press the  button (**H2**) to continue with the sieving process.

#### End the process:

⇒ Press the  button (**H1**) to end the sieving process.

### 7.5 Amplitude

The amplitude display (**H4**) shows the set amplitude value depending on the setting either in mm or g (acceleration of gravity). The amplitude value is adjustable between 0.20 mm (1 g) and 3.00 mm (25.5 g). When the device is switched on, the last used amplitude is preset.

⇒ Press the "+" or "-" button to set the desired amplitude.

⇒ Press and hold the "-" or "+" button to increased or decreased the amplitude in steps of 0.1 mm (1 g), respectively.

The amplitude can also be changed during operation by pressing the "+" or "-" button. An exceeding or falling below of 3.00 mm or 0.20 mm respectively is not possible.

The amplitude can either be displayed as the height of lift in mm or as a multiple of gravity g (9.81 m/s<sup>2</sup>), the so called gravitational acceleration.

⇒ Simultaneously press the "+" and "-" button to toggle the display between "mm" and "g".

During the sieving process, the amplitude is kept constant within a predetermined tolerance of 0.1 mm.

**NOTICE**

N14.0008

**Movement of the sieve stack at the beginning of the sieving process**

Insufficient clamping of the sieve stack

- During the sieving process, the sieve stack can rotate and move over the sieve plate.
- The amplitude regulation cannot find a stable oscillating system, which leads to fluctuating amplitude values.
- **Observe the sieve stack at the beginning of the sieving process.**
- **If a movement of the sieve stack can be noticed, pause the sieving process and retighten the sieve stack again.**

**7.5.1 Amplitudes in Dependence on the Load**

The AS 200 control is a resonance sieving machine whose attainable amplitude is depending on the load. In this respect, the mass (sieve stack and sieve clamping unit) fixed to the sieve plate (**ST**) plays a primary role.

Only the amplitudes specified within the following load diagram can be achieved. The diagram is to be seen as a guideline for the voltage rated on the type plate (**M**). Mains voltage fluctuations or mains voltage deviations lead to increased tolerances.

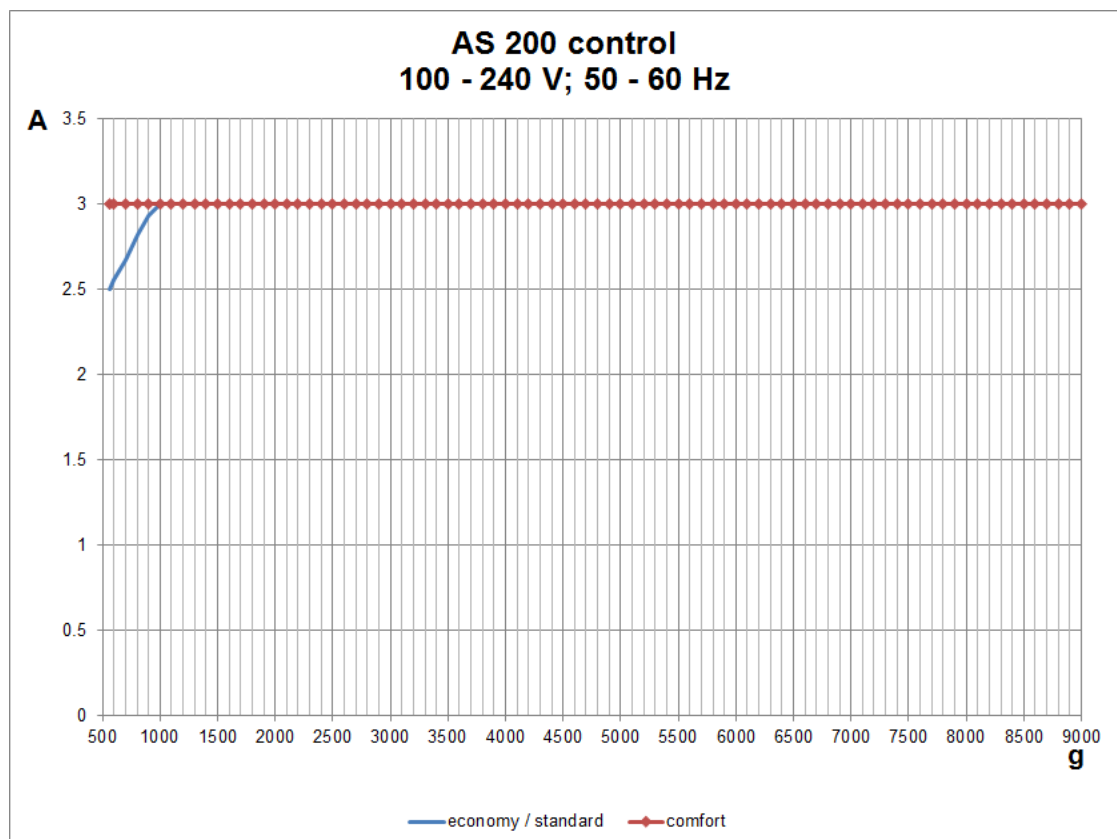

**Fig. 11:** Load diagram for the sieve clamping units "economy", "standard" and "comfort"

The diagram illustrates the amplitude "A" in millimetre in dependence of the load "g" (sieve stack mass) in gramme. The tolerance of the sieve stack mass amounts  $\pm 5\%$ . To increase the load at a too low sieve stack mass and hence to reach the maximum amplitude, an [add-on](#)

[weight](#) of 2 100 g can be additionally mounted. The best results are generally achieved with amplitudes from 1.0 to 1.5 mm.

Example 1:

Type:	230 V; 50 Hz
Sieve stack mass:	1 500 g
Sieve clamping unit:	"standard"
Add-on weight:	no

Under these conditions the maximum attainable amplitude amounts 3 mm.

Example 2:

Type:	230 V; 50 Hz
Sieve stack mass:	560 g
Sieve clamping unit:	"standard"
Add-on weight:	yes

By using the add-on mass, the maximum attainable amplitude amounts 3 mm. Without the add-on mass, the maximum attainable amplitude would only be ~ 2.5 mm.

## 7.6 Time



**Fig. 12:** Time setting for continuous operation (left) or with a process time (right)

The AS 200 control can be operated either in continuous operation or for a certain time between 1 and 99 minutes. When the device is switched on, the last used setting is displayed.

- ⇒ Press the "+" or "-" button of the time display (**H5**) to set the desired process time.
- ⇒ Press and hold the "+" or "-" button to extend or reduce the process time in steps of ten minutes, respectively.
- ⇒ To change to the continuous operation, fall below the duration of 1 min by pressing the "-" button, or exceed the duration of 99 min by pressing the "+" button. The time display (**H5**) now indicates "--".

The process time can also be changed during operation by pressing the "+" or "-" button.

## 7.7 Optimisation of Time and Amplitude

The settings of the optimum sieving time and amplitude depend on the sample material. These settings have a substantial influence on the measurement result. Generally, national and international standards, internal regulations and standards provide detailed information on product-specific sieve analyses and the associated sieving parameters. If such basic



information cannot be obtained, the sieving time and amplitude must be determined experimentally.

With the AS 200 control the amplitude is defined as the total lifting height (**SH**) of the test sieve. For example, with a set amplitude of 1.2 mm, the test sieve is displaced in the range of -0.6 mm and +0.6 mm around the zero point (= stationary sieve plate (**ST**)).

An **optimum amplitude** has been found, when a state of statistical resonance is being reached during the sieving process. Then, the particles have the biggest probability of passing, as the throw time of a particle corresponds to the oscillation period of the test sieve. In this case, the particle (**PA1**) will be moved with a different orientation to a different mesh every time the test sieve (**SH**) lifts. At too low amplitudes, the particles (**PA2**) do not lift off high enough from the sieve mesh fabric, and are therefore not able to orientate freely and move freely over the sieve mesh fabric. At too high amplitudes, the particles (**PA3**) are thrown up very high, and thus have fewer opportunities to compare themselves with the sieve meshes. The best results are generally achieved with amplitudes from 1.0 to 1.5 mm.

The **optimum sieving time** is in accordance with DIN 66165 achieved, if less than 0.1 % of the feed quantity passes the test sieve after one minute of sieving duration. In practice, the individual test sieves are weighed after the sieving process including the respective particle size fraction. Then, the sieve stack is sieved again for one minute. The weights of the individual test sieves of the second weighing must not differ substantially from those of the first weighing.

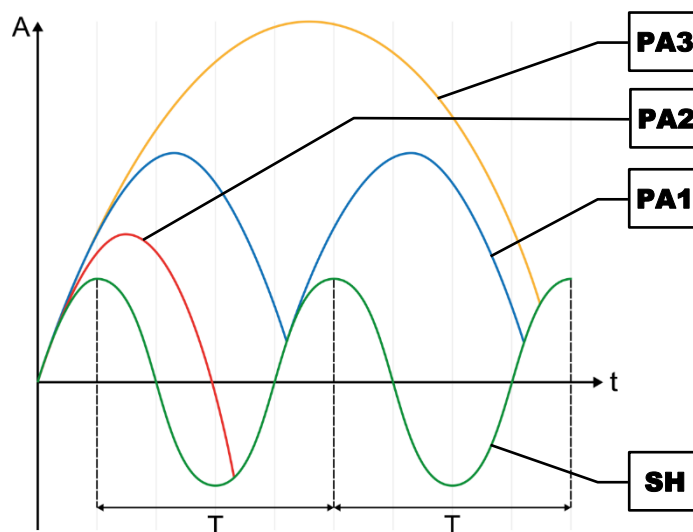



Fig. 13: Movement of the particles on the test sieve

## 7.8 Interval

- ⇒ Press the  button (**H6**) to change to the interval operation. The green LED is lit.
- ⇒ Press the  button (**H6**) again, to change back to the continuous operation. The green LED no longer lights up.

During the interval operation, the sieving process is periodically interrupted for one second. In interval operation, the interval times (pause times) are included in the displayed process time (**H5**). The interval operation can be switched on and off at any time during the sieving process.

### 7.8.1 Interval Time

With the interval time (H7) the time of the sieving process between the interval pauses can be freely selected between 1 and 99 seconds. The pause time of one second is not changeable. The display of the interval settings is only active with the interval function (H6) turned on.

- ⇒ Press the "+" or "-" button of the interval time (H7) to set the desired sieving time between the interval pauses.
- ⇒ Press and hold the "+" or "-" button to extend or reduce the interval time in steps of ten seconds, respectively.

On exceeding 99 seconds, the display changes back to 1 second. When going below 1 second, the display changes to 99 seconds. The interval time can also be changed during operation by pressing the "+" or "-" button.

### 7.9 Programme Mode

The AS 200 control allows for the saving and recalling of up to 99 parameter sets. The programme settings can only be edited in the [setting mode](#).

The currently selected programme is displayed in the display "memory" (H8). If the display indicates "on", no programme is selected and the device is in the manual mode.

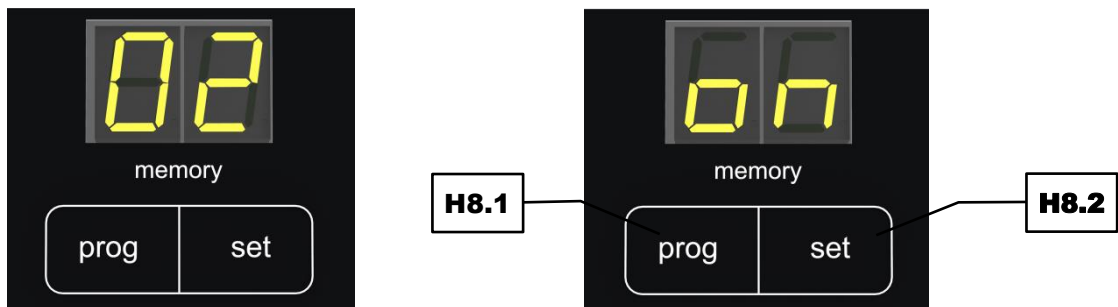

Fig. 14: Programme mode (left), manual mode (right)

#### 7.9.1 Select a Programme

- ⇒ Press the **prog** button (H8.1) to navigate through the programme memory slots in ascending order and to select the desired programme.
- ⇒ Press and hold the **prog** button to navigate through the programme memory slots in steps of 10.
- ⇒ Press the **START** button (H2) to start the sieving process in programme mode. All buttons, except for the **STOP** (H1) and the **pause** (H3) button are now locked.

Following the programme memory slot 99, "on" is again displayed in the display "memory" (H8) and the device is in manual mode. When a programme is selected, all buttons except for the **prog** (H8.1), **set** (H8.2), **START** (H2) and **STOP** (H1) button are locked.

#### 7.9.2 Edit a Programme

- ⇒ Press the **prog** button (H8.1) until the desired programme memory slot is displayed.
- ⇒ Press the **set** button (H8.2). All displays are now flashing.

- ⇒ Set the desired sieving parameters (amplitude, time, interval).





The programming can be cancelled by pressing the  button. All settings are discarded.

### 7.9.3 Save a Programme

- ⇒ Press the  button (**H8.2**) to save the set sieving parameters in the selected programme memory slot. The displays stop flashing.

### 7.10 Signal Tone

The end of the sieving process is announced with an acoustic signal.

- ⇒ Simultaneously press the  (**H6**) and  (**H1**) button to turn off the signal tone. The process is confirmed by one single signal tone.
- ⇒ Simultaneously press the  (**H6**) and  (**H2**) button to turn on the signal tone. The process is confirmed by two single signal tones.

### 7.11 Operating Hours

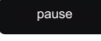
- ⇒ Simultaneously press the  button (**H3**) and the "-" button of the time display (**H5**).

The time display (**H5**) indicates "bS" (Betriebsstunden = operating hours) and the amplitude display (**H4**) displays the complete runtime (corresponds to the accumulated sieving duration) of the device in hhh format. All buttons, except for the  button (**H1**) are now locked.

- ⇒ Press the  button (**H1**) to exit the display of the operating hours.

### 7.12 Software Version

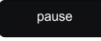

- ⇒ Simultaneously press the  button (**H3**) and the "+" button of the time display (**H5**).

The time display (**H5**) indicates "S" (software) and the amplitude display (**H4**) displays the current number of the software version. All buttons, except for the  button (**H1**) are now locked.

- ⇒ Press the  button (**H1**) to exit the display of the software version.

### 7.13 Date

By default, the reminder date for the next calibration is set to the last calibration date plus one year. However, the reminder date can be changed arbitrarily by the user.

- ⇒ Hold the  button (**H6**) for 5 seconds to display the current reminder date. The current reminder month is displayed in the time display (**H5**), whereas the current reminder year is displayed in the amplitude display (**H4**).
- ⇒ Press the "+" or "-" button of the time display (**H5**) to set the desired reminder month.
- ⇒ Press the "+" or "-" button of the amplitude display (**H6**) to set the desired reminder year.
- ⇒ Press the  button (**H1**) to save the settings and to exit the display.

Once the reminder date is reached, the information note "CAL" appears for approx. three seconds in the amplitude display (**H4**) each time the device is switched on.

A correctly set reminder date is important for the adherence of the calibration intervals. Especially, when the device is used in quality control and thus must be regularly calibrated in accordance with DIN EN ISO 9000 ff.

## 8 Wet Sieving

**⚠ WARNING** W6.0001

**Danger to life through electric shock**  
Wet sieving

- An electric shock can cause burns, cardiac arrhythmia, respiratory arrest, as well as cardiac arrest.
- **Never operate the device in a water drain basin!**
- **Do not touch the device, if water has entered the interior!**
- **Always operate the device with a mains socket protected by a residual current circuit breaker (RCCB).**



**⚠ WARNING** W7.0008

**Danger to life through electric shock**  
Ingress of water if the mains plug is not completely plugged in

- Water can enter the IEC socket and cause an electric shock if the mains plug is not completely plugged in.
- **Only operate the device with the mains plug fully plugged in.**



**NOTICE** N15.0049

**Damage to the sieve mesh fabric**  
Fluid retention during wet sieving

- Fluid retention can lead to overload and therefore to the damage or destruction of the sieve mesh fabric.
- **Observe the recommended flow rate.**
- **Always dose the quantity of liquid applied in such a way that no fluid retention can occur.**
- **Use venting rings, if necessary.**

### 8.1 Installing the Splash Protection

**⚠ CAUTION** Never carry out a wet sieving without mounted splash protection!

The splash protection (**SP**) is supplied together with the wet sieving lid.

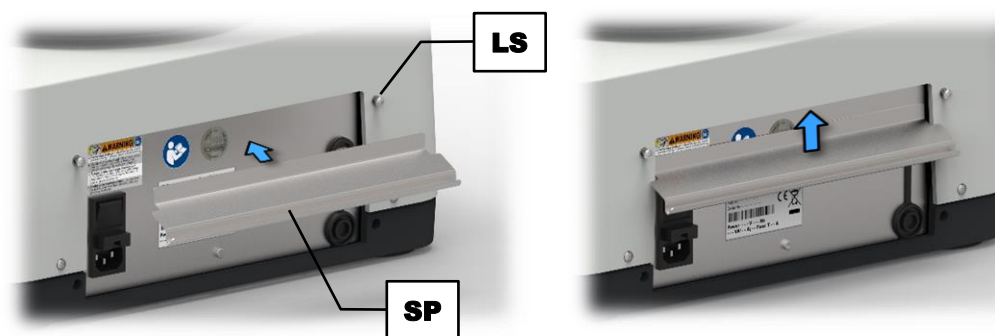

Fig. 15: Installing the splash protection

- ⇒ Loosen the two upper M4 oval-head screws (**LS**) on the backside of the AS 200 control.
- ⇒ Slide the splash protection from below up behind the top edge of the housing.
- ⇒ Retighten the two upper M4 oval-head screws (**LS**).



**Fig. 16:** AS 200 control with splash protection

## 8.2 Performing the Wet Sieving

Usually, sieving processes are carried out dry. However, when agglomerates, electrostatic charges or a high degree of fines impede the sieving process, either [sieving aids](#) can be used, or a wet sieving can be performed.

For wet sieving, a liquid, preferably water, is supplied to the sample material during the sieving process. A condition for wet sieving, however, is that the material to be sieved does not swell, dissolve or otherwise change in the liquid. Wet sieving is particularly suitable for materials which are already in suspension and may not be dried.

In addition to the test sieves, a collecting pan (**AB1**) with an outlet (**AB2**) and a wet sieving lid (**ND1**) with spray nozzle (**ND2**) are required for wet sieving. During the sieving process liquid is introduced via the spray nozzle (**ND2**) situated on top of the upper most test sieve into the sieve stack and, subsequently, leaving it again together with the last fraction via the outlet (**AB2**) of the collecting pan (**AB1**).

- ⇒ Position the device in the vicinity of the drain point (e.g. drain in the floor). The distance between the outlet (**AB2**) and the drain point should not be too large.
- ⇒ Connect the spray nozzle (**ND2**) of the wet sieving lid (**ND1**) with the liquid supply (e.g. water tap). The inner diameter of the hose must be 13 mm.
- ⇒ Connect the outlet (**AB2**) of the collecting pan (**AB1**) with the drain point or a corresponding receptacle. The inner diameter of the hose must be 20 mm. Make sure that the drain point or the receptacle are located **below** the collecting pan (**AB1**) and that the hose has a **continuous slope down**.

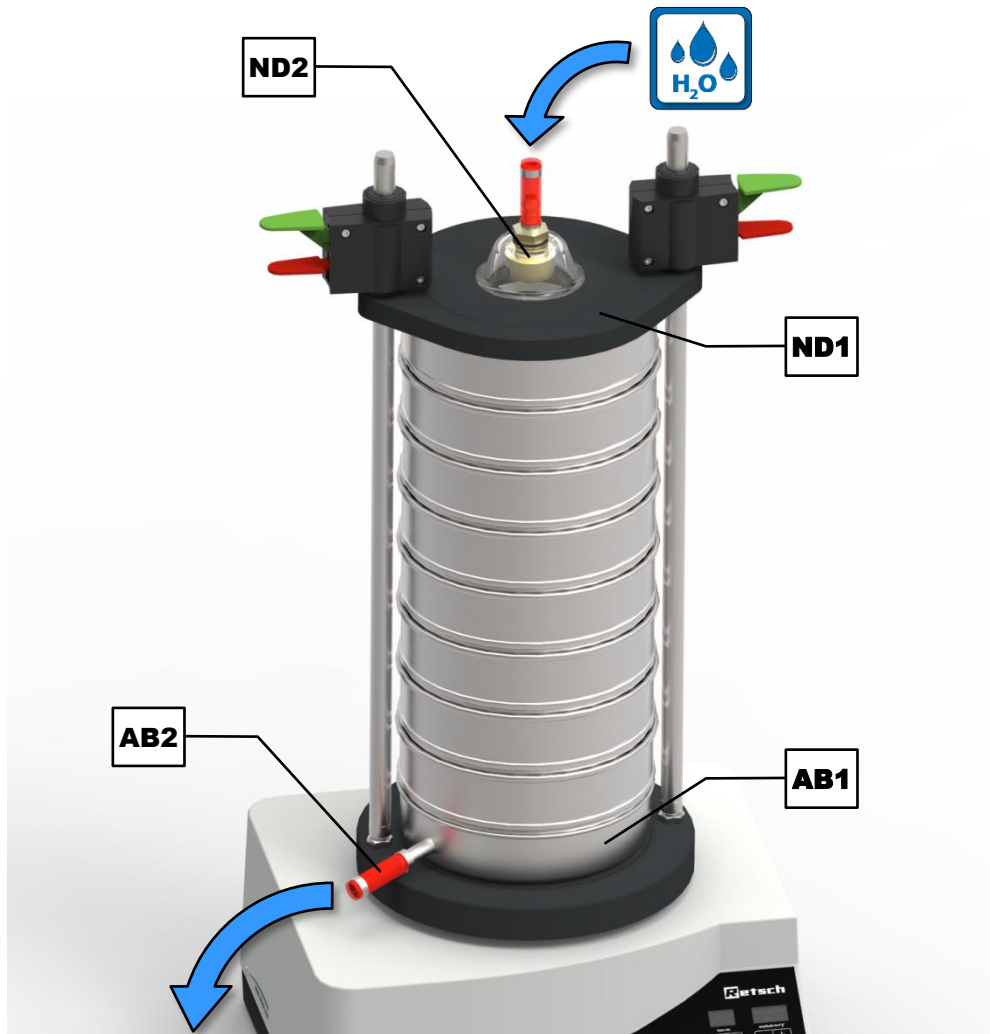

Fig. 17: Wet sieving

- ⇒ Suspend the sample material in a beaker containing the liquid intended for the wet sieving. To reduce the surface tension and to facilitate the screenings of the material later on, a few drops of surfactant may be added.
- ⇒ Moisten each test sieve with the liquid intended for wet sieving.
- ⇒ Place the sieve stack with **increasing** mesh size on the collecting pan with outlet.
- ⇒ Place venting rings (**ER**) between test sieves of mesh size < 100  $\mu\text{m}$  to avoid air cushions.
- ⇒ Place the complete sieve stack centrally on the device.
- ⇒ Enter the sample suspension on the uppermost test sieve with the clamping lid open.
- ⇒ Clamp the sieve stack (→ Chapter "[Sieve Clamping Unit "comfort"](#)").
- ⇒ Set the optimum amplitude value and sieving time (→ [recommended parameters](#)).
- ⇒ Start the sieving process.
- ⇒ Turn on the liquid supply. The quantity of liquid applied should only be of such amount that the sieve mesh area is completely sprayed. A flow rate of 200 to 300 ml per sieve surface in  $\text{dm}^2$  and minute is recommended (e.g. 0.5 to 1 litre per minute for sieve diameters of 200/203 mm).
- ⇒ The sieving process is considered as terminated when the exiting liquid shows no turbidity anymore.



**Fig. 18:** Venting ring

If the smallest fraction, that leaves the collecting pan should also be weighted, it must be appropriately collected. After the sieving process, the individual fractions are transferred on suitable tared filters (paper filter) and dried in an oven at 80 °C until the weight remains constant.

**NOTICE** Used test sieves must be cleaned immediately after the sieving process (→ Chapter "[Cleaning of Test Sieves](#)"). Depending on the sample material flash rust can form in the sieve mesh fabric.

① The [load diagrams](#) are invalid for the wet sieving. Due to the non-defined quantity of liquid in the sieve stack, binding statements are not possible for the wet sieving.

**Recommended parameters** for wet sieving:

- Amplitude: 1 mm to 1.2 mm
- Interval operation: yes
- Time: 5 min



## 9 EasySieve®

EasySieve® is a software for particle size analysis and simplifies the manual evaluation in many respects. The software is able to automatically perform the required measuring and weighing processes – from determining the weights of the test sieves to evaluating the data.

The software is structured in a self-explanatory way and follows the logical chain of events involved in a particle size analysis. Therefore, the training period will be very short. The abundance of evaluation options provides absolute flexibility in adapting to demanding, individual tasks.

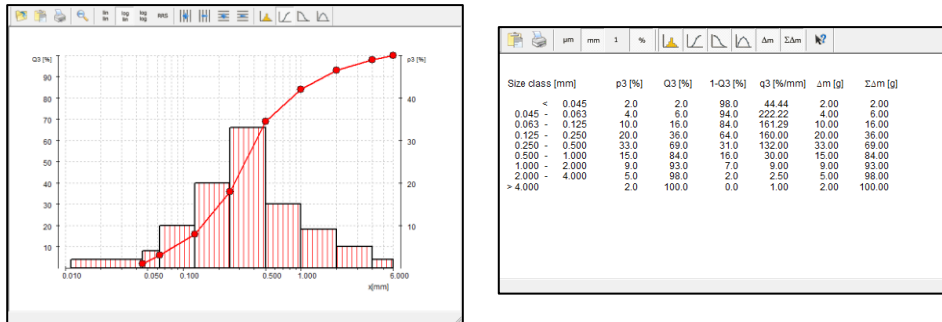

Fig. 19: Graphic and tabular presentation of the particle size analysis with EasySieve®

The software communicates with the scale and the AS 200 control and guides the user through the respective steps. Available parameters, as well as the characteristics to be calculated can be entered in various edit boxes. Routine parameters can be edited, saved and recalled at any time.

If a scale is connected, the corresponding data (empty weights of test sieves, back weights of loaded test sieves) can be transferred directly to EasySieve®. If no scale is connected, the input can also be entered manually.

The software calculates all standard particle distributions, as well as the representative characteristics of the particle size, and allows for the tabular and graphical presentation of results in a measurement report conforming to standards. Furthermore, the data can be exported to other software products (e.g. Microsoft Excel).

EasySieve® is also available as AuditTrail enabled version in compliance with 21CFR Part 11.

① A detailed description can be found in the separate manual of the software.

## 10 Error Messages and Information Notes





### 10.1 Error Messages

Error messages inform the user about detected device or programme errors. In the event of an error message, a fault has occurred, in which the operation of the device or the programme is automatically interrupted. Such faults must be resolved before next startup.

Error code	Description	Measures
<b>E10</b>	Drive overload	⇒ Switch off the main switch and wait for 30 s before switching on again. ⇒ If the error persists, contact service.
<b>E26</b>	Failure frequency converter	⇒ Switch off the main switch and wait for 30 s before switching on again. ⇒ If the error persists, contact service.
<b>E45</b>	Failure acceleration sensor	⇒ Switch off the main switch and wait for 30 s before switching on again. ⇒ If the error persists, contact service.

### 10.2 Information Notes

Notices inform the user on specific device or programme processes. The operation of the device or programme may be interrupted briefly, but there is no fault. The information notice must be acknowledged by the user to continue the process. Information notices provide additional information for the user as an aid, but do not represent any device or programme errors.

Notice code	Description	Measures
<b>bS</b>	Display of the complete runtime in hhh	⇒ Press the  button to exit the display.
<b>CAL</b>	Calibration required	⇒ Press the  button to exit the display. ⇒ Contact the service to arrange an appointment for the calibration.
<b>dA</b>	Current date required	The device was not connected to the mains or off for more than 30 days, whereby the battery is discharged and the current date has been deleted. ⇒ Press the  button. The time display shows the month "01". The amplitude display shows the year "-00". ⇒ Use the respective "+" and "-" buttons to set the current month (e.g. "04" for April) and the current year (e.g. "-16" for 2016). ⇒ Press the  button to save the current date and to exit the display. ⇒ Leave the device connected to the mains and powered on for at least two hours, in order to fully charge the battery.

<b>ES</b>	External control by EasySieve®	The device is controlled by the EasySieve® software installed on a PC. ⇒ Close the software to restore the manual control.
<b>S</b>	Display of the software version	⇒ Press the  button to exit the display.

## 11 Return for Service and Maintenance



**Fig. 20:** Return form

The acceptance of devices and accessories of the Retsch GmbH for repair, maintenance or calibration can only be effected, if the return form including the decontamination declaration service has been correctly and fully completed.

- ⇒ Download the return form located in the download section "Miscellaneous" on the Retsch GmbH homepage (<http://www.retsch.com/downloads/miscellaneous/>).
- ⇒ When returning a device, attach the return form to the outside of the packaging.

In order to eliminate any health risk to the service technicians, Retsch GmbH reserves the right to refuse the acceptance and to return the respective delivery at the expense of the sender.

## 12 Cleaning, Wear and Maintenance

### 12.1 Cleaning





**WARNING**

W6.0003

**Danger to life through electric shock**  
Cleaning with water

- An electric shock can cause burns, cardiac arrhythmia, respiratory arrest, as well as cardiac arrest.
- **The power cable must be unplugged before cleaning the device.**
- **Use a cloth dampened with water for cleaning.**
- **Do not clean the device under running water!**

**NOTICE**

N16.0009

**Damage to the housing and device**  
Use of organic solvents

- Organic solvents may damage plastic parts and the coating.
- **The use of organic solvents is not permitted.**

⇒ Clean the housing of the device with a damp cloth and if necessary, with a household cleaning agent. Pay attention that no water or cleaning agent enters the interior of the device.

#### 12.1.1 Cleaning of Test Sieves

Test sieves are measuring instruments and should be treated with due care before, during and after the sieving process. It is recommended to clean new test sieves before the first use from possible preservative residues with ethanol or isopropanol and to store them in a dry, dust-free place when unused.

Before cleaning or drying the test sieves, the O-rings have to be removed. Before using and after the cleaning the test sieves should be visibly inspected for possible damages and impurities.

Near-mesh or clumped particles can be often removed dry after the sieving process by slightly tapping the test sieve upside down with the sieve frame on a table. For test sieves with mesh sizes > 500 µm a fine hair brush can be used to sweep over the outer side of the mesh fabric.

##### 12.1.1.1 Cleaning of Test Sieves with Mesh Sizes > 500 µm

Coarse mesh fabrics with mesh sizes > 500 µm can be cleaned dry or wet easily and effectively with a hand brush with plastic bristles (at not too high applied pressure).

##### 12.1.1.2 Cleaning of Test Sieves with Mesh Sizes < 500 µm

Test sieves with mesh sizes < 500 µm should generally only be cleaned in an ultrasonic cleaning-bath. As cleaning agent, water together with a standard surfactant is recommended. The cleaning in the ultrasonic bath usually takes two to three minutes. After that the test sieves

are thoroughly rinsed with water and dried. The cleaning with strong bases or acids is generally not recommended.

### 12.1.1.3 Drying of Test Sieves

Drying ovens of various sizes can be used for drying test sieves (drying temperature < 80 °C).

Additional information concerning ultrasonic cleaning-baths and drying ovens can be found on the Retsch GmbH homepage (<http://www.retsch.com>). Also ask for the free expert guide *Sieve Analysis – Taking a close look at quality*.

#### NOTICE

N17.0028

##### Damage of the sieve mesh fabric

Drying temperature > 80 °C

- At higher temperatures, especially fine metal wire meshes can become warped, leading to a reduced tension of the mesh fabric inside the sieve frame and hence, makes the test sieve less efficient during the sieving process.
- **The drying temperature for test sieves must not exceed 80 °C!**

## 12.2 Wear

Even with the proper handling of the test sieves, a wearing of the sieve mesh fabric depending on the frequency of the sieving operation and on the sample material is unavoidable. The test sieves should be regularly checked for wear and damage and be replaced if necessary.

Likewise, all existing sealing gaskets should be checked for wear on a regular basis and replaced if necessary.

#### ⚠ CAUTION

C11.0013

##### Personal injury

Improper repairs

- This manual does not contain any repair instructions.
- **For safety reasons, repairs may only be carried out by Retsch GmbH or an authorised representative or by qualified service technicians.**

## 12.3 Maintenance

The AS 200 control is largely maintenance-free.

When using the sieve clamping unit "comfort" it is recommended to clean the support rods from time to time. Furthermore, after a certain time the sieve clamping unit "comfort" produces unavoidable, function-related clamping grooves on the support rods, which may impede secure clamping. Therefore, it is necessary to examine the support rods in regularly intervals for clamping grooves in the clamping area and, if required, to turn them by 90°.

- ⇒ Loosen the hexagonal nut (**G**) by means of a 19 mm open-end wrench.
- ⇒ Turn the support rod by 90°.
- ⇒ Then, tighten the hexagonal nut again.

If the rotation of the support rods does not expose a clamping groove free area, the support rods should be replaced.

If wet sieving is executed, a quarterly examination for tightness of the fluid hoses should be performed.

If the AS 200 control is used in quality control, it should be regularly calibrated in accordance with DIN EN ISO 9000 ff. For this purpose please contact your local distributor or get in touch with Retsch GmbH directly.

### 12.3.1 Replacing the Fuses

**WARNING**

W9.0014

**Danger to life through electric shock**  
Exposed power contacts

- When replacing the fuses, contact to live contacts on the fuse or the fuse receptacle can lead to an electric shock.
- An electric shock can cause burns, cardiac arrhythmia, respiratory arrest, as well as cardiac arrest.

- **The power cable must be unplugged before exchanging the fuses.**

Voltage	Fuse
100 – 240 V	4 A delay-action

Two fuses are located in the fuse drawer (L) on the backside of the device. Fuses can be replaced by trained qualified personnel.

- ⇒ Remove the fuse drawer by pressing the latch on the bottom side of the fuse drawer.
- ⇒ Replace the defective fuse in the fuse drawer.
- ⇒ Slide the fuse drawer back in again, until it audibly locks in place.

## 13 Accessories

Information on available accessories as well as the respective manuals are accessible directly on the Retsch GmbH homepage (<http://www.retsch.com>) under the heading "Downloads" of the device.

Information on wear parts and small accessories can be found in the Retsch GmbH general catalogue also available on the homepage.

In case of any questions concerning spare parts please contact the Retsch GmbH representative in your country, or Retsch GmbH directly.

### 13.1 Test Sieves

Decisive for the accuracy and reliability of the measurement result is, in addition to the reproducible operating Vibratory Sieve Shaker the quality of the test sieve. Test sieves of Retsch GmbH are high quality measuring instruments for which only mesh fabrics and perforated sheets of the corresponding standards are used. Each test sieve is tested five times and is given a serial number, as well as a quality certificate after the final check.

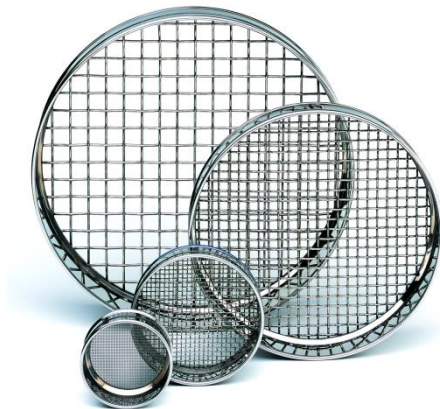

**Fig. 21:** Test sieves

The different versions of the test sieves of Retsch GmbH are supplied in accordance with all current national and international standards:

- available standards: DIN, ISO, ASTM, BS, NF, CGSB
- available diameters: 100 mm / 150 mm / 200 mm / 203 mm (8") / 305 mm (12") / 400 mm / 450 mm (18")
- available sieve surfaces: sieve mesh fabric (20 µm to 125 mm) and perforated screens (round, elongated or square holes) of stainless steel
- on request with an individual test certificate for the inspection of measuring and testing equipment monitoring according to ISO 9000 ff.

Among the various test sieves matching collecting pans, collecting pans with outlet, intermediate pans, intermediate rings, venting rings and sieve lids are available.

#### 13.1.1 Certificate

Before delivery, each test sieve is optically surveyed according to the standards DIN ISO 3310-1 and ASTM E 11, and provided a certificate of compliance with the order.



On request, an additional acceptance test certificate with a calibration protocol can be provided, documenting the measurement results in tabular and graphical form, hence representing a calibration certificate with more detailed statistics.

### 13.1.2 Calibration Service

As a special service Retsch GmbH offers the calibration of the test sieves. All relevant information are recorded during the standard measuring process of the test sieve and confirmed in the required certificate.

## 13.2 Sieving Aids

### NOTICE

N18.0027

#### Damage of the sieve mesh fabric

Use of mechanical sieving aids

- When using mechanical sieving aids, there is a danger that fine sieve mesh fabrics might be damaged.
- **Ensure that no overstretching of the sieve mesh fabric occurs due to overloading with sieving aids.**
- **If in doubt, please contact your local distributor or Retsch GmbH directly.**

By electrostatic and Van-der-Waals forces, as well as by fluid bridges, single particles can combine to form agglomerates. Since in this case not the individual primary particles, but particle collectives are measured, there is a distortion of the particle size distribution (a higher coarse fraction results). In order to prevent the formation of agglomerates or dissolve them, sieving aids can be used.

#### Mechanical sieving aids:

Mechanical sieving aids cause a destruction of agglomerates and dislodge wedged particles from the sieve meshes. Depending on the mesh size of the test sieve and the preselected amplitude, balls of agate, rubber, steatite or cubes of polyester urethane rubber, and nylon brushes or stainless steel chain rings can be used for this purpose.

**NOTICE** For very soft sample material, an undesired crushing of primary particles might occur.

#### Solid additives:

Solid additives, such as talcum or Aerosil® can be admixed to fatty, moist, sticky or oily sample materials. They attach themselves to the particle surface and counteract the formation of agglomerates. Their particle size is so small that they have no sustainable influence to the actual particle size analysis of the sample material. However, the measurement results will be distorted depending on the added amount of additive.

#### Liquid sieving aids:

Antistatic spray, benzene, alcohol and surfactants can be used as liquid sieving aids, though benzene and alcohol are only to be used during sample preparation. They reduce the electrostatic charges, wash out fatty or oily components of the sample material, or diminish the surface tension in the wet sieving.

### 13.3 Add-on Weight

If the mass of the sieve stack is too low, the necessary amplitude required for the sieve analysis cannot always be reached. To compensate for this, an additional mass of 2 100 g for test sieves with a diameter  $\leq 203$  mm can be placed underneath the sieve stack on the sieve plate and be clamped together with the sieve stack.

## 14 Disposal

In the case of a disposal, the respective statutory requirements must be observed. In the following, information on the disposal of electrical and electronic devices in the European Community are given.

Within the European Community the disposal of electrically operated devices is regulated by national provisions that are based on the EU Directive 2012/19/EU on Waste Electrical and Electronic Equipment (WEEE).

Accordingly, all devices supplied after August 13<sup>th</sup> 2005 in the business-to-business area, to which this product is classified, may no longer be disposed of with municipal or household waste. To document this, the devices are provided with the disposal label.

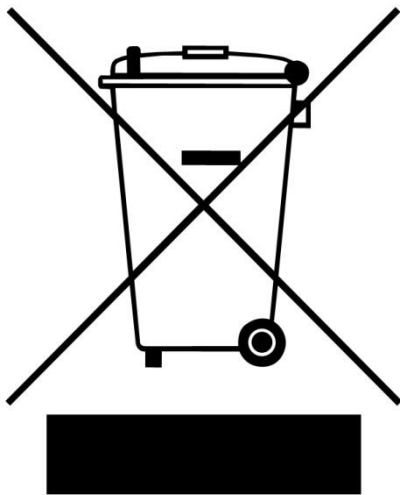

**Fig. 22:** Disposal label

Since the disposal regulations worldwide and also within the EU may differ from country to country, the supplier of the device should be consulted directly in case of need.

This labelling obligation is applied in Germany since March 23<sup>rd</sup> 2006. From this date on, the manufacturer must provide an adequate possibility of returning all devices delivered since August 13<sup>th</sup> 2005. For all devices delivered before August 13<sup>th</sup> 2005 the end user is responsible for the proper disposal.

## 15 Index

### A

Accessories .....	48
Action instructions .....	7
Add-on weight .....	32, 50
Ambient temperature .....	15
Amperage .....	17
Amplitude .....	30
definition .....	33
dependence on the load .....	31
optimisation .....	32
optimum .....	33
setting .....	29
Application-technical information .....	6

### B

Back .....	26
Back view .....	26
Bar code .....	17

### C

CAL .....	35
Calibration .....	35, 44
Calibration service .....	49
Capacity .....	17
CE marking .....	16
Certificate .....	48
Clamping lid	
assembly .....	21
economy .....	26
standard .....	26
Cleaning .....	45
Collecting pan with outlet .....	38
Complaints .....	14
Condensation .....	14
Confirmation form for the managing operator .....	10
Continuous operation .....	32
Controlling the device .....	29
Copyright .....	6

### D

Date .....	35
Degree of protection .....	11
Depth .....	12
base .....	12
Device designation .....	16
Dimensions .....	12
Disclaimer .....	6
Disconnection from the mains .....	19
Displays .....	29
Disposal .....	51
label .....	17, 51
regulations .....	51

### E

EasySieve® .....	28, 41
Electrical connection .....	16
Electromagnetic compatibility .....	12

EMC .....	12
Emissions .....	11
Equivalent continuous sound level .....	11
Error	
E10 .....	42
E26 .....	42
E45 .....	42
Error messages .....	42
Evaluation .....	41
Explanations of the safety instructions .....	7
External fuse .....	16

### F

Feed grain size .....	13
Feed quantity .....	12
First commissioning .....	19
Fixing nut .....	26
Frequency .....	16
Front .....	25
Front view .....	25
Functions .....	29
Fuse strength .....	17
Fuse type .....	17
Fuses .....	27
replacing .....	47

### G

General catalogue .....	48
General safety instructions .....	8
Grain size	
range .....	23
Gravitational acceleration .....	30

### H

Hearing damage .....	11
Height .....	12
Height of lift .....	30
Hexagonal nut .....	26
Humidity .....	15

### I

Information note	
bS .....	42
CAL .....	42
dA .....	42
ES .....	43
S .....	43
Information notes .....	42
Installation .....	14
Installation height .....	15
Installation site	
conditions .....	15
Interval .....	29, 33
setting .....	29
Interval time .....	34

<b>L</b>		
L <sub>eq</sub> .....	11	
Lifting the device .....	18	
Load diagram .....	31, 40	
Location requirements .....	12	
Long-term operation .....	24	
<b>M</b>		
Mains connection .....	27	
Mains frequency .....	17	
Mains supply .....	16	
Mains switch .....	27	
Maintenance .....	10, 44, 45, 46	
Manual .....	6, 8, 10	
Manual mode .....	34	
Manufacturer's address .....	16	
Materials .....	23	
Measurement range .....	13	
Measurement report .....	41	
<b>N</b>		
Notes on the manual .....	6	
Number of fractions		
maximum .....	13	
Number of fuses .....	17	
<b>O</b>		
Operating controls .....	26, 29	
Operating hours .....	35	
Operating instructions .....	10	
Operating the device .....	23	
Operation .....	17	
<b>P</b>		
Packaging .....	14	
Part number .....	16	
Particle distribution .....	41	
Particle size analysis .....	41	
Particle size characteristics .....	41	
Particle size distribution .....	23	
Particle size range .....	13	
Pause .....	29	
Payload .....	13	
Performing a sieving .....	27	
Power version .....	17	
Principle of operation .....	24	
Process		
continue .....	30	
end .....	30	
pause .....	30	
start .....	29	
stop .....	30	
Programme		
editing .....	34	
saving .....	35	
selecting .....	34	
setting .....	29	
Programme mode .....	34	
<b>Q</b>		
Quick clamping lever		
		green .....
		red .....
		Quick clamping unit .....
		<b>R</b>
		Range of application of the device .....
		Rated power .....
		Receptacle volume .....
		Relative humidity
		maximum .....
		Reminder date .....
		Repair .....
		Repair instructions .....
		Required floor space .....
		Return .....
		for service and maintenance .....
		Return device .....
		Return form .....
		Revision status .....
		Rubber disc
		mounting .....
		<b>S</b>
		Safety instruction .....
		caution .....
		danger .....
		notice .....
		warning .....
		Safety manager .....
		Sample quantity
		maximum .....
		Scale .....
		Serial number .....
		Service address .....
		Setting mode .....
		Sieve clamping unit
		comfort .....
		economy .....
		installation comfort .....
		installation economy and standard .....
		standard .....
		types .....
		Sieve diameter .....
		Sieve stack
		height .....
		maximum height .....
		maximum weight .....
		Sieving aids .....
		Sieving noises .....
		Sieving time
		optimum .....
		Signal tone .....
		Signs .....
		Slash protection
		installation .....
		Small accessories .....
		Software .....
		version .....

Sound level .....	11	removing .....	17
Sound parameters .....	11	Type plate .....	16, 27
Spare parts .....	48	description .....	16
Spray nozzle .....	38	<b>U</b>	
Standby mode .....	27	USB interface .....	27
START .....	29	Use of the device for the intended purpose .....	23
STOP .....	29	<b>V</b>	
Support rod .....	26	Venting ring .....	40
long .....	22	Vibrations .....	19
Switching on / off .....	27	Vibratory sieving .....	24
Symbols .....	7	Views of the instrument .....	25
<b>T</b>		Voltage .....	16
Target group .....	8	<b>W</b>	
Technical data .....	11	Warranty claims .....	9, 14
Temperature fluctuations .....	14	Wear .....	45, 46
Temperature range .....	15	Wear parts .....	48
Temporary storage .....	14	Weight .....	12, 18
Test sieve .....	23, 48	Wet sieving .....	13, 37
cleaning .....	45	liquid .....	38
diameter .....	19	perform .....	38
drying .....	46	recommended parameters .....	40
maximum drying temperature .....	46	Wet sieving lid .....	37, 38
selection .....	27	Width .....	12
Threaded rod .....	26	base .....	12
Time .....	32	Working space .....	12
optimisation .....	32	Workplace related emission level .....	11
setting .....	29	<b>Y</b>	
Transport .....	14, 17	Year of production .....	16
Transport damage .....	14		
Transportation lock .....	17, 18		







## VIBRATORY SIEVE SHAKER

AS 200 control | 30.032.xxxx

### EU DECLARATION OF CONFORMITY

Herewith we declare, represented by the signatory, that the above mentioned device complies with the following directives and harmonized standards:

#### Machinery Directive 2006/42/EC

Applied standards, in particular:

DIN EN ISO 12100 Safety of machinery

#### EMC Directive 2014/30/EU

Applied standards, in particular:

DIN EN 55011 Industrial, scientific and medical equipment - Radio-frequency disturbance characteristics - Limits and methods of measurement

DIN EN 61000-3-2 Electromagnetic compatibility (EMC)

DIN EN 61000-3-3 Electromagnetic compatibility (EMC)

DIN EN 61326-1 Electrical equipment for measurement, control and laboratory use - EMC requirements

#### Low Voltage Directive 2014/35/EU

Applied standards, in particular:

DIN EN 61010-1 Safety requirements for electrical equipment for measurement, control and laboratory use

#### Authorized person for the compilation of technical documents:

Dr. Loredana Di Labio (technical documentation)

Furthermore, we declare that the relevant technical documentation for the above mentioned device has been compiled according to Annex VII Part A of the Machinery Directive, and we undertake to submit this documentation on request to the market surveillance authorities.

**In case of a modification of the device not previously agreed with Retsch GmbH, as well as the use of unauthorised spare parts or accessories, this declaration will lose its validity.**

Retsch GmbH



Dr. Ing. Frank Janetta, Team Leader R&D Department

Haan, 08/2017









**Retsch**<sup>®</sup>

**Copyright**

© Copyright by  
Retsch GmbH  
Retsch-Allee 1-5  
42781 Haan  
Germany