

Smooth, Live Image Display Ideal For Conferences

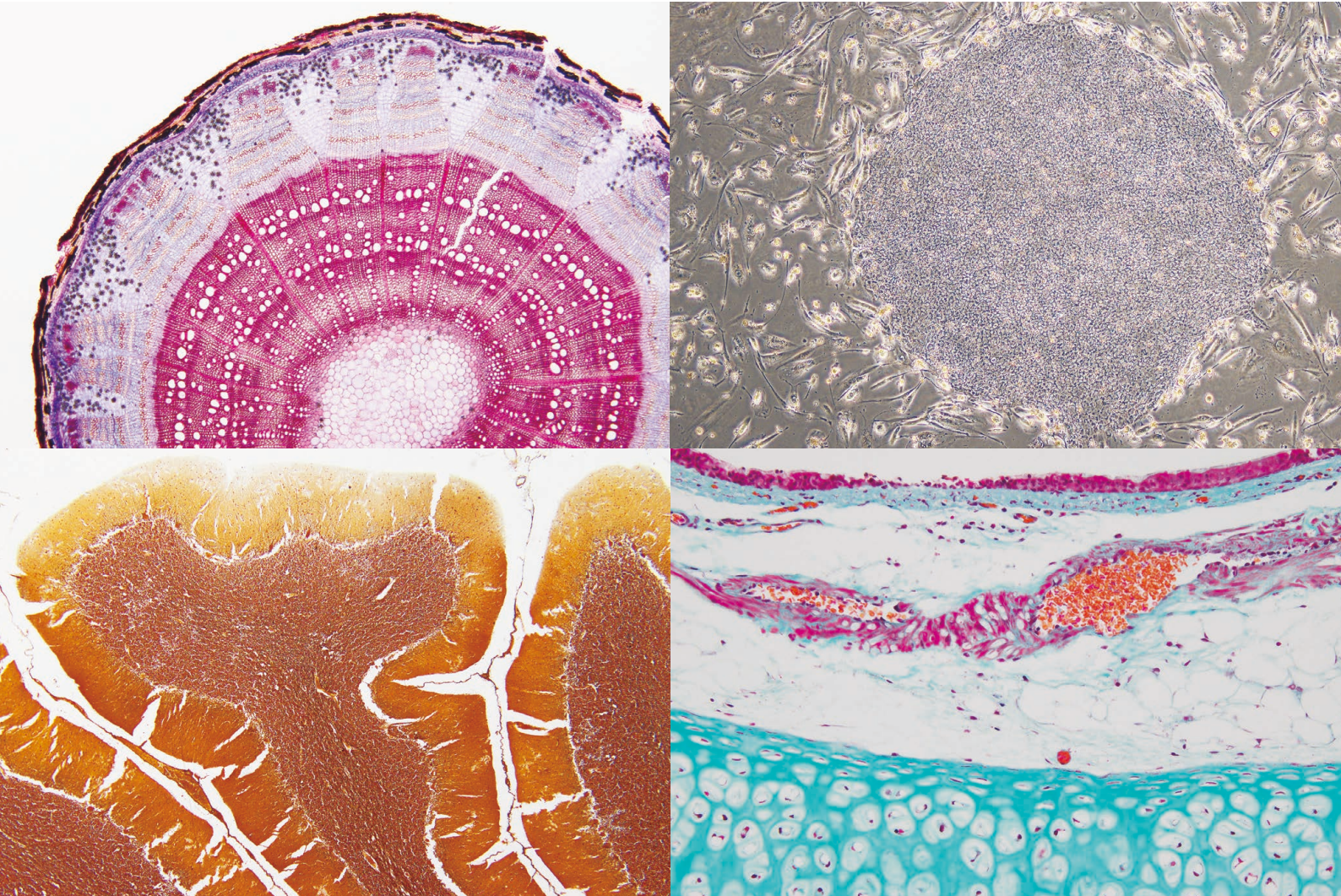

Stand-Alone Camera Featuring Smooth, Extremely Stable Live Image Display And Easy Operation

The DP22 stand-alone digital camera for microscopes allows easy observation, focusing, framing and saving while enabling smooth, live image display of high-definition images for conferences, teaching and more.



Optimized For Conferences And Lectures

◎ Excellent Color Reproduction

The DP22 captures and displays images in ultra-high resolution of 1920 x 1440 pixels, using a powerful 2.8-megapixel CCD capable of reproducing 16.7 million colors. Precise reproduction of fine structures and subtle color differences allows targets on the monitor to be identified with an accuracy equivalent to observation through microscope, assuring highly professional presentations.

◎ Live Display At 25 Frames Per Second

The DP22 displays images with resolution of 1920 x 1440 pixels — surpassing standard Full HD resolution — at a rate of 25 frames per second, commonly used for full-motion video. Images are not compressed for display so there is absolutely no degradation in quality, enabling operators to make precise focusing and framing.



Optimized for teaching

◎ Extended Movie Recording With Audio

The DP22 can record movies up to 30 minutes in length with audio. This is ideal for preparing teaching or presentation materials as it allows you to record a movie with audio while moving specimen.



Comfortable Operation Functions Of The DP22.

◎ Three Color Modes

Three color modes are provided, enabling the operator to tailor the image to suit the requirements of different applications. By selecting one of the three preset modes, optimum images can be acquired for various sample types and observations without having to change all the settings each time.

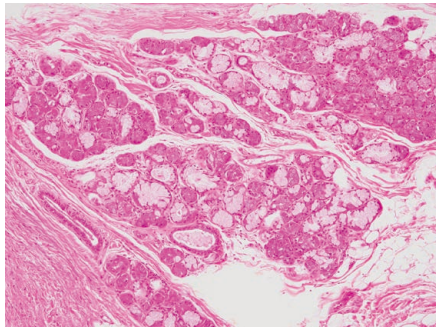

High fidelity mode

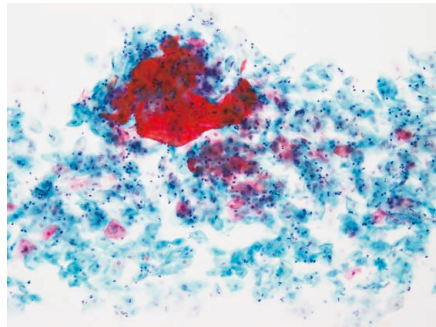

Normal mode

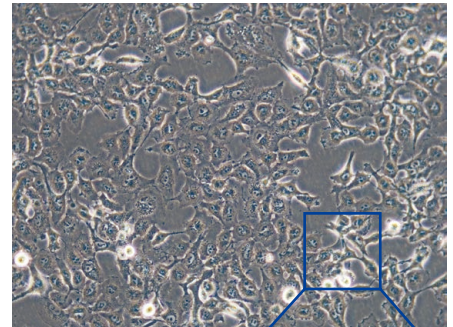

Cell culture mode

- **High fidelity mode** : Reliable color reproduction equivalent to microscope observation.
- **Normal mode** : Enhanced color facilitates acquisition of even pale stained specimens.
- **Cell culture mode** : Dedicated to phase contrast and DIC observations.

◎ Sequential Shooting And Movie Frame Clipping

DP22 high frame rate allows capturing of sharp, clear movies even when shooting fast-moving subjects. If needed the frame clipping function allows the extraction of single frames from the acquired movie.

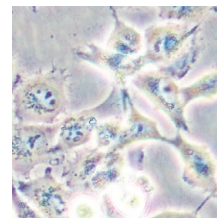

Conventional mode

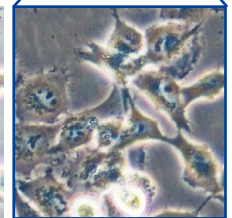

Cell culture mode:
Halation is reduced to allow clear observation of cell shapes.

Easy Operations For Capturing

◎ Simple Control Panel

Frequently used buttons are conveniently placed in the most intuitive and accessible positions. Easy-to-understand layout makes it easy even for first-time users correctly operate the camera. In addition, unnecessary buttons can be hidden on the display.

◎ Touchscreen Monitor For Intuitive Operation

When a touchscreen panel is used, the work efficiency is dramatically improved as there is no need to use the mouse or the keyboard to operate the camera.

◎ Compatibility With A Wide Range Of External Devices

An SD card, external hard drive, foot switch and/or keyboard can be connected to the control unit through the USB interface.

* Please contact your Olympus local representative for the usable USB devices.

◎ Easy Image Capturing Using A Mouse

Images can be captured as required simply by double-clicking the mouse in the live image.

◎ Easy USB 3.0 Connection

The DP22 is compliant with the USB 3.0 standard for quick connection to compatible computers and fast transfer of image data.

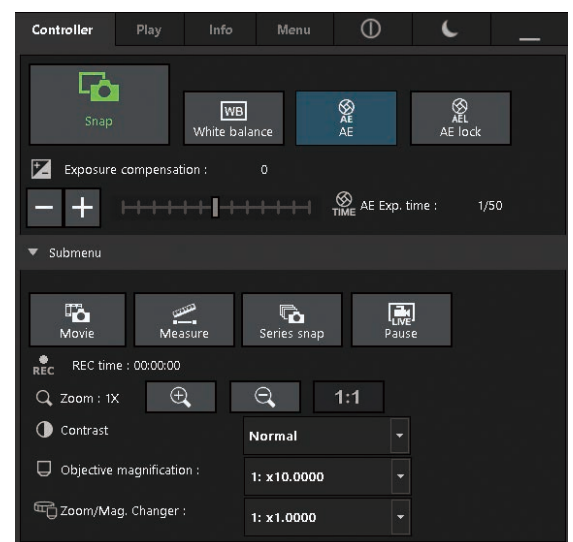

Control screen

DP22 stand-alone configuration system diagram

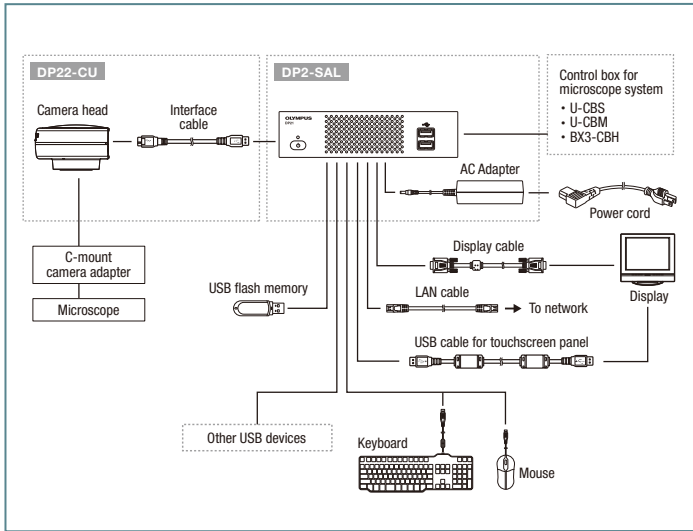

DP22 PC configuration system diagram

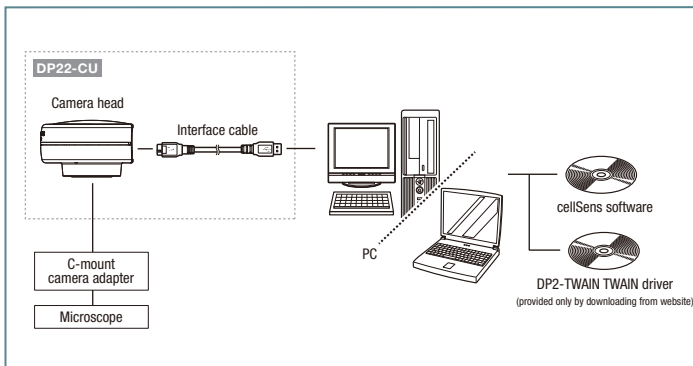

DP22 Specification

Type	Single chip color CCD camera
Imaging sensor	Size: 1/1.8 inch color CCD
	Effective pixels: 2.83 million pixels (total pixels: 2.98 million pixels)
	Scanning method: Progressive scanning
	Color filter: RGB primary color on-chip filters
	Recording area: 7.08(H) × 5.31(V) mm, diagonal length 8.8 mm
	Maximum recorded pixels: 2.76 megapixels (1920 × 1440)
Mount	C-mount
Sensitivity	Equivalent to ISO200/400/800
Metering Area	Full image / 30% / 1%
Exposure control	Auto/Manual AE lock (enabled when Auto Exposure is selected) Exposure compensation : Area -2EV to +1EV, +side:1/6EV step, - side:1/3EV step (enables when Auto Exposure is selected.)
Exposure time	Auto: 1/20,000s to 2s Manual: 1/20,000s to 8s
Camera I/F	USB3.0 Micro-B
Dimension	Camera Head: 77 (W) × 69.5 (D) × 42.5 (H) mm Control Unit: 180 (W) × 200 (D) × 47 (H) mm

	Stand-alone	PC connection
Image size	1920 × 1440	1920 × 1440
	1920 × 1080 (Full HD)	1920 × 1080 (Full HD)
	960 × 720	960 × 720
	Video recording pixels: 960 × 720 (AVI File)	
Live image display (frame rate)	25fps (1920 × 1440)	25fps (1920 × 1440)
	25fps (960 × 720)	25fps (960 × 720)
	30fps (1920 × 1080)	28fps (1920 × 1080)
Compatible image display	1920 × 1200 WUXGA	
	1920 × 1080 Full HD	
	1680 × 1050 WSXGA+	
	1600 × 1200 UXGA	
	1280 × 1024 SXGA	
	1280 × 960 QVGA	
	1280 × 854 WXGA	
	1280 × 768 WXGA	
	1024 × 768 XGA	
	1024 × 600 WSVGA	
800 × 480 WVGA		
Storage media	USB flash memory, USB-HDD	—
Controller interface	Camera I/F: USB 3.0 Type-A	USB3.0 (+5V / 900mA power output)
	Display output: DVI-I (Digital/Analog RGB)	
	I/F: USB 2.0 × 4, USB3.0 × 1	
	Wired LAN: 100Base-TX/10Base-T	
	Serial port: RS-232C D-Sub 9pin	
Audio: Mic in, Line out"		
Scale display	Scale view & burn in can be selected	According to cellSens* specifications
	Available microscope total magnification: 0.01× to 9999.99× Up to 28 total magnifications can be memorized	
	Measuring functions	Distance of 2 Points, 3 Points Circle, Distance between 2 Circle Centers, 3 Points Angle, 4 Points Angle, Perpendiculars, Polygon Area, Boundary Length, Distance of Parallel Lines, XY Distance, Count, Poly Line, and Cross Line

* cellSens software is not for clinical diagnostic use.



Wolf Laboratories Limited

www.wolflabs.co.uk

Wolflabs

Tel: 01759 301142

Fax: 01759 301143

sales@wolflabs.co.uk



Use the above details to contact us if this literature doesn't answer all your questions.

Pricing on any accessories shown can be found by keying the part number into the search box on our website.

The specifications listed in this brochure are subject to change by the manufacturer and therefore cannot be guaranteed to be correct. If there are aspects of the specification that must be guaranteed, please provide these to our sales team so that details can be confirmed.

