



Frontier™ 5706

Multi Centrifuge



Reliable and Compact Multi-Function Centrifuge For Standard Life Science Separation Applications

Frontier™ 5706 is a small benchtop multi-function centrifuge ideal for a multitude of spin-down applications. Characterized by reliability, various safety features, the ability to accommodate test tubes of various sizes and intuitive operation, Frontier 5706 was built to meet the basic need for liquid separation in the life sciences.

Standard Features Include:

- **Extremely Simple and Intuitive Operation**—With an easy-to-turn control knob, a large LCD display and the capabilities to set and view both speed in rpm and g-force, obtain precise results and enhanced functionality from this easy-to-use centrifuge.
- **Compatibility with Test Tubes of Various Sizes**—Frontier 5706 can accommodate all standard tube sizes from 1.5 mL to 50 mL, providing centrifugation for a wide variety of applications. It also has a large capacity, and can hold six 50 mL tubes and twelve 15 mL tubes during one process.
- **Several Safety Features that Protect Against Injury**—Among Frontier 5706's safety attributes are a sturdy mechanical lid with locking system and a rotor imbalance sensor that stops the centrifuge if the rotors become imbalanced or sudden shock occurs, protecting the operator from being injured by the high-speed spinning rotors.

Frontier™ 5706 Multi Centrifuge

Model	FC5706	
Speed Range	200 rpm – 6000 rpm; 50 rpm/increments	
Maximum RCF	4427 x g; 10 x g/set	
Maximum Capacity (Rotor)	6 x 50 mL	
Cooling	Air Cooled	
Running Time	10 sec to 99 hr 99 min 99 sec or Continuous	
Noise Level (Depending on the Rotor)	≤ 60 +2 dB(A)	
AC Power	230 V/50 – 60 Hz	120 V/50 – 60 Hz
Voltage Fluctuation	± 10%	± 10%
Current Consumption	0.55 A	1.1 A
Power Consumption	100 W	100 W
Dimensions (W x D x H)	291 x 392 x 266 mm	
Net Weight (Without Rotor)	10.5 kg	
Shipping Dimensions (W x D x H)	400 x 545 x 410 mm	
Shipping Weight (Without Rotor)	15 kg	

Approvals

- **Product Safety:** EN 61010-1:2010, EN 61010-2-020:2006
- **Electromagnetic Compatibility:** EN 61326-1:2006, FCC Part 15 Class B

Dimensions

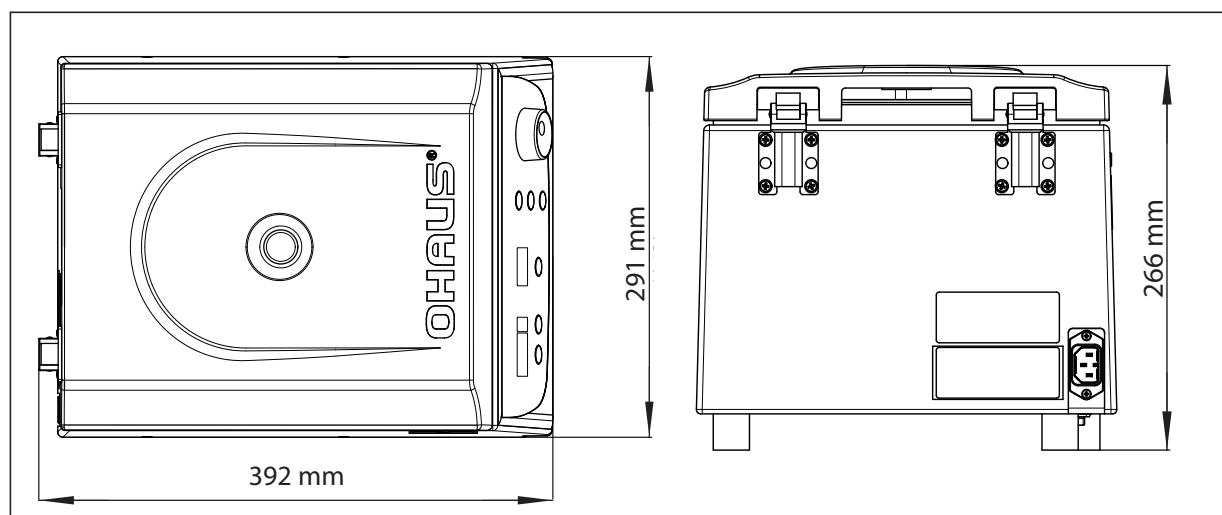





Frontier™ 5706 Rotors and Adapters









Rotors and Adapters that Expand the Versatility of Frontier FC5706

Various rotors and tube adapters provide FC5706 with the ability to hold tubes of different sizes and capacities.

				
Item	Angle Rotor, 12 × 15 mL	7mL Tube Adapter	5mL Tube Adapter	1.5 mL/2.0 mL Tube Adapter
Item Number	30130877	30130889	30130890	30130886
Compatible Tubes	15 mL	7 mL	5 mL	1.5mL / 2.0mL
Maximum Number of Tubes	12	12	12	12
Max. RPM	6000 rpm	6000 rpm	6000 rpm	6000 rpm
Max. RCF	4427 × g	4265 × g	3621 × g	3058 × g
Radius	110 mm	106 mm	90 mm	76 mm
Type	Angle Rotor ∠32°		—	
Rotor Material	PP ¹		—	

Frontier™ 5706 Rotors and Adapters

					
Item	Angle Rotor, 6 × 50 mL	30 mL Tube Adapter	16 mL Tube Adapter	15 mL Tube Adapter	15 mL RB/ Falcon Tube Adapter
Item Number	30130878	30130891	30130892	30130893	30130894
Compatible Tubes	50 mL	30 mL	16 mL	15 mL	15 mL RB/Falcon
Maximum Number of Tubes	6	6	6	6	6
Max. RPM	6000 rpm	6000 rpm	6000 rpm	6000 rpm	6000 rpm
Max. RCF	4427 × g	4306 × g	4145 × g	4225 × g	4185 × g
Radius	110 mm	107 mm	103 mm	105 mm	104 mm
Type	Angle Rotor ∠40°				
Rotor Material	PP ¹				

	
Item	Swing Out Rotor, 6 × 5 mL
Item Number	30130880
Compatible Tubes	5 mL
Maximum Number of Tubes	6
Max. RPM	6000 rpm
Max. RCF	1878 × g
Radius	105 mm
Type	Swing Out Rotor
Rotor Material	Aluminium

	
Item	Replaceable Buckets, For Swing Out Rotor (2 PCS/Package)
Item Number	30130895

Notes:

1. PP: Polypropylene



FRONTIER™ 5000

Rotor Guide



Offering Flexibility to Maximize Sample Preparation

- Choose from a range of rotors to be used with Frontier centrifuges to match capacities and flexibility required for your basic to high-performance sample preparation needs
- Designed with usability in mind, the Frontier rotors can be effortlessly installed or removed in a few quick and simple steps, and users have easy access to the samples
- The sturdy rotors are constructed of high-quality materials, built to last through demanding workflows from autoclave sterilization to sub-zero temperature
- OHAUS Frontier centrifuges are reliable, versatile and ideal for numerous laboratory applications
- Features include small to medium capacity, various speed ranges and non-refrigerated or refrigerated options to suit all requirements

Ingeniously Practical

Frontier™ 5000 Series

Powerful and Versatile Centrifuges for Virtually Every Lab Application

- The intuitive design of the centrifuges & accessories enable easy access to parameter settings, and quick rotation between applications.
- Our multi-purpose centrifuges offer a high-speed centrifuge platform which can be customized to fit workflow needs using a wide variety of rotors and accessories.
- The performance of these centrifuges is propelled by German engineering, and high-quality components for reliable use.



Model	Item No.	Voltage	Speed Range	Temp. Range	Max. g-force	Max. Capacity	Product Dimensions/Weight	Shipping Dimensions/Weight
FC5706	30130875	230V	200 - 6,000 rpm	Air Cooled	4,427 xg	6 x 50 ml	390 x 290 x 260 mm/10 kg	540 x 400 x 380 mm/14 kg
FC5707*	30393189	100-230V	200 - 6,800 rpm	Air Cooled	4,445 xg	8 x 15 ml	277 x 356 x 236 mm/10 kg	370 x 470 x 340 mm/11,5 kg
FC5513	30393187	230V	200 - 13,500 rpm	Air Cooled	17,317 xg	24 x 1.5/2.0 ml	277 x 356 x 236 mm/12,6 kg	370 x 470 x 340 mm/14,0 kg
	30370691*							
FC5515	30130866	230V	200 - 15,000 rpm	Air Cooled	21,953 xg	44 x 1.5/2.0 ml	390 x 280 x 290 mm/17 kg	540 x 400 x 380 mm/20 kg
FC5515R	30130868	230V	200 - 15,000 rpm	-20°C to 40°C	21,953 xg	44 x 1.5/2.0 ml	560 x 280 x 290 mm/35 kg	660 x 400 x 520 mm/44 kg
FC5714	30314810	230V	200 - 14,000 rpm	Air Cooled	18,624 xg	4 x 100 ml	490 x 360 x 330 mm/30 kg	580 x 490 x 280 mm/32,5 kg
FC5718	30314812	230V	200 - 18,000 rpm	Air Cooled	23,542 xg	4 x 100 ml	490 x 400 x 490 mm/43 kg	650 x 490 x 520 mm/53 kg
FC5718R	30314814	230V	200 - 18,000 rpm	-20°C to 40°C	23,542 xg	4 x 100 ml	730 x 400 x 350 mm/60 kg	840 x 640 x 590 mm/77 kg
FC5816	30314816	230V	200 - 15,000 rpm	Air Cooled	21,379 xg	6 x 250 ml	530 x 440 x 350 mm/52 kg	670 x 550 x 530 mm/56 kg
FC5816R	30314818	230V	200 - 16,000 rpm	-20°C to 40°C	24,325 xg	6 x 250 ml	530 x 720 x 350 mm/77 kg	840 x 640 x 590 mm/87 kg

*Rotor Included

Rotors for Frontier FC5706



Angle Rotor 12 x 15 ml	
Item No.	30130877
Rotor Capacity	12 x 15 ml
Rotor Type	Angle, 32°
Permissible Net Weight	300 g
Lowest Temperature	n/a

Accessory Specifications	n/a			
Accessory Item No.	n/a	30130886	30130889	30130890
Accessory Type	n/a	Adapter		
Max. RPM	6,000			
Max. RCF	4,427 x g	3,058 x g	4,265 x g	3,621 x g
Tube Specifications				
Tube Type	Round Bottom/Falcon	Micro Tube	Round bottom	
Tube volume	15 ml	1.5/2.0 ml	7 ml	5 ml
Tubes per Rotor	12			
Max. Tube Diameter (mm)	17	11	13.5	
Tube Height (mm)	121	42	95/115	62/90



Angle Rotor 6 x 50 ml	
Item No.	30130878
Rotor Capacity	6 x 50 ml
Rotor Type	Angle, 40°
Permissible Net Weight	432 g
Lowest Temperature	n/a

Accessory Specifications	n/a				
Accessory Item No.	n/a	30130891	30130892	30130893	30130894
Accessory Type	n/a	Adapter			
Max. RPM	6,000				
Max. RCF	4,427 x g	4,306 x g	4,145 x g	4,225 x g	4,185 x g
Tube Specifications					
Tube Type	Round Bottom/Falcon	Round Bottom			Round Bottom/Falcon
Tube Volume	50 ml	30 ml	16 ml	15 ml	
Tubes per Rotor	6				
Max. Tube Diameter (mm)	29	26	18	17	
Tube Height (mm)	116	100	100/105		120



Swing Out Rotor 6 x 5 ml

Item No.	30130880
Rotor Capacity	6 x 5 ml
Rotor Type	Swing Out, 0-90°
Permissible Net Weight	240 g
Lowest Temperature	n/a

Accessory Specifications



Accessory Item No.	30130895
Accessory Type	Bucket
Max. RPM	4,000
Max. RCF	1,878 x g

Tube Specifications



Tube Type	Round Bottom
Tube volume	5 ml
Tubes per Rotor	6
Max. Tube Diameter (mm)	14
Tube Height (mm)	75

Item Number









Accessories

30130895	Buckets, For 30130880 x2
----------	--------------------------

Rotors for Frontier FC5707







Angle Rotor 8 x 15 ml	
Item No.	30472305
Rotor Capacity	8 x 15 ml
Rotor Type	Angle, 32°
Permissible Net Weight	200 g
Lowest Temperature	n/a

Accessory Specifications	n/a	n/a			
Accessory Item No.	n/a	n/a	30130886	30130889	30130890
Accessory Type	n/a	n/a	Adapter		
Max. RPM	6,800				
Max. RCF	4,445 x g		2,894 x g	4,290 x g	3,618 x g
Tube Specifications					
Tube Type	Round Bottom	Conical	Micro Tube	Round Bottom	
Tube Volume	15 ml		1.5/2.0 ml	7 ml	5 ml
Tubes per Rotor	8	4	8		
Max. Tube Diameter (mm)	17		11	13.5	
Tube Height (mm)	95/100	121	42	95/115	62/90

Rotors for Frontier FC5513







Angle Rotor 24 × 1.5/2.0 ml	
Item No.	30472301
Rotor Capacity	24 × 1.5/2.0 ml
Rotor Type	Angle, 45°
Permissible Net Weight	82 g
Lowest Temperature	n/a

Accessory Specifications	n/a		
Accessory Item No.	n/a	30130884	30130885
Accessory Type	n/a	Adapter	
Max. RPM	13,500		
Max. RCF	17,317 x g	n/a	2,716 x g
Tube Specifications			
Tube Type	Microtube		
Tube volume	1.5/2.0 ml	0.2/0.4 ml	0.5 ml
Tubes per Rotor	24	24	
Max. Tube Diameter (mm)	11	6	8
Tube Height (mm)	40	20	30



Angle Rotor 24 × 1.5/2.0 ml Sealable	
Item No.	30472302
Rotor Capacity	24 × 1.5/2.0 ml
Rotor Type	Angle, 45°
Permissible Net Weight	82 g
Lowest Temperature	n/a

Accessory Specifications	n/a		
Accessory Item No.	n/a	30130884	30130885
Accessory Type	n/a	Adapter	
Max. RPM	13,500		
Max. RCF	17,317 x g	15,076 x g	16,706 x g
Tube Specifications			
Tube Type	Microtube		
Tube volume	1.5/2.0 ml	0.2/0.4 ml	0.5 ml
Tubes per Rotor	24		
Max. Tube Diameter (mm)	11	6	8
Tube Height (mm)	40	20	30



Angle Rotor 18 × 2.0 ml Spin Column	
Item No.	30472303
Rotor Capacity	18 × 2.0 ml
Rotor Type	Angle, 45°
Permissible Net Weight	68 g
Lowest Temperature	n/a

Tube Specifications
Tube Type
Tube volume
Tubes per Rotor
Max. Tube Diameter (mm)
Tube Height (mm)

Microtube
2 ml
18
11
40

*No Adapters







Hematocrit Rotor 24 × Capillaries	
Item No.	30472304
Rotor Capacity	24 × Capillaries
Rotor Type	Hematocrit, 90°
Permissible Net Weight	4.8 g
Lowest Temperature	n/a

*No Adapters

Rotors for Frontier FC5515 and FC5515-R







Angle Rotor 24 × 1.5/2.0 ml	
Item No.	30130870
Rotor Capacity	24 x 1.5/2.0 ml
Rotor Type	Angle, 45°
Permissible Net Weight	82 g
Lowest Temperature	+5 °C

Accessory Specifications	n/a		
Accessory Item No.	n/a	30130884	30130885
Accessory Type	n/a	Adapter	
Max. RPM	15,200		
Max. RCF	21,953 x g	19,145 x g	20,932 x g
Tube Specifications			
Tube Type	Microtube	Microtube	
Tube volume	1.5/2.0 ml	0.2 ml	0.5 ml
Tubes per Rotor	24		
Max. Tube Diameter (mm)	11	6	8
Tube Height (mm)	40	20	30







Angle Rotor 24 × 1.5/2.0 ml Sealable	
Item No.	30130871
Rotor Capacity	24 x 1.5/2.0 ml
Rotor Type	Angle, 45°
Permissible Net Weight	82 g
Lowest Temperatures	+5 °C

Accessory Specifications	n/a		
Accessory Item No.	n/a	30130884	30130885
Accessory Type	n/a	Adapter	
Max. RPM	15,200		
Max. RCF	21,953 x g	19,165 x g	20,932 x g
Tube Specifications			
Tube Type	Microtube	Microtube	
Tube volume	1.5/2.0 ml	0.2 ml	0.5 ml
Tubes per Rotor	24		
Max. Tube Diameter (mm)	11	6	8
Tube Height (mm)	40	20	30









Angle Rotor 30 × 1.5/2.0 ml Sealable	
Item No.	30130872
Rotor Capacity	30 x 1.5/2.0 ml
Rotor Type	Angle, 45°
Permissible Net Weight	102 g
Lowest Temperatures	+6 °C

Accessory Specifications	n/a		
Accessory Item No.	n/a	30130884	30130885
Accessory Type	n/a	Adapter	
Max. RPM	13,500		
Max. RCF	19,150 x g	16,933 x g	18,344 x g
Tube Specifications			
Tube Type	Microtube		
Tube volume	1.5/2.0 ml	0.2/0.4 ml	0.5 ml
Tubes per Rotor	30		
Max. Tube Diameter (mm)	11	6	8
Tube Height (mm)	40	20	30



Angle Rotor 12 × 5 ml Sealable	
Item No.	30130873
Rotor Capacity	12 x 5 ml
Rotor Type	Angle, 45°
Permissible Net Weight	165 g
Lowest Temperatures	+4 °C

Accessory Specifications	n/a			
Accessory Item No.	n/a	30130886	30130887	30130888
Accessory Type	n/a	Adapter		
Max. RPM	14,500			
Max. RCF	19,978 x g	16,452 x g	17,158 x g	17,628 x g
Tube Specifications				
Tube Type	Microtube		Cryo Tube	
Tube volume	5 ml	1.5/2.0 ml	1.0 ml	1.8 ml
Tubes per Rotor	12			
Max. Diameter (mm)	17	11	12.6	
Tube Height (mm)	60	42	41	48







Angle Rotor 4 x 8 Place PCR Stripes	
Item No.	30130874
Rotor Capacity	4 x 8 Place PCR Stripes
Rotor Type	Angle, 45°
Permissible Net Weight	14 g
Lowest Temperatures	+5 °C

*No Adapters



Angle Rotor 44 x 1.5/2.0 ml	
Item No.	30130879
Rotor Capacity	44 x 1.5/2.0 ml
Rotor Type	Angle, 32°/55°
Permissible Net Weight	150 g
Lowest Temperatures	+6 °C

Accessory Specifications	n/a		
Accessory Item No.	n/a	30130884	30130885
Accessory Type	n/a	Adapter	
Max. RPM	13,500		
Max. RCF	17,317 x g	15,668 x g	17,111 x g
Tube Specifications			
Tube Type	Microtube		
Tube volume	1.5/2.0 ml	0.2/0.4 ml	0.5 ml
Tubes per Rotor	44		
Max. Tube Diameter (mm)	11	6	8
Tube Height (mm)	40	20	30































Rotor, Angle, 24 x Capillaries	
Item No.	30130881
Rotor Capacity	24 x Capillaries
Rotor Type	Angle, 90°
Permissible Net Weight	4.8 g
Lowest Temperatures	n/a







*No Adapters

Rotors for Frontier FC5714

	Swing Out Rotor 4 x 100 ml	
	Item No.	30314822
	Rotor Capacity	4 x 100 ml
	Rotor Type	Swing Out, 0-90°
	Permissible Net Weight	4 x 340 g
Lowest Temperature	n/a	

Accessory Specifications							
Accessory Item No.	30314842	30314843	30314844	30314845	30314846	30314847	30314848
Accessory Type	Rack						
Max. RPM	4,500						
Max. RCF	3,192 x g		3,214 x g		3,192 x g	3,237 x g	3,124 x g
Tube Specifications							
Tube Type	Round Bottom				Falcon	Skirted Concial	
Tube volume	100 ml	85 ml	50 ml			30 ml	
Tubes per Rotor	4						
Max. Tube Diameter (mm)	46	38	34	29			25
Tube Height (mm)	90/108	92/118		90/108	116		95/105

Accessory Specifications							
Accessory Item No.	30314849	30314850	30314851	30314852	30314853	30314854	30314855
Accessory Type	Rack						
Max. RPM	4,500						
Max. RCF	3259	3350	3282		3214	2241	3169
Tube Specifications							
Tube Type	Round Bottom	Falcon	Skirted Concial	Round Bottom		Micro Tube	Flat Bottom
Tube volume	25 ml	15 ml			5-7 ml	1.5 ml	4.5 ml
Tubes per Rotor	4	8	4	28	36	40	36
Max. Tube Diameter (mm)	25	17			13	11	12
Tube Height (mm)	95/105	120		90/108	75/100	42	75/100

Accessory Specifications			
Accessory Item No.	30314856	30314857	30314858
Accessory Type	Rack		
Max. RPM	4,500		
Max. RCF	2,626 x g	3,214 x g	3,237 x g
Tube Specifications			
Tube Type	Round Bottom	Vacutainer	Sarstedt
Tube volume	5-7 ml		4-10 ml
Tubes per Rotor	28		
Max. Tube Diameter (mm)	13		16
Tube Height (mm)	65/80	75/100	







Swing Out Rotor 4 x 100 ml Sealable	
Item No.	30314823
Rotor Capacity	4 x 100 ml
Rotor Type	Swing Out, 0-90°
Permissible Net Weight	4 x 465 g
Lowest Temperature	n/a

Accessory Specifications							
Accessory Item No.	30314860	30314861	30314862	30314863	30314864	30314865	30314866
Accessory Type	Bucket		Screw Cap	O-Ring	Rack		
Max. RPM	4,000						
Max. RCF	2,418 x g		N/A		2,350 x g	2,384 x g	
Tube Specifications							
Tube Type	Round Bottom						
Tube volume	100 ml					85 ml	50 ml
Tubes per Rotor	n/a				4		
Max. Tube Diameter (mm)	n/a				40	38	34
Tube Height (mm)	n/a				90/108		92/118

Accessories						
Items	Bucket, 100ml w/o Cap, 2/pk	Bucket, 100ml w/Cap, Sealable, 2/pk	Screw Cap, 100ml Bucket, Sealable, 2/pk	O-ring, 100ml Bucket, Sealable, 10/pk	N/A	



Accessory Specifications							
Accessory Item No.	30314867	30314868	30314869	30314870	30314871	30314872	30314873
Accessory Type	Rack						
Max. RPM	4,000						
Max. RCF	2,383 x g	2,400 x g	2,366 x g	2,230 x g	2,383 x g	2,400 x g	
Tube Specifications							
Tube Type	Round Bottom	Falcon	Skirted Conical		Round Bottom	Falcon	
Tube volume	50 ml			30 ml	25 ml	15 ml	
Tubes per Rotor	4					8	
Max. Tube Diameter (mm)	29			25		17	
Tube Height (mm)	90/113	116		95/105	95/110	120	

Accessory Specifications							
Accessory Item No.	30314874	30314875	30314876	30314877	30314878	30314879	30314880
Accessory Type	Rack						
Max. RPM	4,000						
Max. RCF	2,383 x g						
Tube Specifications							
Tube Type	Skirted Conical	Round Bottom		Micro Tube	Sarstedt	Round Bottom	Vacutainer
Tube volume	15 ml		5-7 ml	1.5 ml	10 ml	5-7 ml	10 ml
Tubes per Rotor	8	16	28	20	12	16	
Max. Tube Diameter (mm)	17		13	11	17	13	17
Tube Height (mm)	120	90/108	75/100	42	85/100	75/100	75/101

Accessory Specifications		
Accessory Item No.	30314881	30314882
Accessory Type	Bucket	
Max. RPM	4,000	
Max. RCF	2,486 x g	
Tube Specifications		
Tube Type	Falcon	
Tube volume	50 ml	15 ml
Tubes per Rotor	8	12
Max. Tube Diameter (mm)	29	17
Tube Height (mm)	116	120

Accessories	
Items	Bucket, 3x15ml D17mm FA, w/Rack, 2/pk

	Swing Out Rotor 2 x 3 MTP w/bucket	
	Item No.	30314824
	Rotor Capacity	2 x 3 MTP
	Rotor Type	Swing Out, 0-90°
	Permissible Net Weight	2 x 310 g
	Lowest Temperature	n/a

Accessory Specifications		
Accessory Item No.	30314890	30314891
Accessory Type	Bucket	Adapter
Max. RPM	4,500	
Max. RCF	2,716 x g	
Tube Specifications	n/a	
Tube Type	Microplate	Microtube
Tube volume	MTP	1.5/2.0 ml
Tubes per Rotor	6 Standard Microplates or 2 Deepwell Plates	96
Max. Tube Diameter (mm)	87 x 128	11
Tube Height (mm)	51	42

Accessories	
Items	Bucket, 3xMTP, 2/pk



Angle Rotor 6 x 50 ml	
Item No.	30314830
Rotor Capacity	6 x 50 ml
Rotor Type	Angle, 40°
Permissible Net Weight	6 x 72 g
Lowest Temperature	n/a

Accessory Specifications	n/a							
Accessory Item No.	n/a	30130886	30130889	30130890	30130891	30130892	30130893	30130894
Accessory Type	n/a	Adapter						
Max. RPM	6,000							
Max. RCF	4,427 x g	2,696 x g	4,105 x g	3,340 x g	4,306 x g	4,145 x g	4,266 x g	
Tube Specifications								
Tube Type	Round Bottom/Falcon	Micro Tube	Round Bottom				Round Bottom/Falcon	
Tube volume	50 ml	1.5/2.0 ml	7 ml	5 ml	30 ml	16 ml	15 ml	
Tubes per Rotor	6							
Max. Tube Diameter (mm)	29	11	13.5		26	18	17	
Tube Height (mm)	116	42	100	65/75	100	100/105		120



Angle Rotor 30 x 15 ml	
Item No.	30314832
Rotor Capacity	30 x 15 ml
Rotor Type	Angle, 35°
Permissible Net Weight	30 x 32 g
Lowest Temperature	n/a

Accessory Specifications	n/a			
Accessory Item No.	n/a	30130886	30130889	30130890
Accessory Type	n/a	Adapter		
Max. RPM	4,500			
Max. RCF	2,830 x g	2,038 x g	2,762 x g	2,377 x g
Tube Specifications				
Tube Type	Round Bottom/Falcon	Micro Tube	Round Bottom	
Tube Volume	15 ml	1.5/2.0 ml	7 ml	5 ml
Tubes per Rotor	30			
Max. Tube Diameter (mm)	17	11	13.5	
Tube Height (mm)	95/115	42	100	65/75



Angle Rotor 12 × 15 ml	
Item No.	3014834
Rotor Capacity	12 x 15 ml
Rotor Type	Angle, 32°
Permissible Net Weight	12 x 25 g
Lowest Temperature	n/a

Accessory Specifications	n/a			
Accessory Item No.	n/a	30130886	30130889	30130890
Accessory Type	n/a	Adapter		
Max. RPM	6,000			
Max. RCF	4,427 x g	3,059 x g	4,266 x g	3,662 x g
Tube Specifications				
Tube Type	Round Bottom/Falcon	Micro Tube	Round Bottom	
Tube Volume	15 ml	1.5/2.0 ml	7 ml	5 ml
Tubes per Rotor	12			
Max. Tube Diameter (mm)	17	11	13.5	
Tube Height (mm)	121	42	100	65/75







Angle Rotor 30 × 1.5/2.0 ml Sealable	
Item No.	3014836
Rotor Capacity	30 x 1.5/2.0 ml
Rotor Type	Angle, 45°
Permissible Net Weight	30 x 3.4 g
Lowest Temperature	n/a

Accessory Specifications	n/a			
Accessory Item No.	n/a	30130884	30130885	
Accessory Type	n/a	Adapter		
Max. RPM	12,000			
Max. RCF	15,131 x g	13,521 x g	14,648 x g	
Tube Specifications				
Tube Type	Microtube			
Tube volume	1.5/2.0 ml	0.2/0.4 ml	0.5 ml	
Tubes per Rotor	30			
Max. Tube Diameter (mm)	11	6	8	
Tube Height (mm)	40	20	30	







Angle Rotor 24 x 1.5/2.0 ml	
Item No.	30314838
Rotor Capacity	24 x 1.5/2.0 ml
Rotor Type	Angle, 45°
Permissible Net Weight	24 x 3.4 g
Lowest Temperature	n/a

Accessory Specifications	n/a		
Accessory Item No.	n/a	30130884	30130885
Accessory Type	n/a	Adapter	
Max. RPM	14,000		
Max. RCF	18,624 x g	16,433 x g	17,967 x g
Tube Specifications			
Tube Type	Microtube		
Tube volume	1.5/2.0 ml	0.2/0.4 ml	0.5 ml
Tubes per Rotor	24		
Max. Tube Diameter (mm)	11	6	8
Tube Height (mm)	40	20	30









Angle Rotor 24 x 1.5/2.0 ml Sealable	
Item No.	30304361
Rotor Capacity	24 x 1.5/2.0 ml
Rotor Type	Angle, 45°
Permissible Net Weight	24 x 3.4 g
Lowest Temperature	n/a















Accessory Specifications	n/a		
Accessory Item No.	n/a	30130884	30130885
Accessory Type	n/a	Adapter	
Max. RPM	14,000		
Max. RCF	18,624 x g	16,433 x g	17,967 x g
Tube Specifications			
Tube Type	Microtube		
Tube volume	1.5/2.0 ml	0.2/0.4 ml	0.5 ml
Tubes per Rotor	24		
Max. Tube Diameter (mm)	11	6	8
Tube Height (mm)	40	20	30















Rotors for Frontier FC5718 and FC5718R







	Angle Rotor 24 × 1.5/2.0 ml Sealable	
	Item No.	30304361
	Rotor Capacity	24 x 1.5/2.0 ml
	Rotor Type	Angle, 45°
	Permissible Net Weight	24 x 3.4 g
	Lowest Temperatures	6 °C

Accessory Specifications	n/a		
Accessory Item No.	n/a	30130884	30130885
Accessory Type	n/a	Adapter	
Max. RPM (FC5718/FC5718R approved)	14,000/15,000		
Max. RCF	18,624/21,379 x g	16,433/18,863 x g	17,967/20,624 x g
Tube Specifications			
Tube Type	Micro Tube		
Tube volume	1.5/2.0 ml	0.2/0.4 ml	0.5 ml
Tubes per Rotor	24		
Max. Tube Diameter (mm)	11	6	8
Tube Height (mm)	40	20	30











	Swing Out Rotor 4 × 100 ml	
	Item No.	30314822
	Rotor Capacity	4 x 100 ml
	Rotor Type	Swing Out, 0-90°
	Permissible Net Weight	4 x 340 g
	Lowest Temperatures	-7 °C

Accessory Specifications							
Accessory Item No.	30314842	30314843	30314844	30314845	30314846	30314847	30314848
Accessory Type	Rack						
Max. RPM	4,500						
Max. RCF	3,192 x g		3,214 x g		3,192 x g	3,237 x g	3,213 x g
Tube Specifications							
Tube Type	Round Bottom				Falcon	Skirted Conical	
Tube volume	100 ml	85 ml	50 ml				
Tubes per Rotor	4						
Max. Tube Diameter (mm)	46	38	34	29		25	
Tube Height (mm)	90/108	92/118		90/118	116		95/105















Accessory Specifications							
Accessory Item No.	30314849	30314850	30314851	30314852	30314853	30314854	30314855
Accessory Type	Rack						
Max. RPM	4,500						
Max. RCF	3,259 x g	3,350 x g	3,282 x g		3,214 x g	2,241 x g	3,169 x g
Tube Specifications							
Tube Type	Round Bottom	Falcon	Skirted Concial	Round Bottom		Micro Tube	Flat Bottom
Tube volume	25 ml	15 ml			5-7 ml	1.5 ml	4.5 ml
Tubes per Rotor	4	8	4	28	36	40	36
Max. Tube Diameter (mm)	17		13		11	12	13
Tube Height (mm)	95/105	120		90/108	75/100	42	75/100















Accessory Specifications			
Accessory Item No.	30314856	30314857	30314858
Accessory Type	Rack		
Max. RPM	4,500		
Max. RCF	2,626 x g	3,214 x g	3,237 x g
Tube Specifications			
Tube Type	Round Bottom	Vacutainer	Sarstedt
Tube Volume	5-7 ml		4-10 ml
Tubes per Rotor	28		20
Max. Tube Diameter (mm)	13		16
Tube Height (mm)	65/80	75/100	





	Swing Out Rotor 4 x 100 ml Sealable	
	Item No.	30314823
	Rotor Capacity	4 x 100 ml
	Rotor Type	Swing Out, 0-90°
	Permissible Net Weight	4 x 465 g
	Lowest Temperatures	-3 °C

Accessory Specifications							
Accessory Item No.	30314860	30314861	30314862	30314863	30314864	30314865	30314866
Accessory Type	Bucket		Screw Cap	O-Ring	Rack		
Max. RPM	5,000/5,000						
Max. RCF	3,779 x g	n/a			3,672 x g	3,725 x g	
Tube Specifications							
Tube Type	Round Bottom						
Tube volume	100 ml			n/a		85 ml	50 ml
Tubes per Rotor	4						
Max. Tube Diameter (mm)	n/a			40		38	34
Tube Height (mm)	n/a			90/108			92/118

Accessories						
Items	Bucket, 100ml w/o Cap, 2/pk	Bucket, 100ml w/Cap, Sealable, 2/pk	Screw Cap, 100ml Bucket, Sealable, 2/pk	O-ring, 100ml Bucket, Sealable, 10/pk	n/a	



Accessory Specifications							
Accessory Item No.	30314867	30314868	30314869	30314870	30314871	30314872	30314873
Accessory Type	Rack						
Max. RPM	5,000/5,000						
Max. RCF	3,725 x g	3,751 x g	3,699 x g	3,486 x g	3,725 x g	3,752 x g	
Tube Specifications							
Tube Type	Round Bottom	Falcon	Skirted Conical		Round Bottom	Falcon	
Tube volume	50 ml			30 ml	25 ml	15 ml	
Tubes per Rotor	4					120	
Max. Tube Diameter (mm)	29			25		17	
Tube Height (mm)	90/113	116		95/105	95/110	120	

Accessory Specifications							
Accessory Item No.	30314874	30314875	30314876	30314877	30314878	30314879	30314880
Accessory Type	Rack						
Max. RPM	5,000/5,000						
Max. RCF	3,725 x g						
Tube Specifications							
Tube Type	Skirted Conical	Round Bottom		Micro Tube	Sarstedt	Round Bottom	Vacutainer
Tube volume	15 ml		5-7 ml	1.5 ml	10 ml	5-7 ml	10 ml
Tubes per Rotor	8	16	28	20	12	16	
Max. Tube Diameter (mm)	17		13	11	17	13	17
Tube Height (mm)	120	90/108	75/100	42	85/100	75/100	

Accessory Specifications		
Accessory Item No.	30314881	30314882
Accessory Type	Bucket	
Max. RPM	5,000/5,000	
Max. RCF	3,885 x g	
Tube Specifications		
Tube Type	Falcon	
Tube volume	50 ml	15 ml
Tubes per Rotor	8	12
Max. Tube Diameter (mm)	29	17
Tube Height (mm)	116	120















Accessories	
Items	Bucket, 2x50ml D29mm FA, w/Rack, 2/pk Bucket, 3x15ml D17mm FA, w/Rack, 2/pk

	Swing Out Rotor 2 x 3 MTP w/bucket	
	Item No.	30314824
	Rotor Capacity	2 x 3 MTP
	Rotor Type	Swing Out, 0-90°
	Permissible Net Weight	2 x 310 g
	Lowest Temperatures	-6 °C

Accessory Specifications		
Accessory Item No.	30314890	30314891
Accessory Type	Bucket	Adapter
Max. RPM	4,500	
Max. RCF	2,716 x g	
Tube Specifications	n/a	
Tube Type	Microplate	Microtube
Tube volume	MTP	1.5/2.0 ml
Tubes per Rotor	6 Standard Microplates or 2 Deepwell Plates	96
Max. Tube Diameter (mm)	87 x 128	11
Tube Height (mm)	51	42

Accessories		
Items	Bucket, 3xMTP, 2/pk	N/A

	Angle Rotor 6 x 85 ml	
	Item No.	30314825
	Rotor Capacity	6 x 85 ml
	Rotor Type	Angle, 25°
	Permissible Net Weight	6 x 140 g
	Lowest Temperatures	17 °C

Accessory Specifications	n/a							
Accessory Item No.	n/a	30314893	30314894	30314895	30314896	30314897	30314898	30314899
Accessory Type	n/a	Adapter						
Max. RPM (FC5718/FC5718R approved)	11,000/13,500							
Max. RCF	13,932/20,984 x g	12,985/19,557 x g		13,526/20,372 x g		12,579/18,946 x g	13,932/20,984 x g	12,850/19,354 x g
Tube Specifications								
Tube Type	Round Bottom			Falcon		Round Bottom		
Tube volume	85 ml	15 ml	30 ml	50 ml		15 ml	16 ml	
Tubes per Rotor	6						12	6
Max. Tube Diameter (mm)	38	17	25	29		17	18	
Tube Height (mm)	113	103/110	90/103	105	118	120	95/100	103/110



Angle Rotor 6 x 85 ml	
Item No.	30314826
Rotor Capacity	6 x 85 ml
Rotor Type	Angle, 38°
Permissible Net Weight	6 x 140 g
Lowest Temperatures	-5 °C

Accessory Specifications	n/a								
Accessory Item No.	n/a	30314893	30314894	30314895	30314896	30314897	30314898	30314899	
Accessory Type	n/a	Adapter							
Max. RPM (FC5718/FC5718R approved)	9,000/9,000								
Max. RCF	10,413 x g	9,598 x g	9,417 x g	9,870 x g	9,598 x g	9,417 x g	10,051 x g	9,417 x g	
Tube Specifications									
Tube Type	Round Bottom				Falcon		Round Bottom		
Tube volume	85 ml	15 ml	30 ml	50 ml		15 ml		16 ml	
Tubes per Rotor	6						12		6
Max. Tube Diameter (mm)	38	17	25	29		17		18	
Tube Height (mm)	113	103/110	90/103	105	118	120	95/100	103/110	



Angle Rotor 4 x 85 ml	
Item No.	30314827
Rotor Capacity	4 x 85 ml
Rotor Type	Angle, 30°
Permissible Net Weight	4 x 140 g
Lowest Temperatures	5 °C

Accessory Specifications	n/a								
Accessory Item No.	n/a	30314893	30314894	30314895	30314896	30314897	30314898	30314899	
Accessory Type	n/a	Adapter							
Max. RPM (FC5718/FC5718R approved)	12,000/12,000								
Max. RCF	14,809 x g	13,682 x g	13,521 x g	14,326 x g	13,843 x g	13,360 x g	12,073 x g	13,360 x g	
Tube Specifications									
Tube Type	Round Bottom				Falcon		Round Bottom		
Tube volume	85 ml	15 ml	30 ml	50 ml		15 ml		16 ml	
Tubes per Rotor	4						12		6
Max. Tube Diameter (mm)	38	17	25	29		17		18	
Tube Height (mm)	113	103/110	90/103	105	118	120	95/100	103/110	



Angle Rotor 10 x 50 ml	
Item No.	30314829
Rotor Capacity	10 x 50 ml
Rotor Type	Angle, 38°
Permissible Net Weight	10 x 74 g
Lowest Temperatures	9 °C

Accessory Specifications	n/a					
Accessory Item No.	n/a	30130886	30130889	30130890	30472300	30472307
Accessory Type	n/a	Adapter				
Max. RPM (FC5718/FC5718R approved)	7,500/7,500					
Max. RCF	8,174 x g	5,596 x g	7,671 x g	6,539 x g	7,860 x g	8,048 x g
Tube Specifications						
Tube Type	Falcon	Micro Tube	Round Bottom		Round bottom	Conical
Tube Volume	50 ml	1.5/2.0 ml	7 ml	5 ml	15 ml	
Tubes per Rotor	10					
Max. Tube Diameter (mm)	29	11	13.5		17	
Tube Height (mm)	118	42	100	100	97-123	120



Angle Rotor 6 x 50 ml	
Item No.	30314830
Rotor Capacity	6 x 50 ml
Rotor Type	Angle, 40°
Permissible Net Weight	6 x 72 g
Lowest Temperatures	-8 °C

Accessory Specifications	n/a							
Accessory Item No.	n/a	30130886	30130891	30130890	30130891	30130892	30130893	30130892
Accessory Type	n/a	Adapter						
Max. RPM (FC5718/FC5718R approved)	6,000/6,000							
Max. RCF	4,427 x g	2,696 x g	4,105 x g	3,340 x g	4,306 x g	4,145 x g	4,266 x g	
Tube Specifications								
Tube Type	Round Bottom/Falcon	Micro Tube	Round Bottom					
Tube volume	50 ml	15 ml	30 ml	50 ml		15 ml		16 ml
Tubes per Rotor	6						6	6
Max. Tube Diameter (mm)	29	11	13.5		26	17	18	
Tube Height (mm)	116	42	26	65/75	100	100/105		120



Angle Rotor 6 x 50 ml	
Item No.	30314831
Rotor Capacity	6 x 50 ml
Rotor Type	Angle, 26°
Permissible Net Weight	6 x 94 g
Lowest Temperatures	-5 °C

Accessory Specifications	n/a				
Accessory Item No.	n/a	30130891	30130892	30130893	30314892
Accessory Type	n/a	Adapter			
Max. RPM (FC5718/FC5718R approved)	12,000/12,000				
Max. RCF	13,522 x g	13,200 x g	12,717 x g	12,878 x g	12,395 x g
Tube Specifications					
Tube Type	Round Bottom				Falcon
Tube Volume	50 ml	30 ml	16 ml	15 ml	
Tubes per Rotor	6				
Max. Tube Diameter (mm)	29	26	18	17	17.5
Tube Height (mm)	95/115	100	100/105		116/125



Angle Rotor 30 x 15 ml	
Item No.	30314832
Rotor Capacity	30 x 15 ml
Rotor Type	Angle, 35°
Permissible Net Weight	30 x 32 g
Lowest Temperatures	-9 °C

Accessory Specifications	n/a			
Accessory Item No.	n/a	30130886	30130889	30130890
Accessory Type	n/a	Adapter		
Max. RPM (FC5718/FC5718R approved)	4,500/4,500			
Max. RCF	2,830 x g	2,038 x g	2,762 x g	2,377 x g
Tube Specifications				
Tube Type	Round Bottom/Falcon	Micro Tube	Round Bottom	
Tube Volume	15 ml	1.5/2.0 ml	7 ml	5 ml
Tubes per Rotor	30			
Max. Tube Diameter (mm)	17	11	13.5	
Tube Height (mm)	95/115	42	100	65/75









Angle Rotor 20 x 10 ml	
Item No.	30314833
Rotor Capacity	20 x 10 ml
Rotor Type	Angle, 30°
Permissible Net Weight	20 x 18 g
Lowest Temperatures	2 °C

*No Adapters







Angle Rotor 12 × 15 ml	
Item No.	30314834
Rotor Capacity	12 x 15 ml
Rotor Type	Angle, 32°
Permissible Net Weight	12 x 25 g
Lowest Temperatures	-11.5 °C

Accessory Specifications	n/a			
Accessory Item No.	n/a	30130886	30130889	30130890
Accessory Type	n/a	Adapter		
Max. RPM (FC5718/FC5718R approved)	6,000/6,000			
Max. RCF	4,427 x g	3,059 x g	4,266 x g	3,662 x g
Tube Specifications				
Tube Type	Round Bottom/Falcon	Micro Tube	Round Bottom	
Tube Volume	15 ml	1.5/2.0 ml	7 ml	5 ml
Tubes per Rotor	12			
Max. Tube Diameter (mm)	17	11	13.5	
Tube Height (mm)	121	42	100	65/75







Angle Rotor 44 × 1.5/2.0 ml	
Item No.	30314835
Rotor Capacity	44 x 1.5/2.0 ml
Rotor Type	Angle, 32°/55°
Permissible Net Weight	44 x 3.8 g
Lowest Temperatures	1 °C

Accessory Specifications	n/a		
Accessory Item No.	n/a	30130884	30130885
Accessory Type	n/a	Adapter	
Max. RPM (FC5718/FC5718R approved)	13,500/13,500		
Max. RCF	17,113 x g	15,687 x g	16,706 x g
Tube Specifications			
Tube Type	Micro Tube		
Tube volume	1.5/2.0 ml	0.2/0.4 ml	0.5 ml
Tubes per Rotor	44		
Max. Tube Diameter (mm)	11	6	8
Tube Height (mm)	40	20	30







Angle Rotor 30 × 1.5/2.0 ml Sealable	
Item No.	30314836
Rotor Capacity	30 x 1.5/2.0 ml
Rotor Type	Angle, 45°
Permissible Net Weight	30 x 3.4 g
Lowest Temperatures	9 °C

Accessory Specifications	n/a		
Accessory Item No.	n/a	30130884	30130885
Accessory Type	n/a	Adapter	
Max. RPM (FC5718/FC5718R approved)	13,000/14,000		
Max. RCF	17,758/20,595 x g	17,191/19,937 x g	15,869/18,404 x g
Tube Specifications			
Tube Type	Micro Tube		
Tube volume	1.5/2.0 ml	0.2/0.4 ml	0.5 ml
Tubes per Rotor	30		
Max. Tube Diameter (mm)	11	6	8
Tube Height (mm)	40	20	30



Angle Rotor 24 × 1.5/2.0 ml	
Item No.	30314838
Rotor Capacity	24 x 1.5/2.0 ml
Rotor Type	Angle, 45°
Permissible Net Weight	24 x 3.4 g
Lowest Temperatures	6 °C

Accessory Specifications	n/a		
Accessory Item No.	n/a	30130884	30130885
Accessory Type	n/a	Adapter	
Max. RPM (FC5718/FC5718R approved)	14,000/15,000		
Max. RCF	18,624/21,379 x g	16,433/18,863 x g	17,967/20,624 x g
Tube Specifications			
Tube Type	Micro Tube		
Tube volume	1.5/2.0 ml	0.2/0.4 ml	0.5 ml
Tubes per Rotor	24		
Max. Tube Diameter (mm)	11	6	8
Tube Height (mm)	40	20	30



Angle Rotor 12 x 1.5/2.0 ml	
Item No.	30314839
Rotor Capacity	12 x 1.5/2.0 ml
Rotor Type	Angle, 40°
Permissible Net Weight	12 x 3.4 g
Lowest Temperatures	-2 °C

Accessory Specifications	n/a			
Accessory Item No.	n/a	30314900	30130885	30130884
Accessory Type	n/a	Adapter		
Max. RPM (FC5718/FC5718R approved)	18,000			
Max. RCF	23,542 x g	23,180 x g	20,282 x g	22,818 x g
Tube Specifications				
Tube Type	Microtube			
Tube Volume	2 ml	1.5 ml	0.5 ml	0.2/0.4 ml
Tubes per Rotor	12			
Max. Tube Diameter (mm)	11	11	8	6
Tube Height (mm)	40	42	30	20



Angle Rotor 64 x 0.5 ml	
Item No.	30314840
Rotor Capacity	64 x 0.5 ml
Rotor Type	Angle, 40°
Permissible Net Weight	64 x 2.3 g
Lowest Temperatures	2 °C

*No Adapters









Angle Rotor 4 x 8-w PCR Strip	
Item No.	30314841
Rotor Capacity	4 x 8-w PCR Strip
Rotor Type	Angle, 45°
Permissible Net Weight	4 x 3.5 g
Lowest Temperatures	-1 °C











*No Adapters

Rotors for Frontier FC5816 and FC5816R















	Angle Rotor 24 × 1.5/2.0 ml Sealable	
	Item No.	30304361
	Rotor Capacity	24 x 1.5/2.0 ml
	Rotor Type	Angle, 45°
	Permissible Net Weight	24 x 3.4 g
Lowest Temperatures	3°C	











Accessory Specifications	n/a		
Accessory Item No.	n/a	30130884	30130885
Accessory Type	n/a	Adapter	
Max. RPM (FC5718/FC5718R approved)	15,000/16,000		
Max. RCF	21,379/24,325 x g	18,864/21,463 x g	20,624/23,466 x g
Tube Specifications			
Tube Type	Micro Tube		
Tube volume	1.5/2.0 ml	0.2/0.4 ml	0.5 ml
Tubes per Rotor	24		
Max. Tube Diameter (mm)	11	6	8
Tube Height (mm)	40	20	30

	Swing Out Rotor 4 × 250 ml	
	Item No.	30314820
	Rotor Capacity	4 x 250 ml
	Rotor Type	Swing Out, 0-90°
	Permissible Net Weight	4 x 536 g
Lowest Temperatures	-2°C	

Accessory Specifications							
Accessory Item No.	30314901	30314902	30304367	30304368	30314903	30314904	30314905
Accessory Type	Screw Cap	O-Ring	Rack	Adapter	Rack		
Max. RPM (FC5816/FC5816R approved)	4,500/4,500						
Max. RCF	n/a	3,689 x g	3,554 x g	3,599 x g	3,689 x g		
Tube Specifications	n/a						
Tube Type	n/a	Vacutainer	Micro Tube	Flat Bottom	Round Bottom		
Tube volume	n/a	4-10 ml	1.5/2.0 ml	250 ml	100 ml	50 ml	
Tubes per Rotor	n/a	32	36	4			12
Max. Tube Diameter (mm)	n/a	16	11	62	41		
Tube Height (mm)	n/a	75/100	42	110/130			95/120

Accessories			
Items	Screw Cap, Rack of 250ml Rotor, 2/pk	O-ring, Rack of 250ml Rotor, 10/pk	n/a

Accessory Specifications							
Accessory Item No.	30314906	30314907	30314908	30314909	30314910	30314911	30314912
Accessory Type	Rack						
Max. RPM (FC5816/FC5816R approved)	4,500/4,500						
Max. RCF	3,780 x g	3,576 x g		3,644 x g		3,508 x g	3,689 x g
Tube Specifications							
Tube Type	Falcon	Round Bottom	Skirted Conical		Round Bottom	Skirted Conical	Round Bottom
Tube volume	50 ml				25 ml		15 ml
Tubes per Rotor	12	4	8	4	20	12	36
Max. Tube Diameter (mm)	29	34	29		24.5		17
Tube Height (mm)	100/120			116	100/120	85/100	76/115



Accessory Specifications					
Accessory Item No.	30314913	30314914	30314915	30314916	30314917
Accessory Type	Rack				
Max. RPM (FC5816/FC5816R approved)	4,500/4,500				
Max. RCF	3,712 x g	3,644 x g	3,689 x g	3,599 x g	
Tube Specifications					
Tube Type	Falcon	Skirted Conical	Round Bottom		Vacutainer
Tube Volume	15 ml		10 ml	5-7 ml	1.6-7 ml
Tubes per Rotor	28		32	56	40
Max. Tube Diameter (mm)	17		16	13	
Tube Height (mm)	95/120	100/120	80/100	65/120	75/120



Angle Rotor 6 x 250 ml	
Item No.	30314821
Rotor Capacity	6 x 250 ml
Rotor Type	Angle, 28°
Permissible Net Weight	6 x 355 g
Lowest Temperatures	3°C















Accessory Specifications	n/a						
Accessory Item No.	n/a	30304369	30304370	30304371	30304372	30304373	30304374
Accessory Type	n/a	Adapter					
Max. RPM (FC5816/FC5816R approved)	8,000/8,000						
Max. RCF	10,016 x g	9,444 x g	9,515 x g	9,301 x g	8,943 x g	8,585 x g	8,371 x g
Tube Specifications							
Tube Type	Flat Bottom	Micro Tube	Round Bottom	Falcon	Round Bottom		Falcon
Tube volume	250 ml	1.5/2.0 ml	10 ml	15 ml	30 ml	50 ml	
Tubes per Rotor	6	48	30	24	12	6	
Max. Tube Diameter (mm)	62	11	16	17	26	29	30
Tube Height (mm)	-	42	80	120	92	103	118

	Swing Out Rotor 2 x 3 MTP w/bucket	
	Item No.	30314824
	Rotor Capacity	2 x 3 MTP
	Rotor Type	Swing Out, 0-90°
	Permissible Net Weight	2 x 310 g
	Lowest Temperatures	-3°C

Accessory Specifications		
Accessory Item No.	30314890	30314891
Accessory Type	Bucket	Adapter
Max. RPM	4,500	
Max. RCF	2,716 x g	
Tube Specifications	n/a	
Tube Type	Microplate	Microtube
Tube volume	MTP	1.5/2.0 ml
Tubes per Rotor	6 Standard Microplates or 2 Deepwell Plates	96
Max. Tube Diameter (mm)	87 x 128	11
Tube Height (mm)	51	42

Accessories	
Items	Bucket, 3x15ml D17mm FA, w/Rack, 2/pk

	Angle Rotor 6 x 85 ml	
	Item No.	30314826
	Rotor Capacity	6 x 85 ml
	Rotor Type	Angle, 38°
	Permissible Net Weight	6 x 140 g
	Lowest Temperatures	15°C

Accessory Specifications	n/a							
Accessory Item No.	n/a	30314893	30314894	30314895	30314896	30314897	30314898	30314899
Accessory Type	n/a	Adapter						
Max. RPM (FC5816/FC5816R approved)	11,000/13,000							
Max. RCF	15,555/21,762 x g	14,338/20,025 x g	14,067/19,647 x g	14,743/20,592 x g	14,338/20,025 x g	14,067/19,647 x g	15,014/20,970 x g	14,067/19,647 x g
Tube Specifications								
Tube Type	Round Bottom				Falcon	Round Bottom		
Tube volume	85 ml	15 ml	30 ml	50 ml		15 ml		16 ml
Tubes per Rotor	6						12	6
Max. Tube Diameter (mm)	38	17	25	29		17		18
Tube Height (mm)	113	103/110	90/103	105	118	120	95/100	103/110



Angle Rotor 4 x 85 ml	
Item No.	30314827
Rotor Capacity	4 x 85 ml
Rotor Type	Angle, 30°
Permissible Net Weight	4 x 140 g
Lowest Temperatures	5°C

Accessory Specifications	n/a								
Accessory Item No.	n/a	30314893	30314894	30314895	30314896	30314897	30314898	30314899	
Accessory Type	n/a	Adapter							
Max. RPM (FC5816/FC5816R approved)	12,000								
Max. RCF	14,809 x g	13,682 x g	13,521 x g	14,326 x g	13,843 x g	13,360 x g	12,073 x g	13,360 x g	
Tube Specifications									
Tube Type	Round Bottom				Falcon		Round Bottom		
Tube volume	85 ml	15 ml	30 ml	50 ml		15 ml		16 ml	
Tubes per Rotor	4						8		4
Max. Tube Diameter (mm)	38	17	25	29		17		18	
Tube Height (mm)	113	103/110	90/103	105	118	120	95/100	103/110	



Swing Out Rotor 16 x 50 ml	
Item No.	30314828
Rotor Capacity	16 x 50 ml
Rotor Type	Swing Out, 0-90°
Permissible Net Weight	4 x 557 g
Lowest Temperatures	2°C

Accessory Specifications				
Accessory Item No.	30304375	30314583	30314584	30314585
Accessory Type	Rack			
Max. RPM (FC5816/FC5816R approved)	4,500/4,500			
Max. RCF	3,735 x g		3,599 x g	3,531 x g
Tube Specifications				
Tube Type	Falcon		Vacutainer/Sarstedt	
Tube Volume	50 ml	15 ml	5-7 ml	4-10 ml
Tubes per Rotor	16	40	56	48
Max. Tube Diameter (mm)	29	17	13	16
Tube Height (mm)	116	120	75/100	



Angle Rotor 10 x 50 ml	
Item No.	30314829
Rotor Capacity	10 x 50 ml
Rotor Type	Angle, 38°
Permissible Net Weight	10 x 74 g
Lowest Temperatures	9°C

Accessory Specifications	n/a					
Accessory Item No.	n/a	30130886	30130889	30130890	30472300	30472307
Accessory Type	n/a	Adapter				
Max. RPM (FC5816/FC5816R approved)	9,000/10,500					
Max. RCF	11,771/16,022 x g	8,059 x g	11,047 x g	9,417 x g	11,318/15,406 x g	11,590/15,776 x g
Tube Specifications						
Tube Type	Falcon	Micro Tube	Round Bottom		Round bottom	Conical
Tube Volume	50 ml	1.5/2.0 ml	7 ml	5 ml	15 ml	
Tubes per Rotor	10					
Max. Tube Diameter (mm)	29	11	13.5		17	
Tube Height (mm)	118	42	100	65/75	97-123	120

Accessory Specifications				
Accessory Item No.	30130891	30130892	30130893	30314892
Accessory Type	Adapter			
Max. RPM	13,000/13,000			
Max. RCF	15,491 x g	14,924 x g	15,113 x g	14,547 x g
Tube Specifications				
Tube Type	Round Bottom			Falcon
Tube Volume	30 ml	16 ml	15 ml	
Tubes per Rotor				
Max. Tube Diameter (mm)	26	18	17	17.5
Tube Height (mm)	100	100/105		116/125



Angle Rotor 6 x 50 ml	
Item No.	30314831
Rotor Capacity	6 x 50 ml
Rotor Type	Angle, 26°
Permissible Net Weight	6 x 94 g
Lowest Temperatures	-5 °C

Accessory Specifications	n/a				
Accessory Item No.	n/a	30130891	30130892	30130893	30314892
Accessory Type	n/a	Adapter			
Max. RPM (FC5718/FC5718R approved)	12,000/12,000				
Max. RCF	15,869 x g	14,924 x g	12,717 x g	15,113 x g	14,546 x g
Tube Specifications					
Tube Type	Round Bottom				Falcon
Tube Volume	50 ml	30 ml	16 ml	15 ml	
Tubes per Rotor	6				
Max. Tube Diameter (mm)	29	26	18	17	17.5
Tube Height (mm)	95/115	100	100/105		116/125



Angle Rotor 30 x 15 ml	
Item No.	30314832
Rotor Capacity	30 x 15 ml
Rotor Type	Angle, 35°
Permissible Net Weight	30 x 32 g
Lowest Temperatures	-12°C

Accessory Specifications	n/a			
Accessory Item No.	n/a	30130886	30130889	30130890
Accessory Type	n/a	Adapter		
Max. RPM (FC5718/FC5718R approved)	4,500/4,500			
Max. RCF	2,830 x g	2,038 x g	2,762 x g	2,377 x g
Tube Specifications				
Tube Type	Round Bottom/Falcon	Micro Tube	Round Bottom	
Tube Volume	15 ml	1.5/2.0 ml	7 ml	5 ml
Tubes per Rotor	30			
Max. Tube Diameter (mm)	17	11	13.5	
Tube Height (mm)	95/115	42	100	65/75







Angle Rotor 20 x 10 ml	
Item No.	30314833
Rotor Capacity	20 x 10 ml
Rotor Type	Angle, 30°
Permissible Net Weight	20 x 18 g
Lowest Temperatures	0°C

*No Adapters







Angle Rotor 44 x 1.5/2.0 ml	
Item No.	30314835
Rotor Capacity	44 x 1.5/2.0 ml
Rotor Type	Angle, 30°/55°
Permissible Net Weight	44 x 3.8 g
Lowest Temperatures	8°C

Accessory Specifications	n/a		
Accessory Item No.	n/a	30130884	30130885
Accessory Type	n/a	Adapter	
Max. RPM (FC5718/FC5718R approved)	15,000/16,000		
Max. RCF	21,128/24,039 x g	19,367/22,035 x g	20,625/23,467 x g
Tube Specifications			
Tube Type	Micro Tube		
Tube volume	1.5/2.0 ml	0.2/0.4 ml	0.5 ml
Tubes per Rotor	44		
Max. Tube Diameter (mm)	11	6	8
Tube Height (mm)	40	20	30



Angle Rotor 24 x 1.5/2.0 ml	
Item No.	30314838
Rotor Capacity	24 x 1.5/2.0 ml
Rotor Type	Angle, 45°
Permissible Net Weight	24 x 3.4 g
Lowest Temperatures	3°C

Accessory Specifications	n/a		
Accessory Item No.	n/a	30130884	30130885
Accessory Type	n/a	Adapter	
Max. RPM (FC5718/FC5718R approved)	15,000/16,000		
Max. RCF	21,379/24,325 x g	18,864/21,463 x g	20,624/23,466 x g
Tube Specifications			
Tube Type	Micro Tube		
Tube volume	1.5/2.0 ml	0.2/0.4 ml	0.5 ml
Tubes per Rotor	24		
Max. Tube Diameter (mm)	11	6	8
Tube Height (mm)	40	20	30



Wolflabs

Wolf Laboratories Limited

www.wolflabs.co.uk

Tel: 01759 301142

Fax: 01759 301143

sales@wolflabs.co.uk



Use the above details to contact us if this literature doesn't answer all your questions.

Pricing on any accessories shown can be found by keying the part number into the search box on our website.

The specifications listed in this brochure are subject to change by the manufacturer and therefore cannot be guaranteed to be correct. If there are aspects of the specification that must be guaranteed, please provide these to our sales team so that details can be confirmed.

