



User Manual

Elix[®] Essential 3, 5, 10, 15 (UV)

RiOs[™] Essential 5, 8, 16, 24



Congratulations!

Thank you for buying our Water Purification System.
For any questions or requests, please use the contact information provided below.

By Internet

The Internet site can be used to find addresses, telephone/fax numbers and other information.

Internet Site Address:

www.millipore.com

www.millipore.com/techservice

www.millipore.com/lab_water

Manufacturing Site

Millipore SAS
67120 Molsheim
France

Safety information

Your water system should be operated according to the instructions in this manual. In particular, the hydraulic and electrical specifications should be followed and met. It is important to use this equipment as specified in this manual; using this equipment in a different manner may impair the safety precautions of the water system.



This ATTENTION symbol is used to refer to instructions in this manual that need to be done carefully.



These symbols are used to indicate that proper safety equipment has to be used.



Protective glasses and gloves must be worn.



This UV RADIATION sticker is used to refer to a position on the water system Cabinet or inside of it where exposure to UV light is possible.



This DANGER sticker is used to refer to a position on the water system Cabinet or inside of it that could be hazardous.



This ELECTRICAL GROUND sticker is used to refer to a position on the water system Cabinet or inside where an electrical ground connection is made.



This ELECTRICAL DANGER sticker is used to refer to a position on the water system Cabinet or inside where an electrical danger could exist.

IMPORTANT!

Your water system should be installed and operated in a clean and dry area. Please refer to the environment requirements page at the end of this manual.

Your water system is not designed for domestic use.

Powering off the water system for a long period of time can discharge the battery used by the time keeper: time and date can be lost. If the water system is shut off for a long period of time, use the lab closed mode or go through an installation procedure of the water system. Contact your Service Representative.

Save the system's history frequently – every 3 or 6 months.

Documentation usage

The instruction manual found with your water purification system is important for a good usage and the maintenance in compliance with the manufacturer specifications.

Your water system is delivered with two documents, and these are:

- A user manual which describes all specifications, operations and functions of the water system.
- A quick guide that describes quick access to maintenance and operating information.

It may be necessary for to reference these documents for maintenance or other procedures with the water system. It is recommended to store these documents in such way that they can be quickly located and where they will not be damaged.

A plastic folder is provided with the water system. Use this to safety store the documents. You can stick the side of the plastic folder on the side of the water system and place the documents in there if desired.

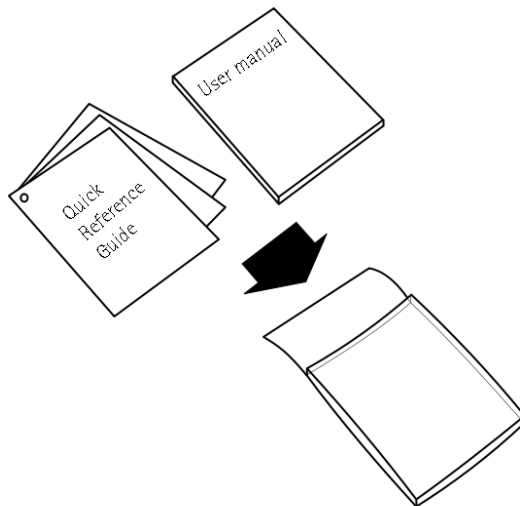

System overview

The water system and its different modules are described here.

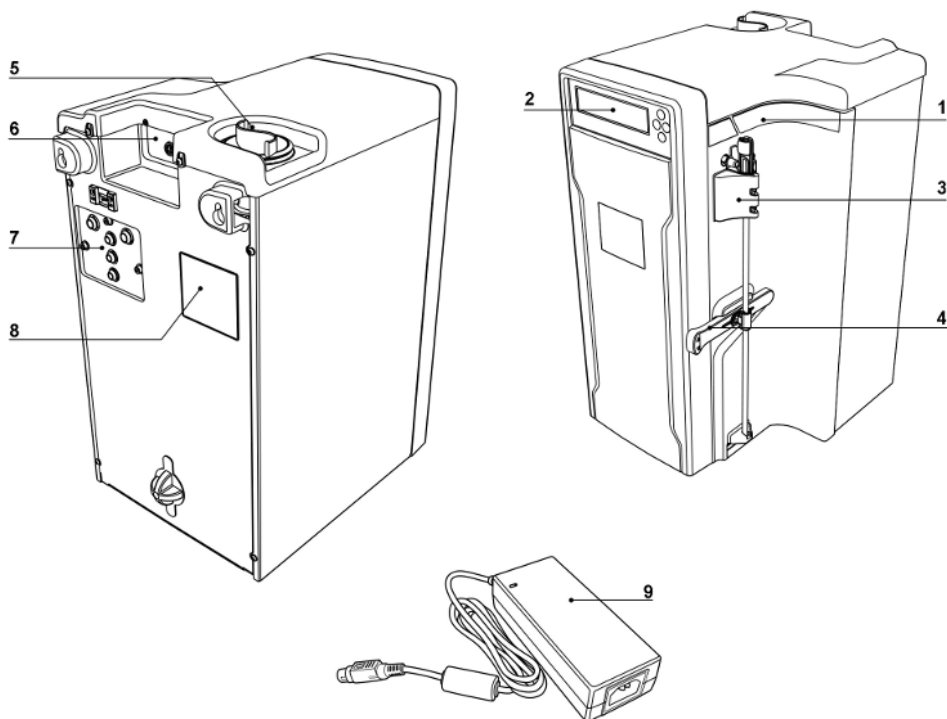

Item	Description	Item	Description
1	System name and type	6	Electrical connections
2	Display and keypad	7	System's hydraulic connections
3	Progard® Pretreatment Pack location	8	System ID and serial number
4	Locking handle	9	External power supply*
5	Sanitization/cleaning port		

* For powering off the system, disconnect the power cord from the power socket. The power cord should be plugged into a wall outlet that is accessible.

Keypad usage

The keypad and its usage are explained below.















Item	Function
1	<p>MODE key</p> <ul style="list-style-type: none"> This button is used to switch between different system modes: Standby mode, Ready mode or in Configuration mode. From Standby, press twice  to go to Ready. From Ready, press once  to go to Standby.
2	<p>LEFT or RIGHT key</p> <p>These buttons are used to navigate in the user interface software. They are also used to change configuration or set point values.</p>
3	<p>VALIDATE key</p> <p>This button is used to confirm a change or an action required by the water system. It is also used to save any changes made in configuration.</p>
4	<p>HELP INDICATOR icon</p> <ul style="list-style-type: none"> There are up to 3 of these icons on the display depending upon the software mode. These indicators are here to tell the user which keypad button is available and active. <p>See the examples below:</p> <div style="display: flex; align-items: flex-start;"> <div style="margin-right: 20px;"> <p>3 help indicators:</p> <ul style="list-style-type: none"> Press on  (Mode key) to switch operating mode. Press on  to navigate in the software branch. Press on  (Validate key) to configure ECO mode. <p>2 help indicators:</p> <ul style="list-style-type: none"> Press on  (Mode key) to switch operating mode. Press on  to navigate in the software branch. <p>1 help indicator:</p> <ul style="list-style-type: none"> Press on  (Mode key) to switch operating mode. </div> <div>  </div> </div>

Table of contents



Table of contents

Items needed.....	11
Items checklist.....	12
Millitrack® Software - option.....	13
System	15
Display icons.....	16
Software modes.....	17
Operating principle and status.....	18
Maintenance information 	19
Configure system parameters 	20
View operation parameters.....	22
Software navigation map	23
Consumables replacement	25
Replacing Progard® Pack	26
Sanitization and cleaning	29
Sanitizing RO membranes with chlorine 	30
Cleaning RO membranes with acid/base (pH)	31
Other functions	33
Saving display energy - ECO mode	34
System is not used for a long time - Lab Closed	35
Error messages.....	37
Error codes	38
Basic troubleshooting.....	39
Chemical and technical specifications.....	41
Specifications and requirements	42
Legal information.....	45
Notice	46
Copyright.....	46
Trademarks.....	46
Product warranty and limitation of liability	47
Recycling	47

Item catalog numbers.....	49
Consumables catalog numbers	50
Optional consumables catalog numbers	50
Optional equipment catalog numbers.....	51
System's catalog numbers.....	51

Items needed



Items needed

Items checklist

Verify that all items are available before beginning the installation.
See the "Content list" for more details.

- Water system unit (A)
- User manual and Quick Reference Guide (B)
- External power supply (C)
- Progard® Pack (D)
- Accessories bag with:
 - Tubings
 - Fittings
 - Power cord
 - Elbow tubing guides

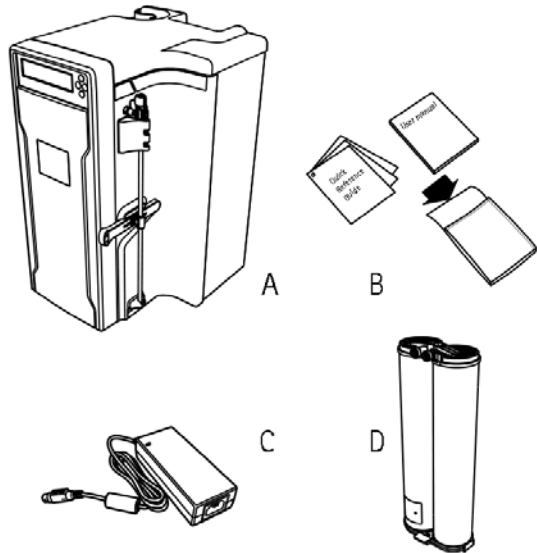

Millitrack® Software – option

Millitrack® Software is an embedded GUI (graphical user interface) developed with AJAX (Asynchronous JavaScript and XML) techniques that generate interactive web pages through a point-to-point computer or direct network connection using TCP/IP Ethernet protocol.

Millitrack® Software allows a lab user to download or view instantaneously quality data through their internet browser for rapid monitoring of his water purification system.

Millitrack® Software users have also real-time remote access to interactive web pages through standard TCP/IP network describing water purification system status, configuration, instant quality parameters, settings, identification and Dashboard.

Key Benefits:

- Native Web graphical user interface.
- Real-time and remote Dashboard of water systems.
- XML data format available for print or download to any spreadsheet database.
- Compatible with any lab data management system such as LIMS, ELN, SDMS/ECM.

The screenshot displays the Millitrack® Software web interface. At the top left is a "Logout" link. At the top right is the "iM" logo. Below the logo is a navigation menu: "INSTANT QUALITY - ADVANCED PARAMETERS - HISTORY - CONFIGURATION - CALIBRATION - MAINTENANCE - DASHBOARD - CONTACTS".

The main content area is divided into three sections:

- SYSTEM INFORMATION**: A table with the following data:

System Type	Elix 10
Catalogue Number	CAT001
Serial Number	F2BA12345
System Version	1.14
Date	25/09/2011
Time	18:22:34
- ACME MEASURES**: A table with the following data:

Elix Resistivity	10.0	MQ.cm
Elix Temperature	25.0	°C
- USER INFORMATION**: A table with the following data:

Manager	
Company	
Department	

At the bottom right of the interface are two buttons: "SAVE A COPY" and "PRINTER FRIENDLY".

System



Display icons

Know how to interpret each icon displayed. Display with all symbols is represented below.

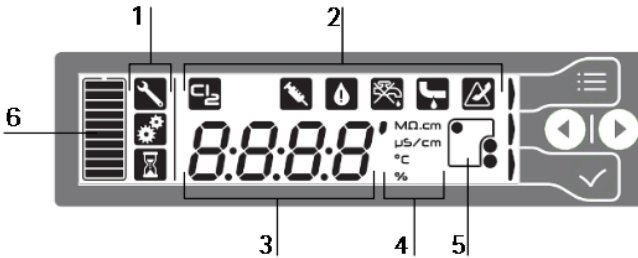











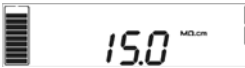





Item	Description
1	System's status icons are <ul style="list-style-type: none"> Maintenance or tool: the system is in Standby or maintenance can be started. Configuration or gears: configuration parameters such as set points can be changed. Process or hour glass: the system is busy. No action can be done.
2	Warning maintenance or alarm (from left to right) are displayed to indicate that: <ul style="list-style-type: none"> CL2 sanitization is required: perform the sanitization of the RO cartridge. System sanitization is required. Product water resistivity is below set point. Low feed water pressure is detected. Water is detected (if water sensor installed). Contact Millipore.

Item	Description
3	Values area is used to display <ul style="list-style-type: none"> Water quality measures. Software menu and configuration values. Error code numbers.
4	Units are <ul style="list-style-type: none"> ' or minutes. MΩ.cm or megOhm centimeter. µS/cm or micro siemens by centimetre. °C or temperature degree Celsius. % or percentage.
5	Consumables status icons are used to indicate that a maintenance action is required. <ul style="list-style-type: none"> For more information, refer to the Quick Guide or the Consumables Replacement section in this document.
6	<ul style="list-style-type: none"> Tank water level is represented by 10 bars. Each bar represents 10% of the total volume of water in the tank. The outline is blinking when the tank is empty.

Software modes

The different software modes are described below with some examples.

	<ul style="list-style-type: none"> • System is in Standby or maintenance. • Tank is 70%. • Tool icon indicates maintenance.
	<ul style="list-style-type: none"> • System is in Standby or maintenance. • Tool icon indicates maintenance. • Values area indicates CL2 sanitization start.
	<ul style="list-style-type: none"> • Gears icon indicates parameters. • Values area indicates ECO mode setting.
	<ul style="list-style-type: none"> • System is in Ready or in Tank filling or in Tank full. • Tank is 90%. • Product water resistivity is 15 MΩ.cm.
	<ul style="list-style-type: none"> • Tank is 70%. • Product water resistivity is 15 MΩ.cm. • The Progard® pack must be changed in 15 days: order a new Progard® pack.
	<ul style="list-style-type: none"> • Yellow color display and : the Progard® pack must be changed. • Product water resistivity is 15 MΩ.cm.
	<ul style="list-style-type: none"> • Yellow color display and : the CL2 cleaning must be started. • Product water resistivity is 15 MΩ.cm.
	<ul style="list-style-type: none"> • Yellow color display, Er:20 and . • The system has detected a minor problem that does not affect the normal operation. Refer to section Error codes at page 38.
	<ul style="list-style-type: none"> • Red color display and . • The system has detected a dysfunction when operating in normal conditions. In this example, system has detected a low feed water pressure and has stopped. More investigation is required.
	<ul style="list-style-type: none"> • Red color display, Er:02 and . • The system has detected a dysfunction when operating in normal conditions. Refer to section Error codes at page 38.
	<ul style="list-style-type: none"> • Red color display and : the Progard® pack has been removed. • Tool icon indicates maintenance.

Operating principle and status

The RiOs™ Essential is a water system designed to produce type III water. The Elix® Essential is a water system designed to produce type II water. This water can be stored in a reservoir, if installed.

As a summary, the Elix® Essential purifies tap water using the Progard® Pack and Reverse Osmosis followed by Electrical Deionization ("EDI"). There is no EDI in a RiOs™ Essential system.

Understanding the terminology of operating status.

TANK FILLING The tank is being filled with EDI or RO water. A sensor starts and stops this mode.

FLUSH A periodic flush of the RO portion of the system is done. This refreshes the water in this part of the system if they are not being used to produce water.

RINSING A sensor has determined that the RO portion needs to rinse itself before sending water to the EDI device.

SANITIZATION There are different types of sanitization that can be done. See the maintenance section in this document for more information.

CLEANING An acid or base cleaning can be done. A packaged chemical is available for this type of cleaning. See the Ordering information section at the end of this document.

Maintenance information

Some information can be shown on the display.



CL2

In this view, the chlorine sanitization can be performed.



PH

In this view, the acid or base cleaning can be performed.

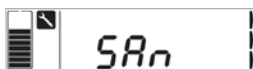

SAN

In this view, the system's sanitization can be performed by a qualified service representative.



LF 02

In this view, the UV Lamp 254 nm lifetime can be reset once it has been changed by a qualified service representative.

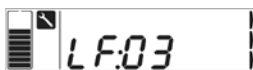

LF 03

In this view, the UV Lamp ASM lifetime –if installed and activated, can be reset once it has been changed by a qualified service representative.





LAB C

In this menu, the Lab Closed mode can be activated.

Configure system parameters

Access and configure all system parameters.

 SP 01
Set point for the tank level where the water system goes in Tank Filling.

 SP 02
Set point for the RO % Rejection. Below this set point, an alarm is indicated. This measurement indicates the percent of ions removed by the RO relative to the amount of ions entering it.

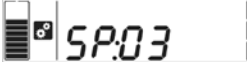
 SP 03
Set point for the resistivity or conductivity for product water. Below this set point, an alarm is indicated.

 DATE
Menu where date and time can be adjusted.

 IP AD – used with Millitrack® software
Menu where the actual IP address can be viewed.

 IP DF - used with Millitrack® software
Menu where the actual IP address can be reset and switched to the default one.

 ECO
Menu where the display energy saving mode can be activated or deactivated.

 ASM
Menu where Automatic Sanitization Module can be activated.

 C ---
Restricted menu accessible with a code and used for Service.

An example of a configuration change: the DATE (YYYY, MM, DD) and TIME (00:00).



1-System is in STANDBY mode. Press on right arrow .



2-In maintenance menu, press .

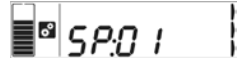

3-Press on right arrow until the date menu is displayed.



4-Press to enter dAtE menu.



5-Change year with arrows and press .



6-Change month with arrows and press .



7-Change day with arrows and press .



8-The date is set now.



9-Set the time. Press .

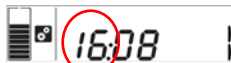



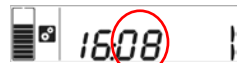















10- Change with arrows and press .



11- Change with arrows and press .

View operation parameters

In Ready or Tank filling, press and hold 2 sec on left or right arrow  to access operation parameters.

 d1	Tap water feed conductivity value can be displayed by pressing  .	 620 <small>µS/cm</small>
 d2	RO feed water conductivity value can be displayed by pressing  .	 685 <small>µS/cm</small>
 d3	RO water temperature value can be displayed by pressing  .	 16.8 <small>°C</small>
 d4	RO pump pressure value can be displayed by pressing  .	 4.5
 d5	RO % rejection value can be displayed by pressing  .	 98.6 <small>%</small>
 d6	On Elix® Essential: RO permeate water conductivity value can be displayed by pressing  .	 12.5 <small>µS/cm</small>

Note:

the product water quality and temperature are displayed on the main display view.

On RiOs™ Essential, the RO permeate water conductivity is shown on the main display:



Press arrow to view temperature.

On Elix® Essential, the resistivity or conductivity is shown on the main display:



Press arrow to view temperature.

Software navigation map

The software map below shows the main menus available in the system.

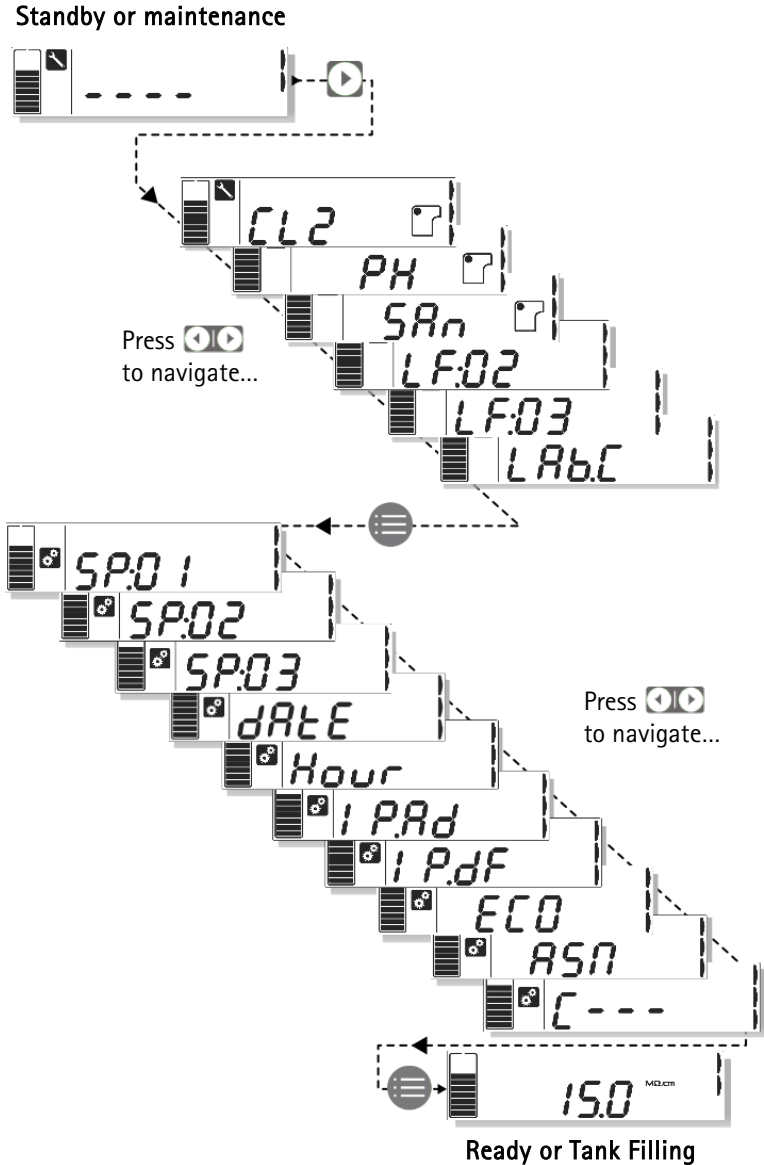

Consumables replacement



Replacing Progard® Pack

When the system shows the icon , order a new Progard® Pack.

When the system displays the yellow alert , replace the pack.

Note:

it is recommended to replace the Vent Filter at this time. Additionally, it is recommended to clean the feed water strainer.

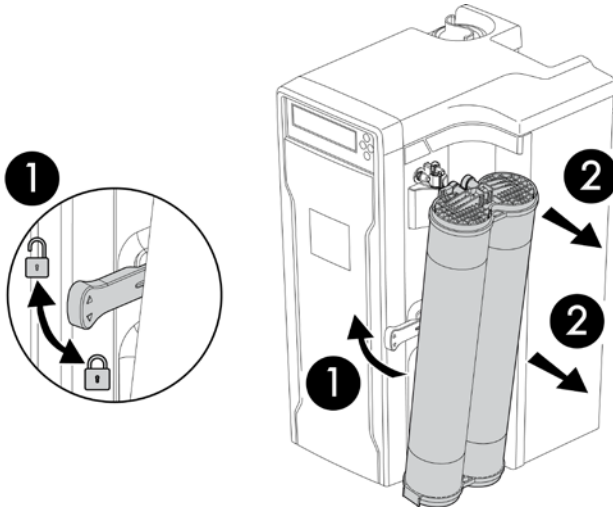

Removing exhausted pack

Verify or put the system in Standby by pressing  - MODE key.

- 1 Unlock the locking handle by pulling up.
 - 2 Pull out the pack.
-

Note:

when the Progard® Pack is removed, a red color display appears. This is normal. This will go away when a new pack is installed.

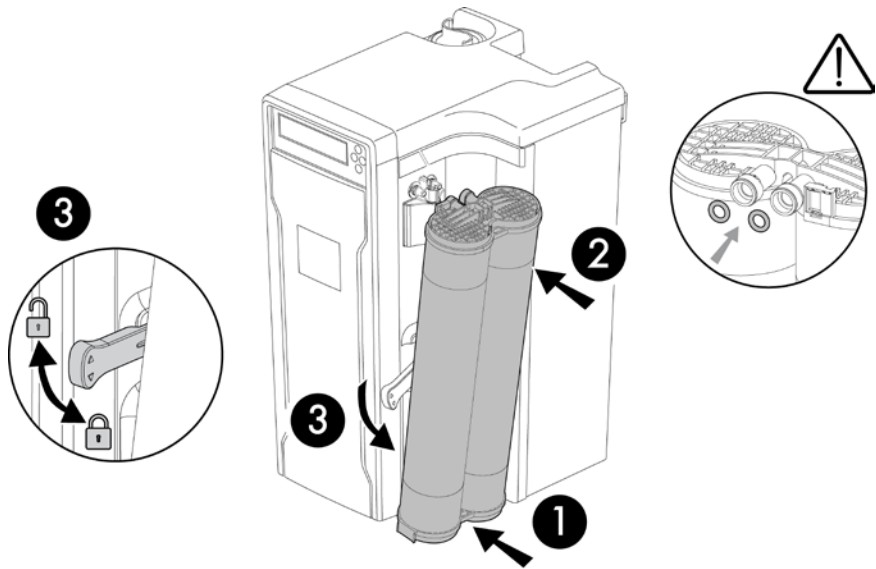

Placing new pack

Remove the new pack from its shipping box. Remove the 2 protective caps from the ports at the top of the pack.





Locate the o-ring inside each port. Make sure the o-rings are push inside against the inner edge of the ports.

- 1 Mount the bottom of the Pack onto the small hole in the cabinet. Swing the rest of the Pack so that the top of the Pack aligns with pack locking handle and the cabinet ports.
- 2 Push the top of the Pack in-place.
- 3 Push the Pack locking handle down to secure the Pack.
 - *The new pack is detected.*
 - *The display prompts you to start a Progard® flush: press  for 1 second.*
 - *Wait 15 minutes for the Progard® flush to finish.*

Sanitization and cleaning



Sanitizing RO membranes with chlorine

- A chlorine tablet is periodically used to reduce or remove a layer of bio film on the feed water side of the RO membrane.
- When the system shows the yellow alert , put the system in Standby by pressing .

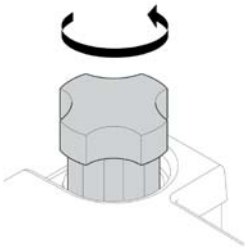

1-Using the tool, unscrew the sanitation port cap.

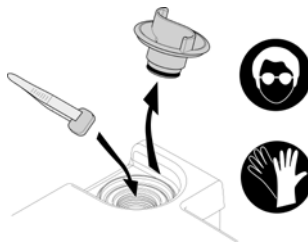

2-Remove the plug and insert the tablet in the port.



3-Screw the plug back: make sure the o-ring is in place.

 **Use proper safety equipment.**

Starting CL2 sanitization



1-Press  for 1 second to start CL2 sanitization.

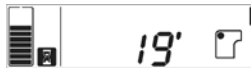

2- The sanitization lasts 19 min.



3-System goes in Ready or in Tank filling.

Cleaning RO membranes with acid/base (pH)

- It may become necessary to remove any built up layer of mineral scale or organic material. This is done with a pH Cleaner. Contact your service representative for more information about their use.
- To start the cleaning, make sure the system is in Standby or put the system in Standby by pressing .



1-Using the tool, unscrew the sanitation port cap.

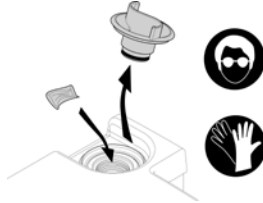

2-Remove the plug and insert the tablet in the port.



3-Screw the plug back: make sure the o-ring is in place.

Note:

do not use the tool to screw the plug – the plug may be screwed too tightly.

Starting pH cleaning



1-In Standby, press .



2-Press on right arrow  to reach PH.



3-Press  for 1 second to start pH cleaning.

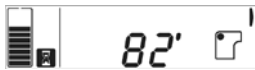

4-The cleaning lasts 82 minutes.



5-Once the cleaning is finished, press  to put the system in Standby.

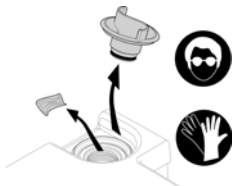

6-Unscrew the plug and remove the empty pouch from the cleaning port.



7-Screw the plug back and put the system in Tank filling by pressing twice .

Other functions



Saving display energy - ECO mode

When this function is activated, the ECO mode is used to save energy when the display is not used. It shuts down the system's display backlight after a 15 min period of non-use.

The ECO mode is disabled by pressing a keypad button or when a warning message is displayed by the system (error code or warning symbol).

Configuring ECO mode



1-Put the system in Standby by pressing .



2-Press  once again.

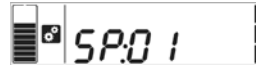

3-You are in configuration mode.



4-Press on right arrow  until you reach

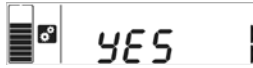

5-Press  to change the setting between YES or...



6-NO. Press  to confirm and exit.

System is not used for a long time – Lab Closed

You can use the Lab Closed function whenever the system is not be used for a long time. In this mode, water quality is maintained by periodic automatic flushing and rinsing



Do not power off the system! The system time and date can be lost as a result. If the system is shut off for a long period of time, contact your service representative.

If required, empty the tank using the front valve.

- 1-Insert one end of the tubing in the ball valve. And the other end to drain.
- 2-Open the ball valve.

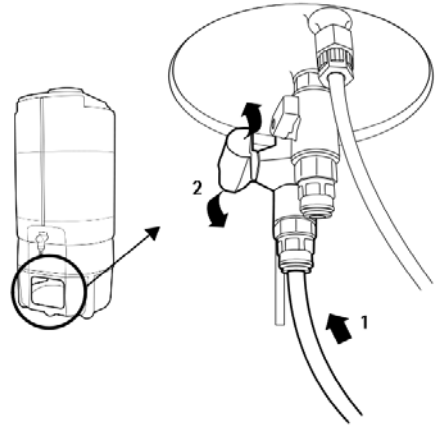

Configuring Lab Closed mode



- 1-Put the system in Standby.



- 2-Press on right arrow  until you reach:



- 3-Press  to activate the Lab Closed mode.

Exiting Lab Closed Mode

- 1- Close the ball valve



- 2-From lab closed mode: press  for 1 second.

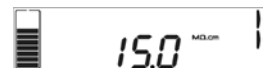

- 3-The system goes in Tank filling.

Error messages



Error codes

An error code is always displayed with  and can be displayed in two different ways:

Yellow alert error:





Red alarm error:



The list of error codes is presented below.

Code	Meaning	What to do?
Er:01	Tap feed water conductivity > set point	Contact your service representative.
Er:02	Feed water temperature > set point	See next page.
Er:03	RO permeate conductivity > set point	Contact your service representative.
Er:04	RO % rejection < set point	Contact your service representative.
Er:05	RO Feed water conductivity < min	Contact your service representative.
Er:06	RO Feed water conductivity > max	Contact your service representative.
Er:07	RO permeate temperature < min	Contact your service representative.
Er:08	RO permeate temperature > max	Contact your service representative.
Er:09	RO permeate conductivity < min	Contact your service representative.
Er:10	RO permeate conductivity > max	Contact your service representative.
Er:11	EDI product temperature < min (Elix®)	Contact your service representative.
Er:12	EDI product temperature > max (Elix®)	Contact your service representative.
Er:13	EDI product resistivity < min (Elix®)	Contact your service representative.
Er:14	EDI product resistivity > max (Elix®)	Contact your service representative.
Er:20	Network cable is unplugged	See next page.
Er:21	No response from DHCP server	Contact your network administrator.
Er:22	Incorrect IP address	Contact your network administrator.
Er:24	Replace UV lamp 254 nm (Elix®)	See next page.
Er:25	Check UV lamp 254 nm (Elix®)	Contact your service representative.
Er:26	Replace UV lamp ASM	See next page.
Er:27	Check UV lamp ASM	Contact your service representative.
Er:30	No response from cold fire microprocessor	Contact your service representative.

Basic troubleshooting

Icon or error	What to do?
	<ul style="list-style-type: none"> • Product water resistivity < set point or RO permeate water conductivity > set point. • Verify the consumables have been replaced.
	<ul style="list-style-type: none"> • Low feed water pressure is detected (0.5 bar). • Verify the feed water faucet is opened. • Verify the feed water pressure is in specification. • Verify the feed water pressure regulator is well adjusted or is working properly (if installed).
	<ul style="list-style-type: none"> • Water leak is detected.
Er:02	<ul style="list-style-type: none"> • Feed water temperature > 35°C. • Verify that the feed water temperature is really greater than 35 °C. See the feed water quality requirements to operate the system in compliance with the manufacturer specifications.
Er:20	<ul style="list-style-type: none"> • Network cable is unplugged: cancel the warning or plug the Ethernet cable.
Er:24	<ul style="list-style-type: none"> • Replace UV lamp 254 nm: the UV lamp is exhausted. • Contact your Service Representative for replacing the UV Lamp 254 nm.
Er:26	<ul style="list-style-type: none"> • Replace UV lamp ASM: the UV lamp is exhausted. • Contact your Service Representative for replacing the UV Lamp ASM.

Chemical and technical specifications



Specifications and requirements

Product water specifications

Ion rejection (RiOs™ Essential)	> 95%
Particle rejection (RiOs™ Essential)	> 99%
Resistivity (Elix® - Elix® UV)	> 5 MΩ.cm @ 25 °C
Conductivity (Elix® - Elix® UV)	< 0.2 μS/cm @ 25 °C
Total Organic Carbon (TOC) (Elix® - Elix® UV)	< 30 ppb
Micro organisms for Elix®	< 100 cfu/mL
Micro organisms for Elix® UV	< 10 cfu/mL
Dissolved silica	< 5 ppb
System and reservoir max length tubing	6 m

Product water flow rates

Elix® Essential 3 (UV) system	3 L/h
Elix® Essential 5 (UV) system	5 L/h
Elix® Essential 10 (UV) system	10 L/h
Elix® Essential 15 (UV) system	15 L/h
RiOs™ Essential 5 system	5 L/h
RiOs™ Essential 8 system	8 L/h
RiOs™ Essential 16 system	16 L/h
RiOs™ Essential 24 system	24 L/h

Feed water quality requirements

Pressure	1 – 6 bar
Flow rate	> 5 L/min at 2 bar
Type	Potable
Temperature	5 – 35 °C
Conductivity	100 – 2000 μS/cm at 25 °C
pH	4- 10
Langelier Saturation Index (LSI)	< 0.3
Free total chlorine	< 3 ppm

Water system weight

Dry weight (Elix® - Elix® UV)	13.8 – 15.5 kg
Operating weight (Elix® - Elix® UV)	17.2 – 18.7 kg
Dry weight (RiOs™)	12.4 – 13.6 kg
Operating weight (RiOs™)	14.4 – 15.7 kg

Water system dimensions

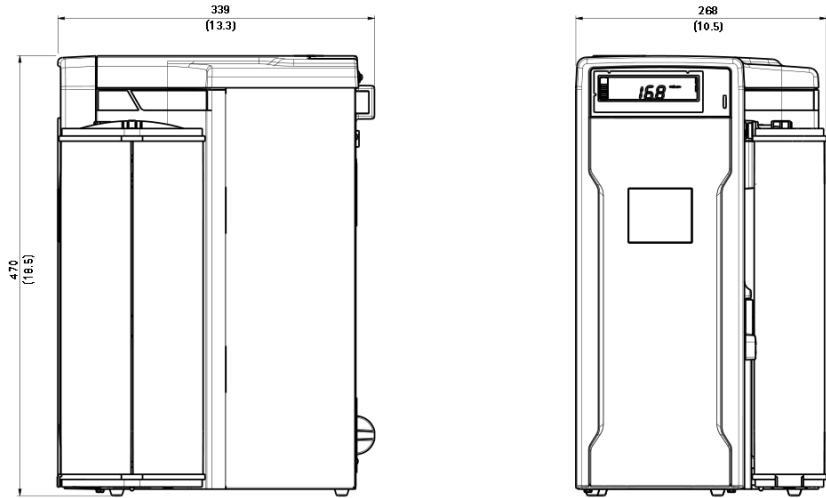

Electrical specifications

Voltage	100-240 VAC $\pm 10\%$
Frequency	50-60 Hz $\pm 10\%$
Power consumption	150 W
Elix® / RiOs™ input	24 VDC, 6.25 A

Environmental requirements

Altitude	< 2000 m
Ambient operating temperature	5 – 40 °C
Ambient storage temperature	5 – 40 °C
Installation category	I
Pollution degree	2
Relative humidity during storage and operation	Maximum relative humidity 80% for temperatures up to 31°C decreasing linearly to 50% relative humidity at 40°C.
Noise level	< 50 db at 1 meter
Indoor use only	



Notice

The information in this document is subject to change without notice and should not be construed as a commitment by Millipore SAS. Millipore SAS assumes no responsibility for any errors that might appear in this document. This manual is believed to be complete and accurate at the time of publication. In no event shall Millipore SAS be liable for incidental or consequential damages in connection with or arising from the use of this manual.

We manufacture and sell water purification systems designed to produce pure or ultra pure water with specific characteristics ($\mu\text{S}/\text{cm}$, T, TOC, CFU/ml, Eu/ml) when it leaves the water purification system provided that it's fed with water quality within specifications, and properly maintained as required by the supplier.

We do not warrant these systems for any specific applications. It is up to the end user to determine if the quality of the water produced by our systems matches his expectations, fits with norms/legal requirements and to bear responsibility resulting from the usage of the water.

Copyright

© 2012 Millipore SAS. Printed in France. All rights reserved. This book or parts thereof may not be reproduced in any form without the written permission of the publishers.

The photos are non-contractual.

Trademarks

Elix, Progard and Millitrack are registered trademarks of Merck KGaA.

RiOs is a trademark of Merck KGaA.

The "M" Mark is a trademark of Merck KGaA.

All other trademarks are trademarks of their respective manufacturers.

Product warranty and limitation of liability

The applicable warranty and limitation of liability for the products listed in this publication may be found at <http://www.millipore.com/ec/cp3/terms> within the "Terms and Conditions of Sale" applicable to your purchase transaction.

Recycling



Directive 2002/96 EC: For European users only

The symbol "crossed bin" on a product or its packaging indicates that the product should not be treated like household waste when discarded. Instead the product should be disposed of at a location that handles discarded electric or electronic equipment.

Proper disposal of equipment containing electric or electronic components will help to reduce pollution effects to the environment or to human health. Proper recycling of these products helps in environmental preservation and helps to protect natural resources. For more information about recycling of products containing electric or electronic components, please contact your local recycling representative or organization.

Item catalog numbers



Consumables catalog numbers

Name	Description	Reference
PROGARD® T2	Pre-treatment pack	PROG0T0S2
PROGARD® T2 WITHOUT SILVER	Pre-treatment pack	PROG0T0S2US
PROGARD® T2 WITHOUT POLYPHOSPHATE	Pre-treatment pack	PROG0TNP2
PROGARD® T2 WITHOUT POLYPHOSPHATE WITHOUT SILVER	Pre-treatment pack	PROG0TNP2US

SANITIZATION TABLETS	Chlorine tablets (50 per pack)	ZWCL01F50
SANITIZATION TABLETS – US only	Chlorine tablets (24 per pack)	5874316024
SANITIZATION TABLETS – Canada only	Chlorine tablets (24 per pack)	5874316024C
RO ACID CLEANER	Acid pouch (12 per pack)	ZWACID012
RO BASE CLEANER	Base pouch (12 per pack)	ZWBASE012

PE RESERVOIR VENT FILTER SODA LIME	For type 2 water	TANKMPK01
PE RESERVOIR VENT FILTER	For type 3 water	TANKMPK02
PE RESERVOIR VENT FILTER 0.22 µm	Membrane filter	TANKMPK22

UV LAMP 254 NM		ZLXUVLP01
----------------	--	-----------

Optional consumables catalog numbers

Name	Description	Reference
PACK SUPPORT	Ext. pre-treatment bracket	ZFPAKSP2
PREPAK	Ext. pre-treatment pack	PRPK00001
PREPAK WITHOUT SILVER	Ext. pre-treatment pack	PRPK00001US

Optional equipment catalog numbers

Name	Description	Reference
PE RESERVOIR 30	Round polyethylene reservoir	TANKPE030
30 L PE UNDERBENCH TANK	Round under bench reservoir	TANKBI030
PE RESERVOIR 60	Round polyethylene reservoir	TANKPE060
PE RESERVOIR 100	Round polyethylene reservoir	TANKPE100
100 L PE UNDERBENCH TANK	Square under bench reservoir	ZBITANK01
SDS 200	200 L SDS tank alone	TANK00200
TANK CONNECTION KIT	Connection kit Elix® to SDS	SDSELECKT
TANK LEVEL SPLITTER	Tank level display splitter	ZSTWINLX2
— ■ —		
ASM 2011	Automatic sanitization module	TANKASMES
WATER SENSOR	Water leak detector	ZFWATDET4
— ■ —		
WALL MTG BRACKET	System wall mounting bracket	SYSTFIX01
EXTERNAL RELAY KIT	Alert/alarm relay	KITRELESS
SANITIZATION KIT	System's sanitization	SANKIT003

System's catalog numbers

Name	Description	Reference
Elix® Essential 3		ZLXE0030WW
Elix® Essential 5		ZLXE0050WW
Elix® Essential 10		ZLXE0100WW
Elix® Essential 15		ZLXE0150WW
Elix® Essential 3 UV	With UV lamp 254 nm	ZLXEUV030WW
Elix® Essential 5 UV	With UV lamp 254 nm	ZLXEUV050WW
Elix® Essential 10 UV	With UV lamp 254 nm	ZLXEUV100WW
Elix® Essential 15 UV	With UV lamp 254 nm	ZLXEUV150WW
RiOs™ Essential 5		ZROE0050WW
RiOs™ Essential 8		ZROE0080WW
RiOs™ Essential 16		ZROE0160WW
RiOs™ Essential 24		ZROE0240WW



FTPF12381



V2.0