

Operating instructions

Refrigerator

Read the operating instructions before switching on for the first time

Page 14

GB

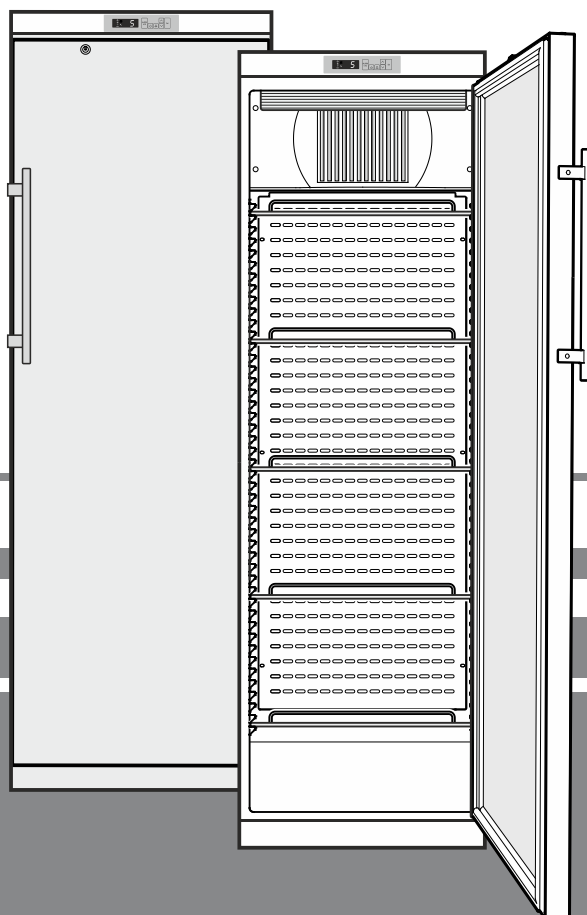

7084 677-00

MKv

LIEBHERR

Content

Features	16
Climate rating	16
Energy consumption	16
Temperature increase after a power failure	16
Range of appliance use	16
Setting up	16
Appliance dimensions	16
Electrical connection	17
Operating and control elements	17
Interior temperature	17
Switching the appliance on and off	18
Audible warning signal	18
Power failure alarm	18
Door open alarm	18
Setting the delay time for the door open alarm	18
Audible warning signal settings	19
Alarm messages	19
Alarm test	19
Calling up stored alarm events and reading the temperature progression	20
Resetting the recorded temperature progression <i>r-t</i>	20
Example of an alarm query	20
Changing the network address	21
Resetting the parameters to factory settings	21
Setting the real time clock	21
Interior light MKv 3913	22
Safety lock	22
Defrosting	22
Setting the display indication for the defrost phase	22
Cleaning and disinfection	23
Malfunctions	23
Shutting your appliance down	23
External alarm	24
Changing over door hinges	25

Disposal notes

The appliance contains reusable materials and should be disposed of properly - not simply with unsorted household refuse. Appliances which are no longer needed must be disposed of in a professional and appropriate way, in accordance with the current local regulations and laws.



When disposing of the appliance, ensure that the refrigerant circuit is not damaged to prevent uncontrolled escape of the refrigerant it contains (data on type plate) and oil.

- Disable the appliance.
- Pull out the mains plug.
- Cut through the connection cable.

WARNING

Danger of suffocation due to packing material and plastic film!

Do not allow children to play with packaging material.

Take the packaging material to an official collection point.

A rechargeable battery is installed in the appliance.

Disposal instructions for batteries

The battery must be removed when you wish to dispose of the appliance and sent for separate waste treatment for batteries.

Do not damage or short circuit the battery.

Description of the appliance

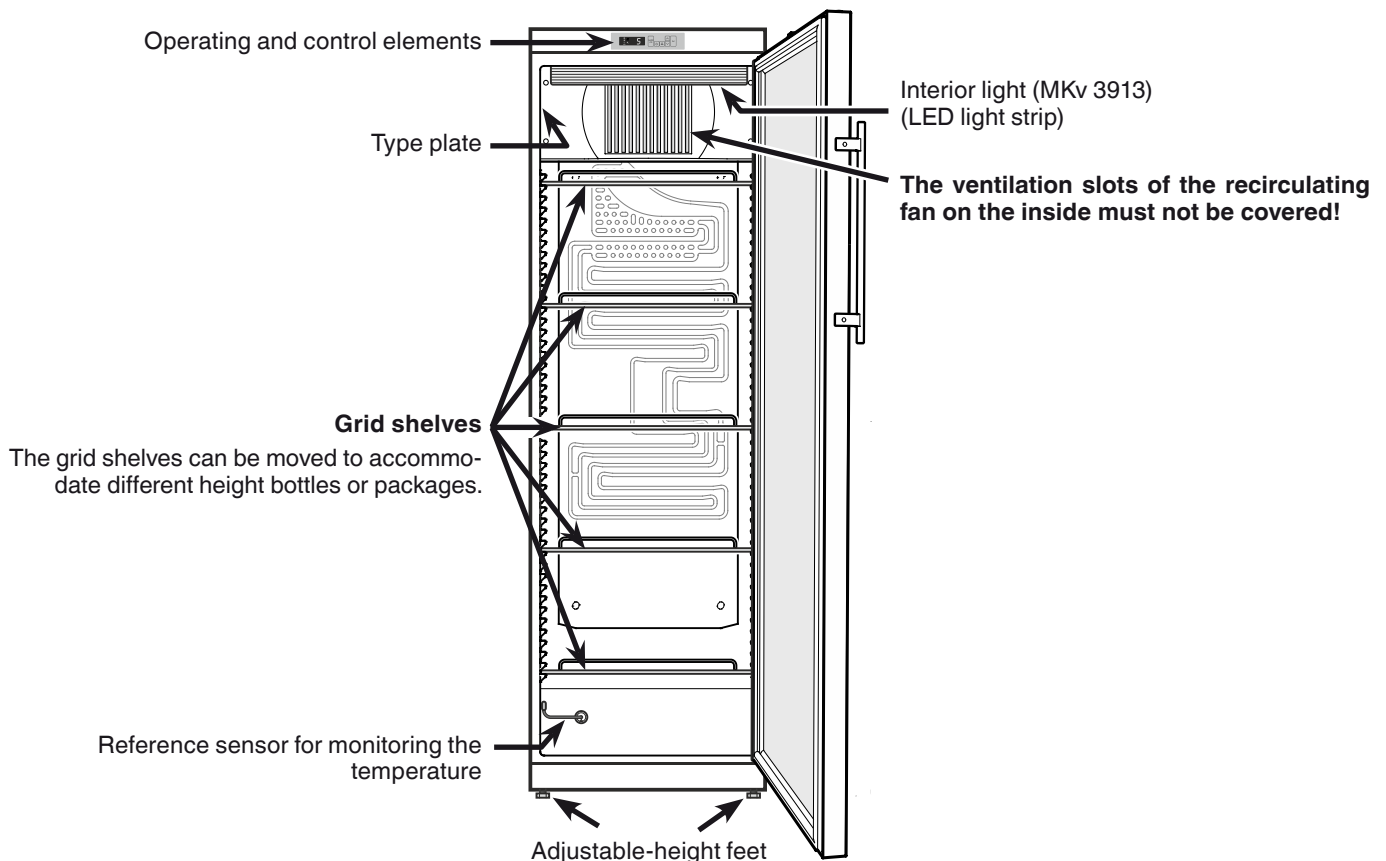

Safety instructions and warnings

- To prevent injury or damage to the unit, the appliance should be unpacked and set up by two people.
- In the event that the appliance is damaged on delivery, contact the supplier immediately before connecting to the mains.
- To guarantee safe operation, ensure that the appliance is set up and connected as described in these operating instructions.
- Disconnect the appliance from the mains if any fault occurs. Pull out the plug, switch off or remove the fuse.
- When disconnecting the appliance, pull on the plug, not on the cable.
- Any repairs and work on the appliance should only be carried out by the customer service department, as unauthorised work could prove highly dangerous for the user. The same applies to changing the mains power cable.
- Do not allow naked flames or ignition sources to enter the appliance. When transporting and cleaning the appliance, ensure that the refrigerant circuit is not damaged. In the event of damage, make sure that there are no ignition sources nearby and keep the room well ventilated.
- Do not stand on the plinth, drawers or doors or use them to support anything else.
- This appliance can be used by children of 8 years old and over, and also by persons with restricted physical, sensory or mental capacity or lack of experience and knowledge, if they are supervised or have been instructed on safe use of the appliance and understand the resulting risks. Children must not be allowed to play with the appliance. Cleaning and user maintenance must not be carried out by children without supervision.
- Avoid prolonged skin contact with cold surfaces or chilled/frozen food. This could cause pain, numbness and frostbite. In the case of prolonged skin contact, protective measures should be taken, e.g. gloves should be worn.
- Do not store explosives or sprays using combustible propellants such as butane, propane, pentane, etc. in the appliance. Electrical components might cause leaking gas to ignite. You may identify such sprays by the printed contents or a flame symbol.
- Do not use electrical appliances inside the appliance.
- If you have a lockable appliance, do not keep the key near the appliance or within reach of children.
- The appliance is designed for use in enclosed areas. Do not operate the appliance outdoors or in areas where it is exposed to splash water or damp conditions.
- The LED light strip illuminates the interior of the appliance. It is not suitable for lighting a room.
- Do not install the appliance in the immediate vicinity of an air-conditioning unit. The appliance should also not be operated under a wall-mounted air-conditioning unit.
- The appliance is **not** suitable for storing blood bottles pursuant to DIN 58371.
- In special fields of application which are subject to their own standard, the user is responsible for complying with this standard.

Features

- Audible and visual temperature alarm.
- Audible and visual door open alarm.
- Floating contact for connection to a remote monitoring system.
- Serial interface (RS485) for external temperature and alarm documentation.
- Maximum/minimum interior temperatures are stored.
- Last 3 temperature alarms are saved with time, date and duration of alarm.
- Last 3 power cuts are saved with time, date and duration of power cut.
- Safety thermostat to avoid temperatures below +2°C.

It is essential to use these safety facilities to avoid damage to stored items. These facilities must not be deactivated or decommissioned!

Climate rating

The climate rating indicates the room temperature at which the appliance may be operated in order to achieve full refrigeration performance.

The climate rating is indicated on the type plate. The position of the type plate is shown in the section entitled **Description of the appliance**.

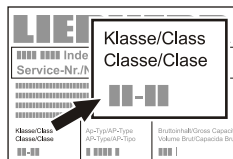

Climate rating	Room temperature
SN	+10°C to +32°C
N	+16°C to +32°C
ST	+16°C to +38°C
T	+16°C to +43°C
SN-ST	+10°C to +38°C
SN-T	+10°C to +43°C

Do not operate the appliance outside the specified room temperature range.

Energy consumption

Temperature increase after a power failure

Model	MKv 3910	MKv 3913
Energy consumption to DIN 58345	0.8 kWh/24h	1.5 kWh/24h
Temperature increase after a power failure from +5°C to +10°C	50 minutes	30 minutes

Range of appliance use

The appliance is designed for storing and cooling pharmaceuticals to DIN 58345 as long as the following conditions are satisfied:

- The appliance only complies with DIN 58345 if the battery of the power failure alarm integrated in the appliance is fully charged (see section entitled "Electrical connection").
- The appliances only satisfies the requirements of DIN 58345 with its factory temperature setting. If the temperature setting is adjusted (which can only be done by the service technician), its compliance with DIN 58345 will be void.

The appliance is **not** suitable for use in explosion-hazard areas.

Setting up

- Avoid positioning the appliance in direct sunlight or near cookers, radiators and similar sources of heat.
- The floor on which the appliance stands should be horizontal and level. Compensate for uneven floors with the adjustable feet.

• Do not cover ventilation openings or grille.

- Standard EN 378 specifies that the room in which you install your appliance must have a volume of 1 m³ per 8 g of R 600a refrigerant used in the appliance, so as to avoid the formation of inflammable gas/air mixtures in the room where the appliance is located in the event of a leak in the refrigerant circuit. The quantity of refrigerant used in your appliance is indicated on the type plate on the inside of the appliance.

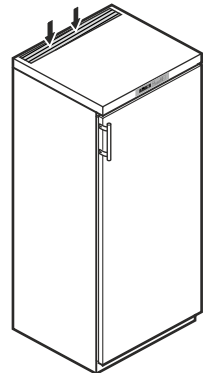

Appliance dimensions

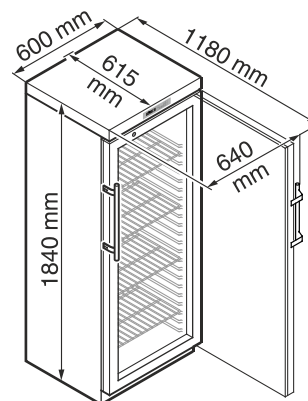

Electrical connection

Only operate the appliance with **alternating current (AC)**.

The permissible voltage and frequency are indicated on the type plate. The position of the type plate is shown in the section entitled **Description of the appliance**.

The socket must be properly earthed and protected by a fuse.

The tripping current of the fuse must be between 10 A and 16 A.

The socket must not be situated behind the appliance and must be easily accessible.

Do not connect the appliance using an extension cable or extension socket.

Do not use stand-alone inverters (conversion of direct current to alternating/three-phase current) or energy-saving plugs. Risk of damage to the electronic control system!

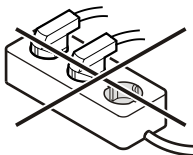

- Connect the appliance to the mains - the display reads **OFF**.



Note

It will take 24 hours for the batteries in the power failure alarm to become fully charged.

Instructions for decommissioning the appliance

When decommissioning the appliance, it is essential to follow the instructions in the section entitled "**Shutting your appliance down**".

Otherwise, the power failure alarm will be activated when the mains plug is disconnected.

Operating and control elements

- ① **ON/OFF** button (to switch the appliance on and off)
- ② Selection buttons
- ③ **Set** button (Enter)
- ④ **Audible warning** on/off button
- ⑤ Button for calling up stored alarm events
- ⑥ Temperature display
- ⑦ Interior light on/off button (MKv 3913)

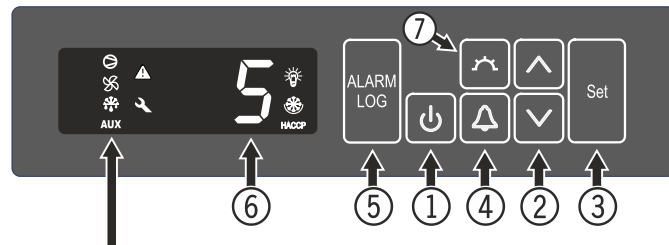

Symbols in the display

- Compressor is running
- LED flashing - refrigeration unit switches on after a delay. The compressor will start automatically after the pressure in the refrigerant circuit has equalised.
- Fan is running
- Appliance is defrosting
- AUX** Temperature display using reference sensor
- Interior light is switched on (MKv 3913)
- Alarm function
- If appears in the display, the appliance has a fault. Consult your nearest customer service point.

HACCP (Hazard Analysis Critical Control Point)

The **HACCP** display means that the power supply and interior temperature of the appliance are recorded.

If **HACCP** flashes in the display, there has either been a power failure or the temperature in the appliance exceeded the permissible range.

Interior temperature

The temperature inside the appliance is set to +5°C (+/-3K) as required by DIN 58345 and cannot be changed.

Important note

Items must not be stored in the appliance until the temperature has reached 5°C.

Switching the appliance on and off

Switching the appliance on



Keep the **ON/OFF** button  pressed for approx. 5 seconds - the display reads **ON**.

No alarm is displayed or sounded when the appliance is switched on for the first time.

If the appliance is disconnected from the mains for a long time after it has been switched on for the first time and if the temperature inside the appliance rises above the upper alarm limit, this will be detected as a fault by the electronic control system (**HACCP** appears in the display).

When the appliance is switched on again, this display must be reset as shown below.

Press button .

Press  +  for 5 seconds. The display will read **rE5**.

The **HACCP** LED will now light up permanently.

Press  for 5 seconds.

The electronic control system will switch back to normal operating mode.

Switching the appliance off

Keep the **ON/OFF** button  pressed for approx. 5 seconds - the display reads **OFF**.

Audible warning signal

The audible warning signal will sound in certain alarm events.

It can be cancelled by pressing button .

Power failure alarm

In the case of a power failure, the audible warning signal will sound and **bEP** will be shown in the display.



If **HACCP** appears in the refrigerator's display, the temperature has risen above the upper alarm limit of + 8°C.



Check the temperature progression as described in the section entitled

Calling up stored alarm events

and then make a decision on what you wish to do with the items stored in the refrigerator.

Door open alarm

When the door is opened, the LED  lights up and the temperature display begin to flash.

When the door has been left open for more than 60 seconds, the LED  begins to flash, and **door** and the temperature indication flash alternately in the display.

The audible warning signal sounds.

If the door has to stay open for longer in order to insert items to be cooled, cancel the audible warning signal by pressing button .

Setting the delay time for the door open alarm



The time before the audible warning signal sounds after the door has been opened can be adjusted.

Press  for 5 seconds. Display = **d6**

 Display = **d8d**

 Display = **!** (minute)

Setting range = 1 - 5 minutes

Use buttons  and  to select the desired setting.

 Display = **d8d**

Press  for 5 seconds.

The electronic control system will switch back to normal operating mode.

Audible warning signal settings

The audible warning signal will be muted for the current alarm after the button  has been pressed.

Complete the following steps if you want the audible warning signal to reactivate automatically.

Press  for 5 seconds. Display = **dB**

 Display = **tC**

 Display = **H4**

 Display = **HO**

 Display = **ASd**

 Display = **ASn**

 Display = **0**



 Display = **!**

 Display = **ASn**

Automatic reactivation of the audible warning signal is now active.

The time before the audible warning signal sounds again must be set.

 Display = **ASd**

 Display = **!** Time in minutes after which the audible warning signal will sound again after the button  has been pressed. Setting range = 1 - 120 minutes.

Use buttons  and  to select the desired setting.

 Display = **ASd**

Press  for 5 seconds.

The electronic control system will switch back to normal operating mode.

Alarm messages

1. LED flashes

If  appears in the display, the appliance has a fault.

Consult your nearest customer service point.

2. LED flashes and **bEE** appears in the display

The power failure alarm battery is supplying too low a voltage or is defective.

Consult your nearest customer service point.

3. LED flashes, the display reads **HI** or **LO**

The interior is too warm (HI) or too cold (LO).

The audible warning signal sounds.

4. HACCP flashes - the current interior temperature, **HF** and **Hi** are displayed alternately

There has been a power cut of some length or the interior was too warm or too cold during a certain period of time.

Up to three alarm events can be stored and called up.

Alarm test

This test checks the function of the internal and any external connected alarm device.

The appliance does not stop its refrigerating function during this test.

Activating the test

Press  +  for 5 seconds.

- The display will change to a temperature value of 0.2°C below the set upper alarm limit.
- The temperature value will now rise by 0.1°C every 2 seconds.
- When the upper alarm limit is reached, **HI0** will appear in the display. An external alarm unit connected to the floating alarm output will now be activated.
- The temperature value will continue to rise up to 0.2°C above the upper alarm limit.
- The same process will take place automatically for the lower alarm limit. **LI0** will appear in the display.

The LED  will be lit during the test.

The electronic control system will automatically switch back to normal operating mode.

Cancelling the test prematurely

Press  for 5 seconds.

Calling up stored alarm events and reading the temperature progression

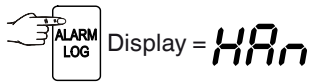

Scroll through the list using or .

- HA n** Number of temperature alarms
- HA** Last temperature alarm
- HA 1** Last temperature alarm but one
- HA 2** Temperature alarm before **HA 1**
- HF n** Number of power cuts
- HF** Last power cut
- HF 1** Last power cut but one
- HF 2** Power cut before **HF 1**
- r t** Period in hours in which the maximum and minimum interior temperatures were measured
- r H** Maximum (highest) measured temperature
- r L** Lowest measured temperature

Select the required item using the button. Press this button again to return to the list.

Note: You can exit the menu at any time by pressing for 5 seconds.

If no button is pressed within 60 seconds, the electronic control system switches back automatically.

Resetting the recorded temperature progression r t

Complete the following steps if you wish to reset the value saved for **r t** in the previous section to 0.

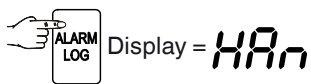

Press the button or until **r t** appears in the display.

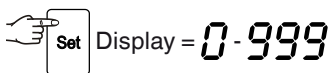

Press for 5 seconds. Display = **r ES**.

The values for **r H** and **r L** (highest and lowest measured interior temperature) are then reset to the current interior temperature.

Press for 5 seconds.

The electronic control system will switch back to normal operating mode.

Example of an alarm query

Situation: HACCP flashes in the display.

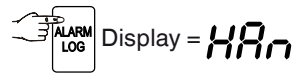

Display = **0** There has not been an alarm status with a too high or too low temperature. You must switch to display **HF n**.

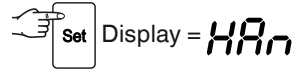

Press this button until **HF n** appears in the display.

Display = **1 1** power failure has occurred.

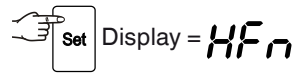

Display = **HF** Last power failure.

Display = **Y 14** Year 2014

Display = **n 05** Month 05 (May)

Display = **d 30** Day 30

Display = **h 23** Hour 23

Display = **n 14** Minute 14

Display = **t 03** The power failure lasted 3 hours.

Press + for 5 seconds. The display will read **r ES**.

The HACCP LED will now light up permanently.



The electronic control system is now ready for the next alarm.

Press for 5 seconds.



The electronic control system will switch back to normal operating mode.

Changing the network address



When connecting several appliances via the RS485 interface, each appliance must have its own network address.



Press   for 5 seconds. Display = **dB**

  Display = **tc**

  Display = **HO**

  Display = **!**

Use buttons  or  to change the network address (**1-207**).

  Display = **HO**



Press   for 5 seconds.

The electronic control system will switch back to normal operating mode.



Resetting the parameters to factory settings

The **alarm limits** and **sensor calibration values** can be reset to the factory settings using this function.

Pull out the mains plug.

Keep   pressed and connect the mains plug.



Display = **bn !**

  Display = **Std**



The electronic control system will switch back to normal operating mode.





Setting the real time clock



The real time clock is preset (CET). Other time zones or summer/winter time must be adjusted manually.

Press   for 5 seconds. Display = **dB**





  Display = **tc**



  Display = **Y 14** Year 2014



  Display = **10** Set the year by pressing the   buttons.





  = save new setting



  Display = **NO 7** Month (1-12)



  Display = **7** Set the month by pressing the   buttons.





  = save new setting



  Display = **DO 1** Day (1-31)

  Display = **!** Set the day by pressing the   buttons.





  = save new setting



  Display = **U03** Days of the week (1 = Monday, 7 = Sunday)



  Display = **3** Set the day of the week by pressing the   buttons.





  = save new setting



  Display = **h 12** Hour (0-23)

  Display = **12** Set the hour by pressing the   buttons.

  = save new setting

  Display = **n 48** Minute (0-59)

  Display = **48** Set the minutes by pressing the   buttons.

  = save new setting

Press   for 5 seconds.

The electronic control system will switch back to normal operating mode.

Note

When **tc** appears in the display, the real time clock must be reset.

Interior light MKv 3913

The interior light is fitted on the inside at the top.

The interior light can be switched on and off using the  button.

The light intensity of the LED light corresponds to laser class 1/1M.

Important

The light cover may only be removed by customer service staff.

If the cover is removed, do not look directly at the light through optical lenses from close distance.

This can damage your eyes.

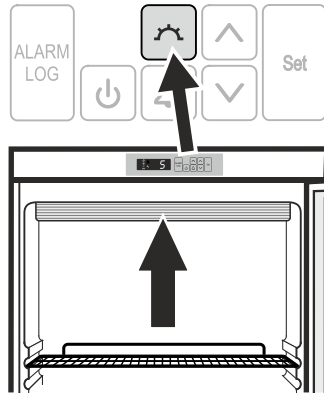

Safety lock

The lock in the appliance door is equipped with a safety mechanism.

Locking the appliance

- Insert the key as shown by arrow **1**.
- Turn the key 90°.

To unlock the appliance, the same procedure must be repeated in the same order.

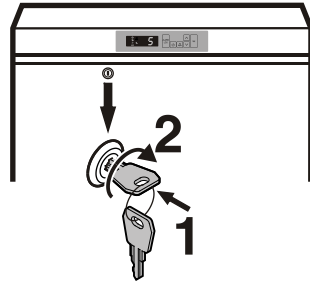



Defrosting



The appliance defrosts automatically. The water that forms on the rear wall drains into a reservoir at the back of the appliance and evaporates automatically through the compressor heat.

Setting the display indication for the defrost phase



The following indications can be set for the defrost phase.

- Symbol  + alternating display of *dEF* and the current temperature in the interior of the appliance.
- Symbol  + temperature before the start of the defrost phase (factory setting).
- Symbol  + *dEF*.

Change the display during the defrost phase

Press   for 5 seconds. Display = *dB*

 Display = *!*

Use buttons  and  to select the desired setting.

0 = alternating display of *dEF* and the current temperature in the interior of the appliance.

! = temperature before the start of the defrost phase.

2 = display of *dEF* only.

 Display = *dB*

Press   for 5 seconds.

The electronic control system will switch back to normal operating mode.

Cleaning and disinfection

Always switch off the appliance before cleaning and disinfecting it.

Disconnect the appliance from the mains.

- Only disinfect the appliance with ethyl alcohol-based products.
- First clean the soiled areas and grid shelves with a damp cotton cloth.
- Clean the interior container, grid shelves and outer walls with lukewarm water, ethyl alcohol-based cleaning products or water-based household cleaning products.

Do not use chemical solvents or any cleaning agents containing sand or acid.

Do not use steam cleaners because of the risk of injury and damage.

- Ensure that no cleaning water penetrates into the electrical components or ventilation grille. →
- The dust should be removed from the refrigeration unit and heat exchanger - metal grid at the back of the appliance - once a year. →

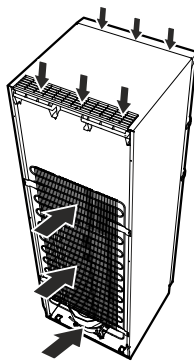

- Do not damage or remove the type plate on the inside of the appliance. It is very important for servicing purposes.
- The appliance's materials are only resistant to the cleaning products listed above.
- Regular cleaning and disinfection prevents severe soiling.

Malfunctions

You may be able to rectify the following faults by checking the possible causes yourself:

- **Appliance does not function:**
 - Is the appliance switched on?
 - Is the plug correctly fitted in the mains socket?
 - Is the fuse intact?
- **Loud running noise:**
 - Is the appliance set up firmly on the floor?
 - Does the appliance cause nearby items of furniture or objects to vibrate? Please note that noises caused by the refrigerant circuit cannot be avoided.
- **The temperature is not low enough:**
 - Is the temperature setting correct (see "Setting the temperature")?
 - Does the separately installed thermometer show the correct reading?
 - Is the ventilation system working properly?
 - Is the appliance set up too close to a heat source?
- **Etc** appears in the display:
 - Reset the real time clock (see "Setting the real time clock").

If none of the above causes apply and you cannot rectify the fault yourself, contact the nearest customer service department stating the type designation ①, service number ② and appliance number ③ as indicated on the type plate.

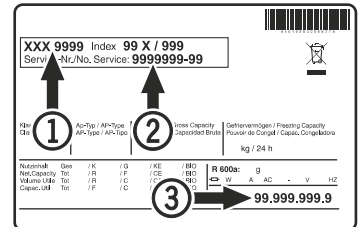

The position of the type plate is shown in the section entitled **Description of the appliance**.

Shutting your appliance down

If the appliance is to be left switched off for any length of time, complete the following steps to disconnect the power failure alarm battery from the electronic control system.

- Keep the **ON/OFF** button pressed for approx. 5 seconds - the display reads **OFF**.

- Press + for 5 seconds.

> The display will read **bEt0**.

- Remove the plug.
- Clean the appliance and leave the door open in order to prevent unpleasant smells.

The appliance complies with the relevant safety regulations and EC Directives 2004/108/EC and 2006/95/EC.

External alarm

We recommend connecting the appliance to an external alarm device.

There are various connection options at the back of the appliance.

The appliance may only be connected to an external alarm device by trained personnel.

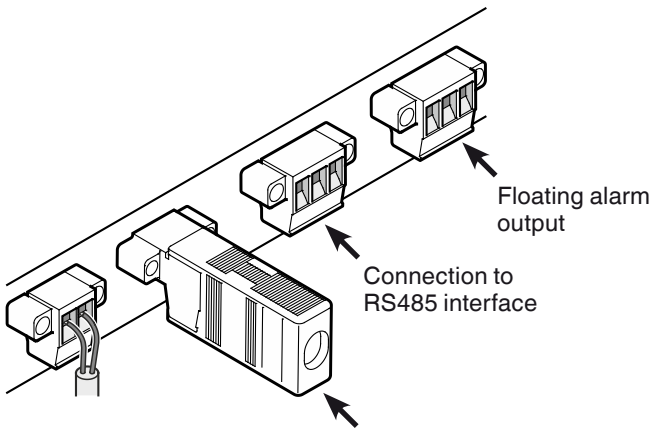
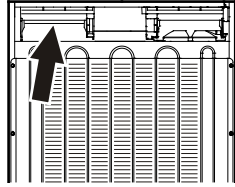

Terminating resistor

When connecting several appliances via the RS485 interface, the terminating resistor must remain on the last appliance.

Remove the terminating resistors from the appliances in between.

Note

The connectors are secured with screws. To remove the connectors, undo the left and right screws.

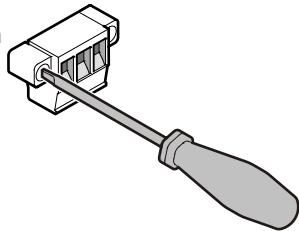

Floating alarm output

These three contacts can be used to connect the appliance to an optical or acoustic alarm device.

The connection is designed for a maximum of **42 V/8 A DC** from a safety extra-low voltage (SELV) source (**minimum current: 150 mA**).

Important

When supplying mains voltage to the floating alarm contact, the technical safety requirements of standard EN 60335 will not be satisfied.

N.O

Alarm output

Connection for a visual warning light or an acoustic alarm signal.

N.C

Operating light

Connection for a control lamp to indicate that the appliance is in normal mode.

COM

External power supply unit

42 V/8 A DC maximum
Minimum current: 150 mA

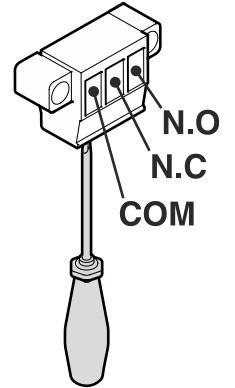

RS485 interface

Rx- / Tx-

Send/Receive data cable (negative pole)

Rx+ / Tx+

Send/Receive data cable (positive pole)

GND

Earth cable

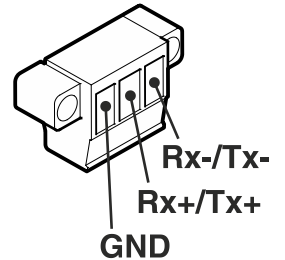

Changing over door hinges

1. Unscrew the hinge bracket.

Important: The door mounting has a spring mechanism enabling the door to close by itself. The hinge bracket turns to the left when the screws are undone.

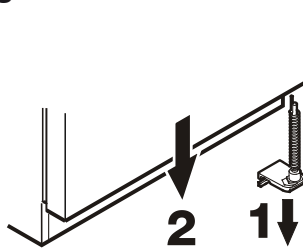

2. Pull the door out at the bottom and lift off.

3. Transfer handle and plugs to the opposite side of the door.

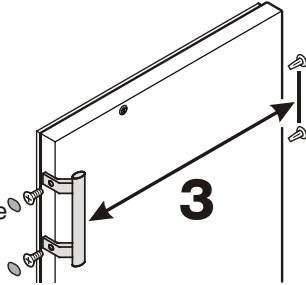

4. Transfer pin on hinge bracket to the opposite side.



5. Transfer upper hinge components to the opposite side.

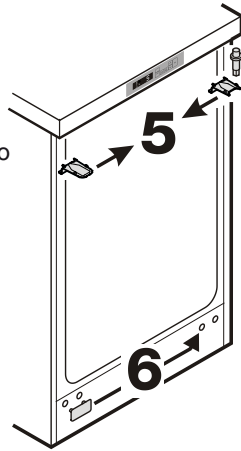

6. Transfer cover plate to the opposite side.

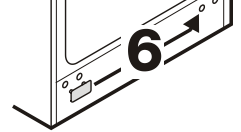

7. Mount door on hinge pin and close.

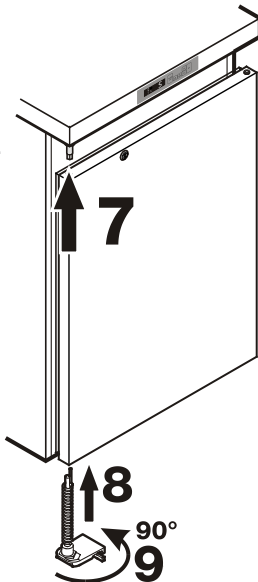

8. Insert hinge bracket in lower door mounting.

9. Turn hinge bracket by 90° - spring is compressed. Screw on hinge bracket.