

# Original operating instructions

Refrigerator

Read the operating instructions before switching on for the first time

Page 16

EN

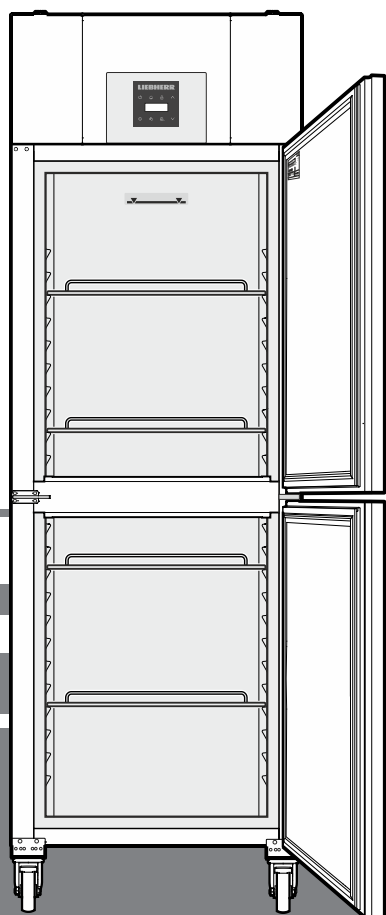

LKPv 6527

**7085 627-01**

**LIEBHERR**

## Content

Priority of warnings.....	16
Safety instructions and warnings .....	16
Symbols on the appliance .....	17
Intended use.....	17
Foreseeable incorrect use.....	17
Declaration of conformity .....	17
Noise emissions from the appliance .....	17
Climate rating .....	18
Description of the appliance.....	18
Setting up .....	18
Levelling the appliance.....	18
Electrical connection.....	18
Appliance dimensions .....	18
Equipment .....	19
Back-up battery .....	19
Operating and control elements.....	19
Power failure alarm.....	19
Switching the appliance on and off .....	20
Setting the temperature.....	20
Temperatur display mode.....	20
Door open alarm.....	20
Setting the delay time for the door open alarm.....	20
Audible warning signal settings.....	20
Deactivating the audible warning signal function .....	21
Alarm test .....	21
Alarm messages .....	21
Adjusting the alarm parameters .....	21
Calling up stored alarm events and reading the temperature progression.....	22
Resetting the stored alarm events HAn.....	22
Resetting the recorded temperature progression rt .....	22
Example of an alarm query .....	22
Calibrating the control sensor .....	22
Product sensor (available accessory) .....	23
Activation of the product sensor.....	23
Calibrating the product sensor .....	23
Switching the temperature display between control sensor and product sensor.....	23
Changing the network address .....	23
Keypad lock.....	24
Resetting the parameters to factory settings .....	24
Setting the real time clock .....	24
Conversion from summer to winter time.....	24
Enabling/disabling automatic conversion from summer to winter time .....	24
Defrosting.....	25
Activating the defrost function manually .....	25
Setting the display indication for the defrost phase .....	25
External alarm .....	25
Cleaning .....	25
Malfunctions.....	26
Shutting your appliance down.....	26
Disposal notes.....	26
Possible error messages in the display.....	26
Changing over door hinges .....	27

## Priority of warnings

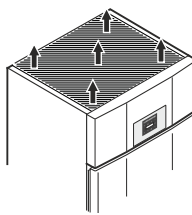

<b>⚠ DANGER</b>	identifies a situation involving direct danger which, if not obviated, may result in death or severe bodily injury.
<b>⚠ WARNING</b>	identifies a dangerous situation which, if not obviated, may result in death or severe bodily injury.
<b>⚠ CAUTION</b>	identifies a dangerous situation which, if not obviated, may result in minor or medium bodily injury.
<b>NOTICE</b>	identifies a dangerous situation which, if not obviated, may result in damage to property.
<b>Note</b>	identifies useful information and tips.

## Safety instructions and warnings

- **WARNING:** do not seal ventilation openings on the appliance housing or enclosure. 
- **WARNING:** only use the mechanical devices or other aids recommended by the manufacturer to help speed up the defrosting process.
- **WARNING:** do not damage the refrigerant circuit.
- **WARNING:** do not use any electrical devices in the refrigerator compartment which do not comply with the design recommended by the manufacturer.
- **WARNING:** the mains cable must not be damaged while installing the appliance.
- **WARNING:** multi-sockets or distributor strips and other electronic devices (such as halogen transformers) must not be positioned and operated at the rear of appliances.
- **WARNING:** this appliance must be secured as described in the operating instructions to rule out any potential risks due to its instability.
- This appliance can be used by children of 8 years old and over, and also by persons with restricted physical, sensory or mental capacity or lack of experience and knowledge, if they are supervised or have been instructed on safe use of the appliance and understand the resulting risks. Children must not be allowed to play with the appliance. Cleaning and user maintenance must not be carried out by children without supervision.
- Do not store any explosive substances, such as aerosol containers with flammable propellant gas, inside the appliance.
- To prevent injury and damage to property, the appliance should only be installed by two people.

- After unpacking it, check the appliance for signs of damage. Contact the supplier if it is damaged. Do not connect the appliance to the mains power supply.
- Avoid prolonged skin contact with cold surfaces (e.g. chilled/frozen products). If necessary, take safety action (e.g. gloves).
- All repairs and work on the appliance may only be carried out by customer service personnel or other trained personnel. The same applies to changing the mains power cable.
- Only carry out repair and other work on the appliance when the mains plug has visibly been disconnected.
- Only install, connect and dispose of the appliance as described in these operating instructions.
- In the event of a fault, pull out the plug or switch off the fuse.
- When disconnecting the appliance from the mains, pull on the plug. Do not pull on the cable.
- Do not allow naked flames or ignition sources to enter the appliance.

## Symbols on the appliance

	The symbol can be located on the compressor. It refers to the oil in the compressor and indicates the following danger: swallowing or inhaling can be fatal. This is only relevant for recycling. There is no danger in normal operation.
	Warning about inflammable substances.
	A sticker to this effect may be applied to the rear of the appliance. It refers to the foampadded panels in the door and/or the housing. This is only relevant for recycling. Do not remove the sticker.

## Intended use

This universal laboratory refrigerator for professional use is suitable for storing products at temperatures between -2°C and +16°C.

Typical products for storage include research samples, reagents, laboratory inventory, etc.

For the storage of valuable or temperature-sensitive substances or products the use of an independent, constantly monitoring alarm system is necessary.

This alarm system must be designed so that each alarm status is detected immediately by an authorised person who can then take appropriate action.

## Foreseeable incorrect use

Do not use the appliance for the following applications:

- Storage and cooling of
  - chemically unstable, inflammable or caustic substances
  - blood, plasma or other bodily fluids for the purposes of infusion, application or insertion into the human body.
- Use in potentially explosive atmospheres.
- Use outdoors or in areas where it is exposed to splash water or damp conditions.

Incorrect use of the appliance will result in damaging or spoiling the goods stored in it.

## Declaration of conformity

The refrigerant circuit has been tested for leaks. The appliance complies with the relevant safety regulations and EU Directives 2006/42/EG, 2014/30/EU, 2009/125/EG and 2011/65/EU.

## Noise emissions from the appliance

The noise level while the appliance is operating is below 70 dB(A) (relative noise level 1 pW).





## Equipment

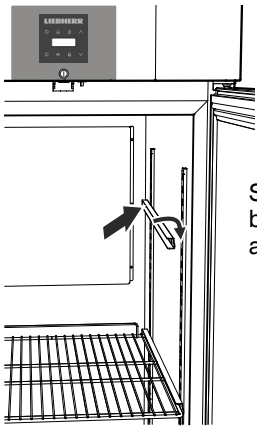

Suspend the rails at the desired height, by inserting into the rear clip-in strip first and then clipping in at the front.

## Safety lock

The lock is equipped with a safety mechanism.

### Locking the appliance

- Insert the key as shown by arrow 1.
- Turn the key 180° (2).

To unlock the appliance, the same procedure must be repeated in the same order.

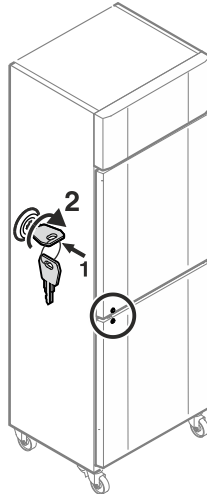

## Back-up battery

Before the appliance is switched on, the battery which is fitted in the compressor compartment must be connected.

This battery ensures that alarms are always reported, even in the event of a power failure.

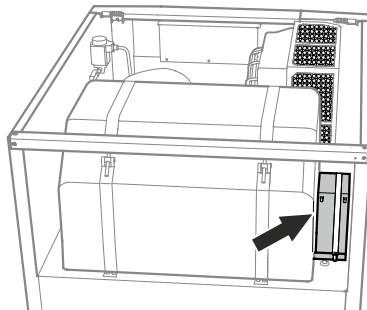

### Important!

**The appliance must not be connected to the electrical power supply yet.**

Remove cover.

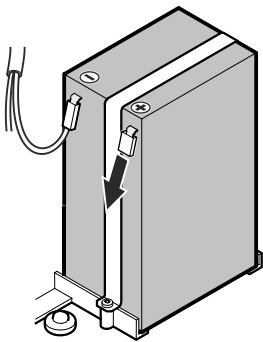

Plug the connector onto the positive pole on the battery.

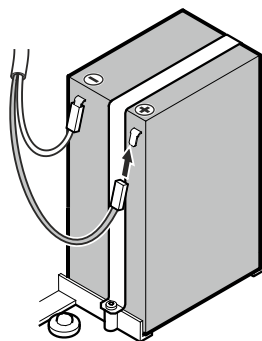

## Disposal instructions for batteries

The battery must be removed when you wish to dispose of the appliance and sent for separate waste treatment for batteries.

**Do not damage or short circuit the battery.**

## Operating and control elements



- On/Off button (switching the appliance on and off)
- Button for calling up stored alarm events
- Keypad lock
- Selection buttons
- Audible alarm Off button
- Defrost button (for manually activating the defrost function)
- Enter button

## Symbols in the display

- Compressor is running
- LED flashing - refrigeration unit switches on after a delay. The compressor will start automatically after the pressure in the refrigerant circuit has equalised.
- Fan is running
- Appliance is defrosting
- Temperature display via product sensor is activated
- LED flashing and **E t C** appears in the display. The real time clock must be reset.
- The **H** display means that the power supply and interior temperature of the appliance are recorded.
- If **H** flashes in the display, there has either been a power failure or the temperature in the appliance exceeded the permissible range.
- SuperCool is activated
- Alarm function
- The appliance has suffered a fault. Contact the customer service department.

## Power failure alarm

In the case of a power failure, the audible warning signal will sound and **b t P** will be shown in the display.

If **H** appears in the refrigerator's display, the temperature has risen above the upper alarm limit of + 8°C.

Check the temperature progression as described in the section entitled **Calling up stored alarm events** and then make a decision on what you wish to do with the items stored in the refrigerator.

## Switching the appliance on and off

Connect the appliance to the mains. Display = **OFF**.

### Switching the appliance on

Press  for approx. 5 seconds. Display = **ON**.

No alarm is displayed or sounded when the appliance is switched on for the first time.

If the appliance is disconnected from the mains for a long time after it has been switched on for the first time and if the temperature inside the appliance rises above the upper alarm limit, this will be detected as a fault by the electronic control system ( flashes in the display).

When the appliance is switched on again, this display must be reset as shown below.

Press .

Press  +  for 5 seconds. Display = 

The  LED will now light up permanently.

Press  for 5 seconds.

The electronic control system will switch back to normal operating mode.

### Switching the appliance off

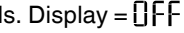
Press  for approx. 5 seconds. Display = 

## Setting the temperature

Press  for 1 second. The temperature display flashes.

To increase the temperature (warmer): press button .

To reduce the temperature (colder): press button .

Press  again.



The desired temperature setting is saved.

## Temperatur display mode

The temperature display can be switched between degrees Celsius and degrees Fahrenheit. Factory setting is degrees Celsius.

Press  for 5 seconds. Display = 

Press . Display = 

Use button  or  to select the desired setting.

0 = °C

1 = °F



Press . Display = 

Press  for 5 seconds.

The electronic control system will switch back to normal operating mode.

## Door open alarm

When the door is opened, the LED  lights up and the temperature display begins to flash.

When the door has been left open for more than 60 seconds, the LED  begins to flash, and  and the temperature indication flash alternately in the display.

The audible warning signal sounds (unless the audible warning signal function has been deactivated).

If the door has to stay open for longer in order to insert items to be cooled, cancel the audible warning signal by pressing button .

### Note

The door opening alarm only works for the top door.



## Setting the delay time for the door open alarm

The time before the audible warning signal sounds after the door has been opened can be adjusted.

Press  for 5 seconds. Display = 

Press  until  appears in the display.

Press . Display =  Setting range = 1 - 5 minutes.

Use button  or  to select the desired setting.

Press . Display = 

Press  for 5 seconds.

The electronic control system will switch back to normal operating mode.

## Audible warning signal settings

The audible warning signal will be muted for the current alarm after the button  has been pressed. Complete the following steps if you want the audible warning signal to reactivate automatically.

Press  for 5 seconds. Display = 

Press  until  appears in the display.

Press . Display = 

Press . Display = 



Press . Display = 

Automatic reactivation of the audible warning signal is now active.

The time before the audible warning signal sounds again must be set.

Press . Display = 

Press . Display =  Setting range = 1 - 120 minutes.

Use button  or  to select the desired setting.

Press . Display = 

Press  for 5 seconds.

The electronic control system will switch back to normal operating mode.



## Deactivating the audible warning signal function

The audible warning signal function can be completely deactivated if necessary.

Press  for 5 seconds. Display = r15

Press  until H4 appears in the display.

Press . Display = 0

Use button  or  to select the desired setting.

0 = audible warning signal function activated

1 = audible warning signal function deactivated

Press . Display = H4

Press  for 5 seconds.

The electronic control system will switch back to normal operating mode.

## Alarm test

This test checks the function of the internal and any external connected alarm device.

The appliance does not stop its refrigerating function during this test.

Press  +  for 5 seconds.

- The display will change to a temperature value of 0.2°C below the set upper alarm limit.
- The temperature value will now rise by 0.1°C every 2 seconds.
- When the upper alarm limit is reached, H10 will appear in the display. An external alarm unit connected to the floating alarm output will now be activated.
- The temperature value will continue to rise up to 0.2°C above the upper alarm limit.
- The same process will take place automatically for the lower alarm limit. L10 will appear in the display.

The LED  will be lit during the test.

The electronic control system will switch back to normal operating mode.

### Cancelling the test prematurely

Press  for 5 seconds.

#### Note

If the values of the upper and lower alarm limit (**AL** and **AH** in the section entitled "Adjusting the alarm parameters") are set to 0, H- - and L- - will appear in the display during this test.

## Alarm messages

### 1. LED flashes in the display

If  appears in the display, the appliance has a fault. Consult your nearest customer service point.

### 2. LED flashes in the display; the display reads HI or LO

The interior is too warm (HI) or too cold (LO).

The audible warning signal sounds (unless the audible warning signal function has been deactivated).

#### Note

The alarm parameters can be adjusted. See **Adjusting the alarm parameters**.

### 3. HA / HF / flashes in the display

There has been a power cut (**HF**) of some length or the interior was too warm or too cold (**HA**) during a certain period of time.

Up to three alarm events can be stored and called up.

## Adjusting the alarm parameters



The alarm limits (difference to the set temperature) and the alarm delay (delay until alarm sounds) can be adjusted.

Press  for 5 seconds. Display = r15

Press  until AL appears in the display.

AL = Lower alarm limit

Press . Display = temperature difference in °C



Use button  or  to select the desired setting.

### Set positive values only.

Press . Display = AL

Press . Display = AH Upper alarm limit

Press . Display = temperature difference in °C



Use button  or  to select the desired setting.

### Set positive values only.

Press . Display = AH

Press . Display = AL

Press . Display = alarm delay in minutes

Use button  or  to select the desired setting.

Press . Display = AL

Press  for 5 seconds.

The electronic control system will switch back to normal operating mode.

## Calling up stored alarm events and reading the temperature progression

Press . Display = HFA1

Scroll through the list using  $\nabla$  or  $\blacktriangle$ .

HFA1 Number of temperature alarms

HA Last temperature alarm

HA | Last temperature alarm but one

HFA2 Temperature alarm before HA |

HF1 Number of power cuts

HF Last power cut

HF | Last power cut but one

HF2 Power cut before HF |

rE Period in hours in which the maximum and minimum interior temperatures were measured

rH Maximum (highest) measured temperature

rL Lowest measured temperature

Select the required item using the button. Press this button again to return to the list.

You can exit the menu at any time by pressing for 5 seconds.

If no button is pressed within 60 seconds, the electronic control system switches back automatically.

## Resetting the stored alarm events HAN

Press . Display = HFA1

Press +  $\blacktriangle$  for 5 seconds. Display = rE5.

Press for 5 seconds.

The electronic control system will switch back to normal operating mode.

## Resetting the recorded temperature progression rt

Press . Display = HFA1

Press the button  $\nabla$  or  $\blacktriangle$  until rE appears in the display.

Press . Display = 0-999

Press  $\nabla$  for 5 seconds. Display = rE5.

The values for rH and rL (highest and lowest measured interior temperature) are then reset to the current interior temperature.

Press for 5 seconds.

The electronic control system will switch back to normal operating mode.

## Example of an alarm query

Situation: HA/HF/ flashes in the display.

Press . Display = HFA1

Press . Display = 0

There has not been an alarm status with a too high or too low temperature. You must switch to display HF1.

Press . Display = HFA1

Press  $\blacktriangle$  until HF1 appears in the display.

Press . Display = | 1 power failure has occurred.

Press . Display = HF1

Press  $\blacktriangle$ . Display = HF Last power failure.

Press . Display = 300 (year)

Press  $\blacktriangle$ . Display = 100 (month 1-12)

Press  $\blacktriangle$ . Display = 100 (day 1-31)

Press  $\blacktriangle$ . Display = 100 (hour 0-23)

Press  $\blacktriangle$ . Display = 100 (minute 0-59)

Press  $\blacktriangle$ . Display = 100 (period of time in minutes)

Press +  $\blacktriangle$  for 5 seconds. Display = rE5

The LED will now light up permanently.

HA/HF is cancelled in the display.

The electronic control system is now ready for the next alarm.

Press for 5 seconds.

The electronic control system will switch back to normal operating mode.

## Calibrating the control sensor

(standard sensor for temperature control)

Possible tolerances of the control sensor (the displayed temperature compared to the actual interior temperature) can be offset with this function.

Press for 5 seconds. Display = rE5

Press  $\blacktriangle$  until rE appears in the display.

Press . Display = correction value set at the factory

Use button  $\nabla$  or  $\blacktriangle$  to increase or decrease the correction value in 0.1°C increments.

Press . Display = actual (corrected) interior temperature

Press . Display = rE5

Press for 5 seconds.

The electronic control system will switch back to normal operating mode.

## Product sensor (available accessory)

The temperature may be measured or recorded at any point in the interior using the product sensor.

### Remove the plug!

1. Feed the sensor through the opening in the compressor compartment and position inside the appliance.

### Seal the opening with sealant.

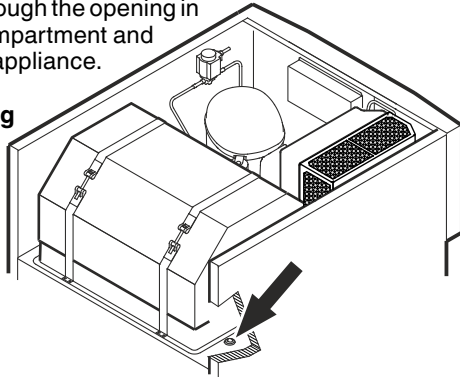

2. Undo the screw on the underside of the front panel. Tilt the front panel upwards.

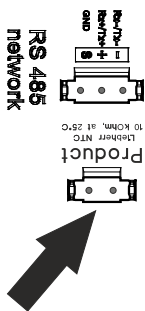
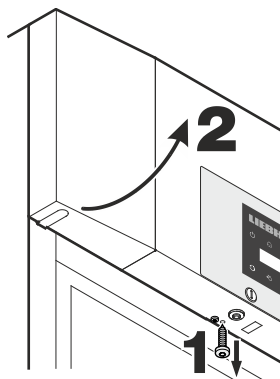

3. Plug in the product sensor plug.

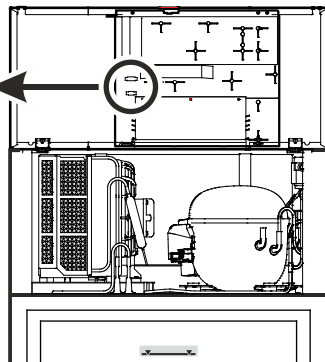

4. Close the front panel and fix with the screw.

### Activation of the product sensor

Press for 5 seconds. Display = r<sup>1</sup>⏏

Press until r<sup>1</sup>⏏ appears in the display.

Press . Display =

Press . Display =

Press . Display = r<sup>1</sup>⏏

Press for 5 seconds.

The electronic control system will switch back to normal operating mode.

If appears in the display, the product sensor has not been activated.

If appears in the display, the product sensor has not been connected, or is faulty.

### Calibrating the product sensor

Possible tolerances of the product sensor (the displayed temperature compared to the actual interior temperature) can be offset with this function.

Press for 5 seconds. Display = r<sup>1</sup>⏏

Press until r<sup>1</sup>⏏ appears in the display.

Press . Display =

Use button or to increase or decrease the correction value in 0.1°C increments.

Press . Display = actual (corrected) product sensor temperature

Press . Display = r<sup>1</sup>⏏

Press for 5 seconds.

The electronic control system will switch back to normal operating mode.

### Switching the temperature display between control sensor and product sensor

Press for 5 seconds. Display = r<sup>1</sup>⏏

Press until r<sup>1</sup>⏏ appears in the display.

Press . Display =

Press . Display =

If the product sensor is activated, appears in the display.

Press . Display = r<sup>1</sup>⏏

Press for 5 seconds.

The electronic control system will switch back to normal operating mode.

### Changing the network address

When connecting several appliances via the RS485 interface, each appliance must have its own network address.

Press for 5 seconds. Display = r<sup>1</sup>⏏

Press until H appears in the display.

Press . Display =

Use button or to change the network address (1-207).

Press . Display = H

Press for 5 seconds.

The electronic control system will switch back to normal operating mode.

## Keypad lock



The keypad lock ensures that no unintentional changes are made to the electronic control system.

### Setting a PIN code for the keypad lock function

Press  for 5 seconds. Display = r<sup>1</sup>5

Press  until P | appears in the display.

Press . Display = |

Use button  or  to choose a PIN code between 1 and 999.



Press . Display = P |

Press  for 5 seconds.

The electronic control system will switch back to normal operating mode.

### Activating the keypad lock

Press  for 5 seconds. Display = |

Use button  or  to select the PIN code.



Press . Display = |000

All buttons except  and  are locked.

If an incorrect PIN code is entered, the electronic control system switches back to normal operation without activating the keypad lock.

### Deactivating the keypad lock

Press  for 5 seconds. Display = |

Use button  or  to select the PIN code.

Press . Display = |000

All functions are enabled.

If an incorrect PIN code is entered, the keypad lock remains active.

## Resetting the parameters to factory settings

The alarm limits and sensor calibration values can be reset to the factory settings using this function.

Keep the  button pressed for approx. 5 seconds.

The **OFF** indicator and the temperature display flash alternately.

Remove the connector of the battery. 

Pull out the mains plug.

Plug the connector onto the positive pole on the battery.

Keep  pressed and connect the mains plug.

Display = 000 |

Press . Display = 500 |

The electronic control system will switch back to normal operating mode.

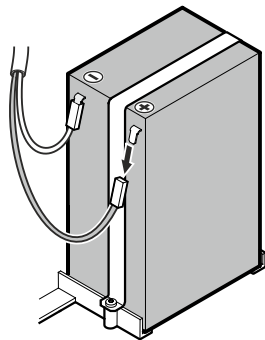

## Setting the real time clock



The real time clock is preset (CET). For a different time zone, the time must be adjusted manually.

Press  for 5 seconds. Display = r<sup>1</sup>5

Press . Display = 000 |



Press . Display = 000 (year)

Press . Display = 00

Set the year by pressing the   buttons. Press .

Press . Display = 000 (month 1-12)

Press . Display = 00

Set the month by pressing the   buttons. Press .

Press . Display = 000 (day 1-31)



Press . Display = 00

Set the day by pressing the   buttons. Press .

Press . Display = 000 (days of the week)



(1 = Monday, 7 = Sunday)

Press . Display = 00

Set the day of the week by pressing the   buttons. Press .



Press . Display = 000 (hour 0-23)

Press . Display = 00

Set the hour by pressing the   buttons. Press .

Press . Display = 000 (minute 0-59)

Press . Display = 00

Set the minutes by pressing the   buttons. Press .

Press  for 5 seconds. The electronic control system will switch back to normal operating mode.

When 000 | appears in the display, the real time clock must be reset.

## Conversion from summer to winter time



Conversion to summer time is carried out automatically by the electronic control system on the last Sunday in March at 2 o'clock in the morning. Conversion to winter time is carried out automatically by the electronic control system on the last Sunday in October at 2 o'clock in the morning. In order to enable the new time, the appliance must be switched off and on after each of the times specified above.

### Enabling/disabling automatic conversion from summer to winter time

Press  for 5 seconds. Display = r<sup>1</sup>5

Press  until 000 | appears in the display.

Press . Display = |

Use button  or  to select the desired setting.

0 = deactivated 1 = activated

Press . Display = 000 |

Press  for 5 seconds. The electronic control system will switch back to normal operating mode.





## Defrosting

The refrigerator defrosts automatically.

### Activating the defrost function manually

If the door has been left slightly open for a long time, a layer of ice may form in the interior and on the cooling plate. The defrost function can then be activated manually.

Press  for 3 seconds. Display =  + dFE

The electronic control system will automatically switch back to normal operating mode.



Display = dFE

### Setting the display indication for the defrost phase

Press  for 5 seconds. Display = r<sup>1</sup>5

Press  until  appears in the display.



Press . Display = |

Use button  or  to select the desired setting.

0 = Symbol  + alternating display of dFE and the current temperature in the interior of the appliance.

1 = Symbol  + temperature before the start of the defrost phase.

2 = Symbol  + dFE.

Press . Display = 

Press  for 5 seconds. The electronic control system will switch back to normal operating mode.

## External alarm

The appliance can be connected to an external alarm device.

A floating alarm contact and an RS485 interface are available.

A refitting kit for serial data evaluation via the RS485 interface is available from your dealer or our customer service department.

## Cleaning

### WARNING

Before cleaning, always disconnect the appliance from the mains. Pull out the plug or switch off the fuse.

### CAUTION

Risk of damage to the appliance components and risk of injury due to hot steam.

Do not use steam cleaning equipment to clean the appliance.

### NOTICE

Surfaces which may come into contact with food and accessible drain systems must be cleaned at regular intervals.

- Clean the inside, equipment parts and outer walls with lukewarm water and a little detergent. Do not use chemical solvents or any cleaning agents containing sand or acid.
- To avoid short-circuits, ensure no cleaning water penetrates into the electrical components when cleaning the appliance.
- Dry all parts well with a cloth.
- Use a commercially available stainless-steel cleaning agent for stainless-steel appliances.
- Do not damage or remove the type plate on the inside of the appliance. It is very important for servicing purposes.

### Cleaning the dust filter

Clean the dust filter at least twice per year!

#### Remove the plug!

1. Remove the dust filter by lifting upwards.
2. Clean the dust filter with water and detergent.
3. Reinstall the dust filter.

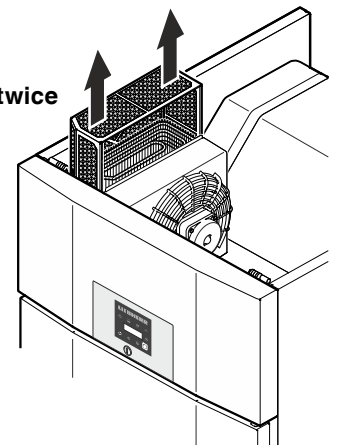



## Malfunions

You may be able to rectify the following faults by checking the possible causes yourself:

- **Appliance does not function:**

- Is the appliance switched on?
- Is the plug correctly fitted in the mains socket?
- Is the fuse intact?

- **The temperature is not low enough:**

- Is the temperature setting correct (see "Setting the temperature")?
- Does the separately installed thermometer show the correct reading?
- Is the ventilation system working properly?
- Is the appliance set up too close to a heat source?

If none of the above causes apply and you cannot rectify the fault yourself, contact the nearest customer service department stating the type designation ①, service number ② and appliance number ③ as indicated on the type plate.

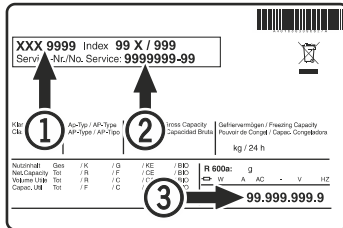

The position of the type plate is shown in the section entitled **Description of the appliance**.

## Shutting your appliance down

If the appliance is left empty for a lengthy period, it must be switched off, defrosted, cleaned and dried and the door is to be left open to prevent mould formation.

Complete the following steps to disconnect the power failure alarm battery from the electronic control system.

- Keep the **⏻** button pressed for approx. 5 seconds.
- The **OFF** indicator and the temperature display flash alternately.
- Remove the connector of the battery. →

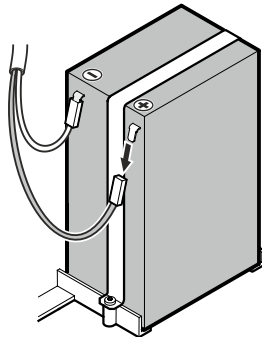

## Disposal notes

The appliance contains reusable materials and should be disposed of properly - not simply with unsorted household refuse. Appliances which are no longer needed must be disposed of in a professional and appropriate way, in accordance with the current local regulations and laws.



Do not damage the refrigerant circuit of an appliance that is no longer needed during its disposal.

This appliance contains inflammable gases in the refrigerant circuit and insulation foam.

Your local council or a waste disposal contractor can provide information about how to dispose of the appliance correctly.

## Possible error messages in the display

Error code	Error	Action
E0, E1, E2, rE	Temperature sensor defective	Contact the customer service department
EE, EF	Electronic control system error	Contact the customer service department
dOr	Appliance door open for too long	Close appliance door
HI	Temperature inside appliance too high (too warm)	Check that the door has been closed properly. If the temperature does not drop, contact the customer service department.
LO	Temperature inside appliance too low (too cold)	Contact the customer service department
Etc		Reset the real time clock (see "Setting the real time clock")
HF, HA	There has been a power cut of some length or the interior was too warm or too cold during a certain period of time.	See <b>Calling up stored alarm events and reading the temperature progression</b>
btE	Back-up Battery error	Check if the battery is connected properly. See Back-up Battery. If the connection is correct and the error code is still displayed, contact the customer service department.
btP	Power failure alarm	It will go out again when mains voltage is applied. Make a decision on what you wish to do with the items stored in the appliance.

## Changing over door hinges

Door hinges should only be changed by a trained expert.  
Changing the door hinges must be done by two people.

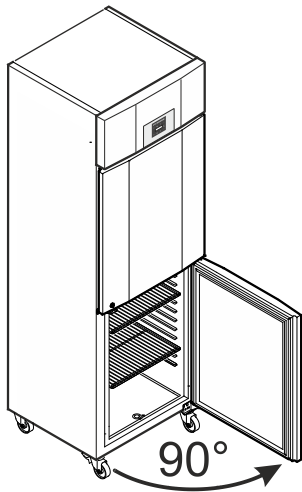

1. Open door by about 90°.

### Important note

The door must be opened 90° before the lower hinge bracket is removed.

This will hold the self-closing mechanism that is integrated into the door in the required position for installation.

### ⚠ WARNING!

If the door is removed and reinstalled in the closed position, this will lead to destruction of the self-closing mechanism on the first opening of the door.

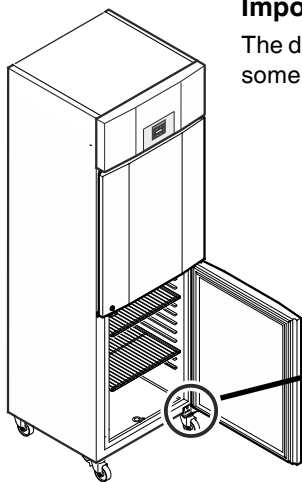

### Important

The door must now be held secure by somebody.

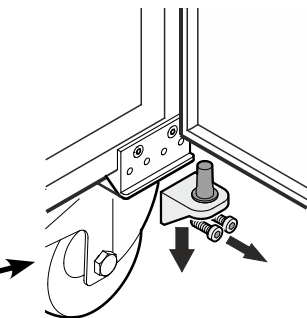

2. Remove hinge bracket.  
Pull the door out at the bottom and lift off.

3. Remove bearing ring from upper door mounting.

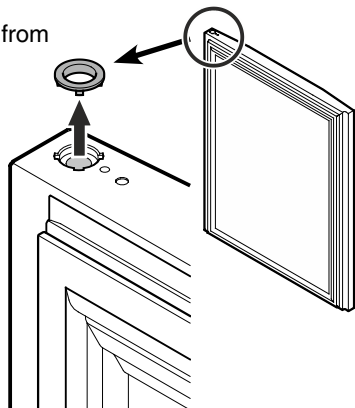

4. Remove the hinge components from the hinge bracket.

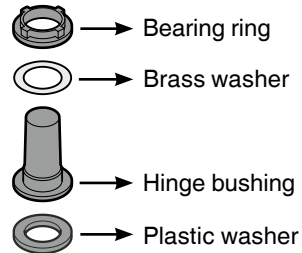

### Note on point 4

The hinge bushing with brass washer and bearing ring may stick in the door mounting when you pull out the hinge bracket and, in this case, must be removed from it.

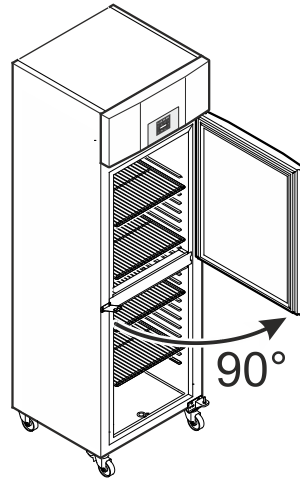

5. Open door by about 90°.

### Important note

The door must be opened 90° before the lower hinge bracket is removed.

This will hold the self-closing mechanism that is integrated into the door in the required position for installation.

### ⚠ WARNING!

If the door is removed and reinstalled in the closed position, this will lead to destruction of the self-closing mechanism on the first opening of the door.

### Important

The door must now be held secure by somebody.

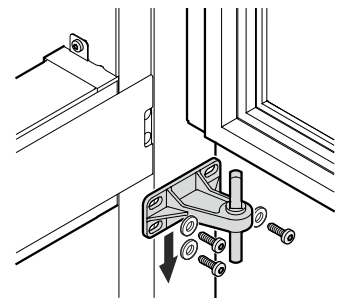
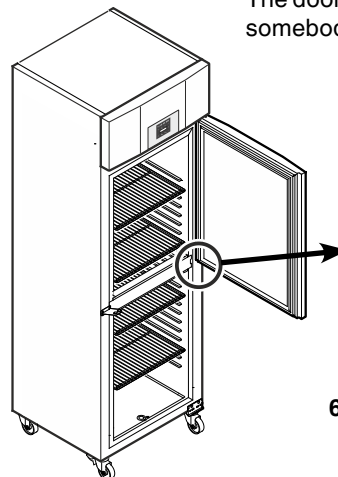

6. Remove hinge bracket.  
Pull the door out at the bottom and lift off.

7. Remove the hinge components from the hinge bracket.

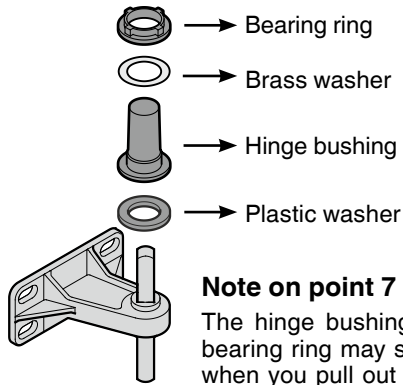

**Note on point 7**

The hinge bushing with brass washer and bearing ring may stick in the door mounting when you pull out the hinge bracket and, in this case, must be removed from it.

12. Fit the hinge components on the hinge bracket.

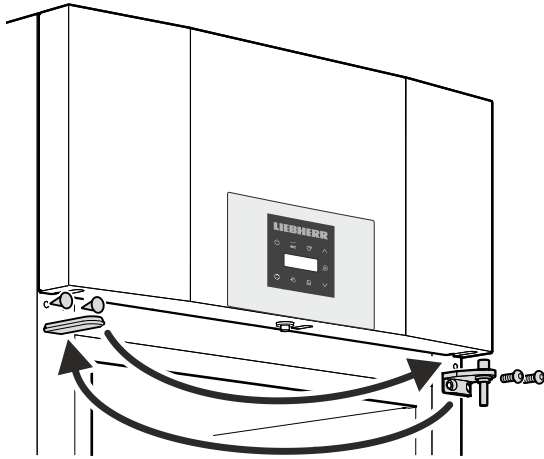
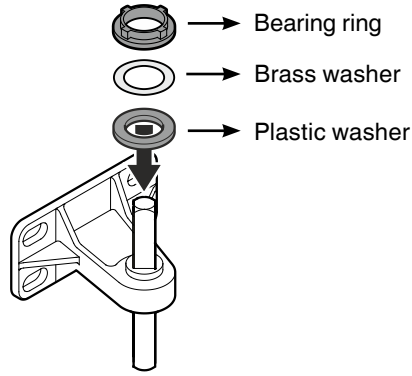

8. Transfer the upper hinge bracket and covers to the opposite side.

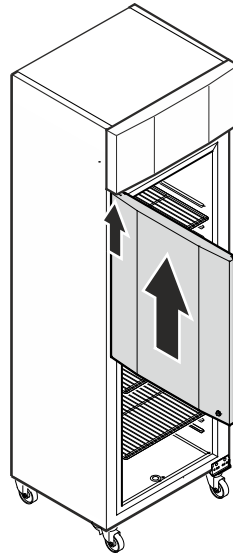

13. **Keeping door open at 90°**, suspend in top square pin.

**WARNING!**

It is essential that the door is open at an angle of 90° during installation.

If the door is installed in the closed position, this will lead to destruction of the self-closing mechanism on the first opening and closing of the door.

**Important**

The door must now be held secure by somebody.

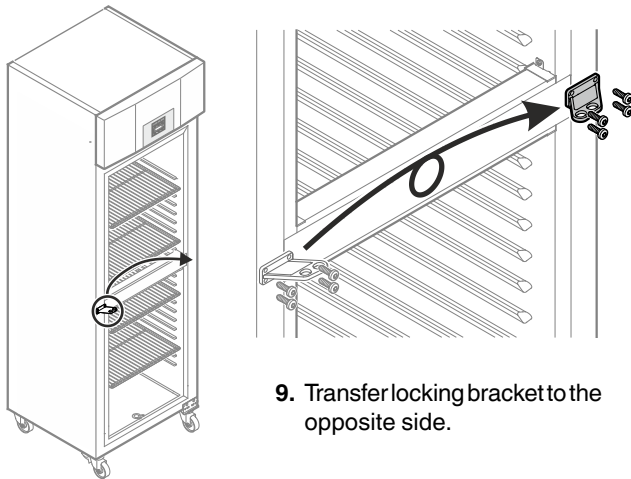

9. Transfer locking bracket to the opposite side.

14. Install the hinge bracket with the fitted hinge components in the lower door mounting.

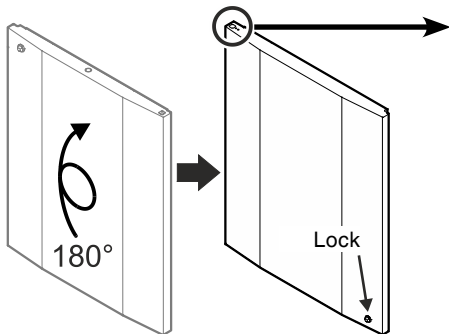
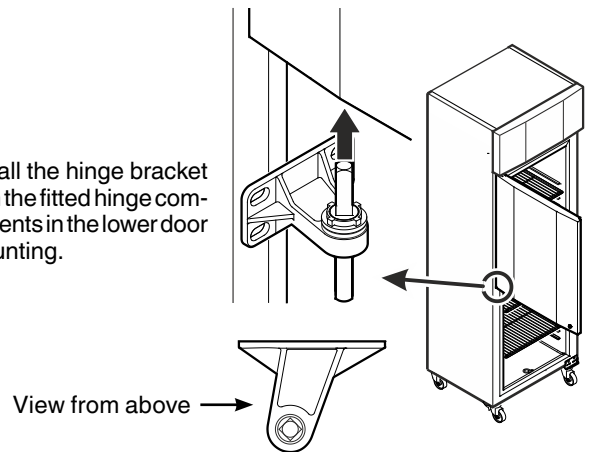

10. Turn the door by 180°.

11. Insert the bearing ring and hinge bushing in the upper door mounting.

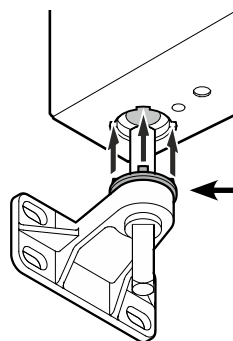

**Note on point 14**

The tabs on the bearing ring must fit into the recesses of the door mounting during installation.

If necessary, gently rotate the upper ring.

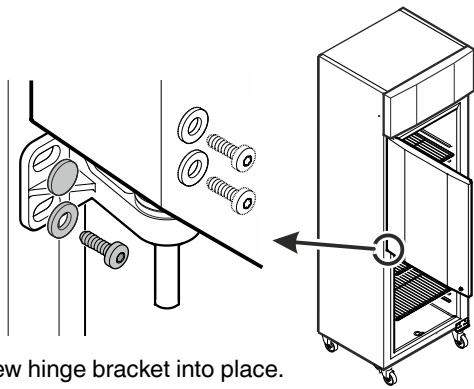

15. Screw hinge bracket into place.  
Close appliance door.

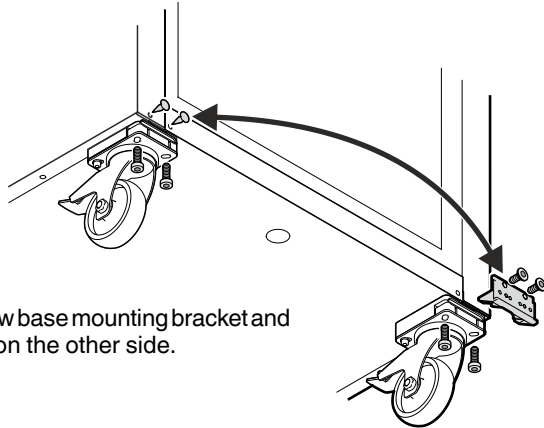

16. Unscrew base mounting bracket and attach on the other side.

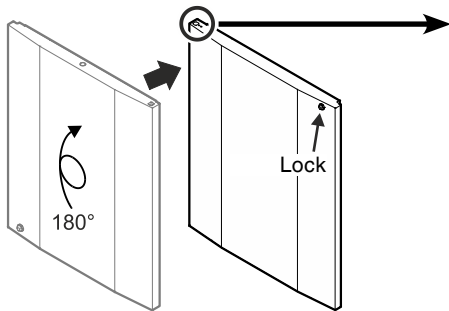

17. Turn the door by 180°.

18. Insert the bearing ring and hinge bushing in the upper door mounting.

19. Fit the hinge components on the hinge bracket.

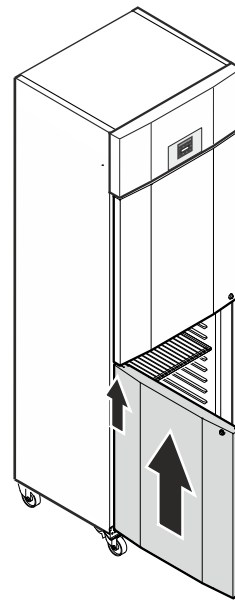
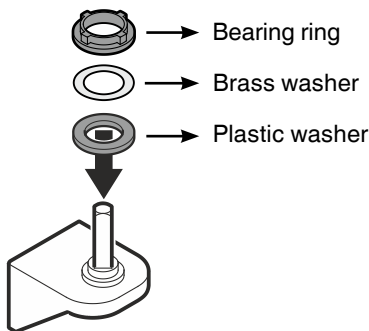

20. Keeping door open at 90°, suspend in square pin.

**⚠ WARNING!**

It is essential that the door is open at an angle of 90° during installation.

If the door is installed in the closed position, this will lead to destruction of the self-closing mechanism on the first opening and closing of the door.

**Important**

The door must now be held secure by somebody.

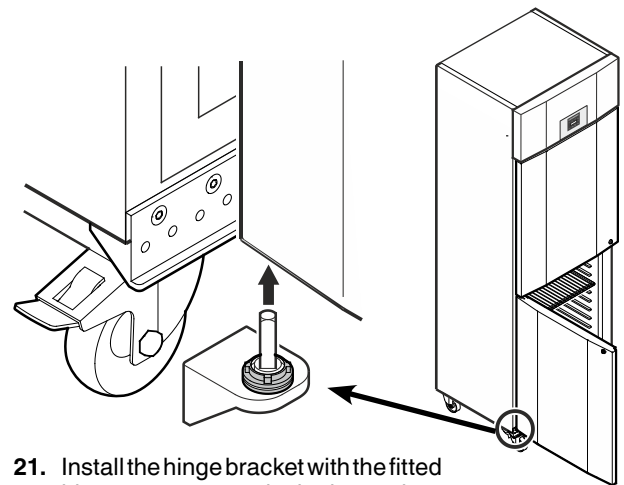

21. Install the hinge bracket with the fitted hinge components in the lower door mounting.

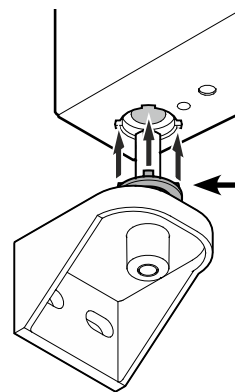

**Note on point 21**

The tabs on the bearing ring must fit into the recesses of the door mounting during installation.

If necessary, gently rotate the upper ring.

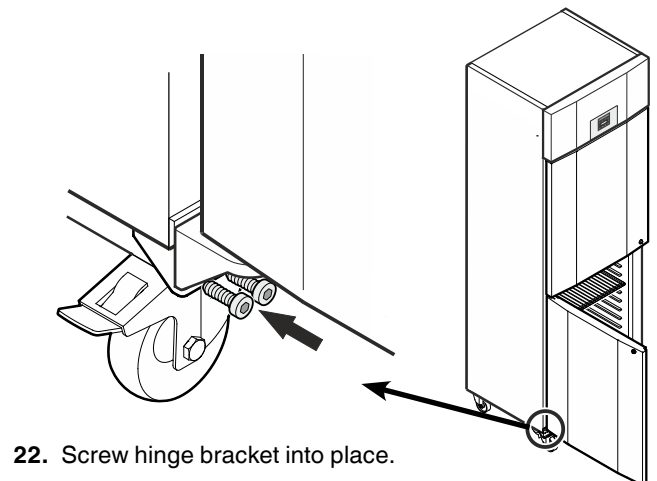

22. Screw hinge bracket into place.



**Liebherr-Hausgeräte GmbH**  
Memminger Straße 77-79  
88416 Ochsenhausen  
Germany  
[home.liebherr.com](http://home.liebherr.com)

