



**KERN & Sohn GmbH**

Ziegelei 1  
D-72336 Balingen  
E-Mail: [info@kern-sohn.com](mailto:info@kern-sohn.com)

Phone: +49-[0]7433- 9933-0  
Fax: +49-[0]7433-9933-149  
Internet: [www.kern-sohn.com](http://www.kern-sohn.com)

# Operating instructions Analytical balance

## KERN ADB

Version 1.0  
11/2015  
GB



ADB-BA-e-1510



# KERN ADB

Version 1.0 11/2015

## Operating instructions Analytical balance

### Contents

<b>1</b>	<b>Technical data</b> .....	<b>4</b>
1.1	Dimensions .....	5
<b>2</b>	<b>Appliance overview</b> .....	<b>6</b>
2.1	Keyboard overview.....	7
2.2	Overview of display.....	8
<b>3</b>	<b>Basic Information (General)</b> .....	<b>9</b>
3.1	Intended use .....	9
3.2	Improper Use .....	9
3.3	Warranty .....	9
3.4	Monitoring of Test Resources.....	10
<b>4</b>	<b>Basic Safety Precautions</b> .....	<b>10</b>
4.1	Pay attention to the instructions in the Operation Manual .....	10
4.2	Personnel training .....	10
<b>5</b>	<b>Transport and storage</b> .....	<b>10</b>
5.1	Testing upon acceptance .....	10
5.2	Packaging / return transport .....	11
<b>6</b>	<b>Unpacking, Setup and Commissioning</b> .....	<b>13</b>
6.1	Installation Site, Location of Use.....	13
6.2	Unpacking, checking and installation .....	13
6.3	Levelling .....	14
6.4	Electric power supply .....	15
6.5	Initial Commissioning .....	15
6.6	Connection of peripheral devices.....	15
<b>7</b>	<b>Adjustment</b> .....	<b>16</b>
7.1	Adjustment with recommended adjustment weight .....	16
7.1.1	Adjustment with 100 g-weight .....	17
<b>8</b>	<b>Basic Operation</b> .....	<b>18</b>
8.1	Start-up.....	18
8.2	Switch into stand-by mode.....	18
<b>9</b>	<b>Applications</b> .....	<b>21</b>
<b>10</b>	<b>Menu</b> .....	<b>24</b>
10.1	Navigation in the menu .....	24
10.2	Menu overview.....	26
10.3	Description of individual functions .....	27
10.3.1	Automatic zero point correction.....	27

- 11 RS232C-interface ..... 28**
- 11.1 **Technical data..... 28**
- 11.2 **Interface cable: ..... 29**
- 11.3 **Interface parameters ..... 29**
- 11.3.1 Baud rate ..... 29
- 11.3.2 Output condition ..... 30
- 11.4 **Sample protocols (KERN YKB-01N) ..... 31**
- 12 Servicing, maintenance, disposal ..... 32**
- 13 Instant help..... 33**

## 1 Technical data

KERN	ADB 200-4
Readability (d)	0.1 mg
Weighing range (max)	210 g
Reproducibility	0.2 mg
Linearity	± 0.4 mg
Recommended adjusting weight not supplied (class)	200 g (E2)
Stabilization time	3 sec.
Warm-up time	8 h
Weighing Units	g, oz, ct, lb
Smallest part weight for piece counting	0.1 mg
Reference quantities at piece counting	5, 10, 20, 50,100
Weighing plate, stainless steel	ø 90 mm
Net weight (kg)	6
Permissible ambient condition	+10° C to +30° C
Humidity of air	20 ~ 85 % relative (not condensing)
Power supply unit Input voltage	AC 110 -230 V, 50-60Hz
Balance Input voltage	DC 12 V, 4 A
Interface	RS232C

1.1 Dimensions

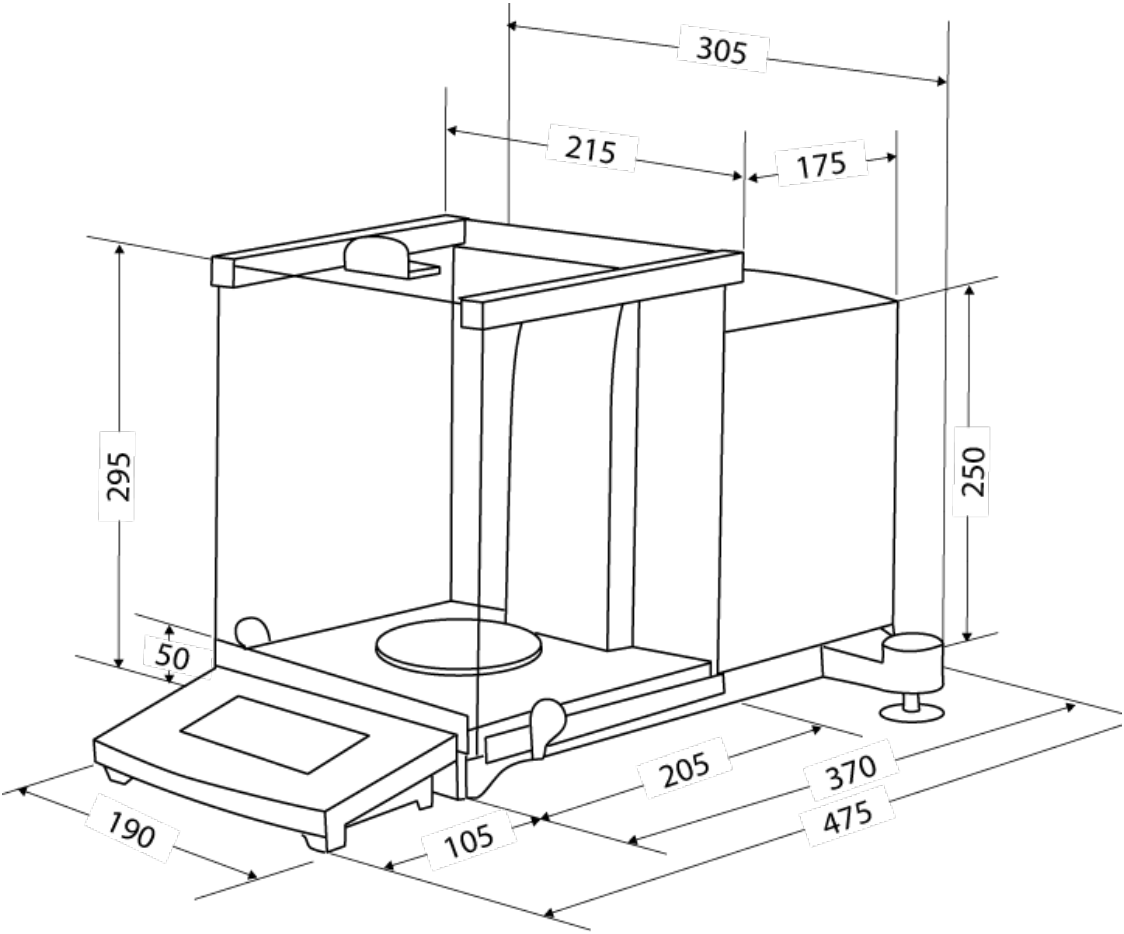

## 2 Appliance overview

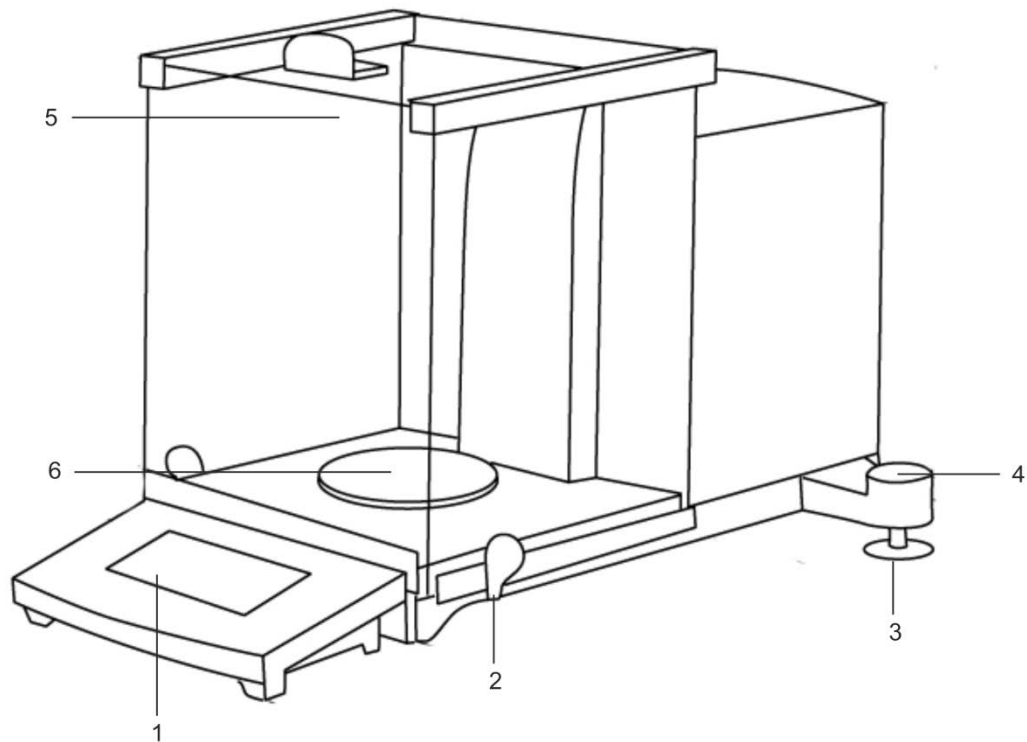



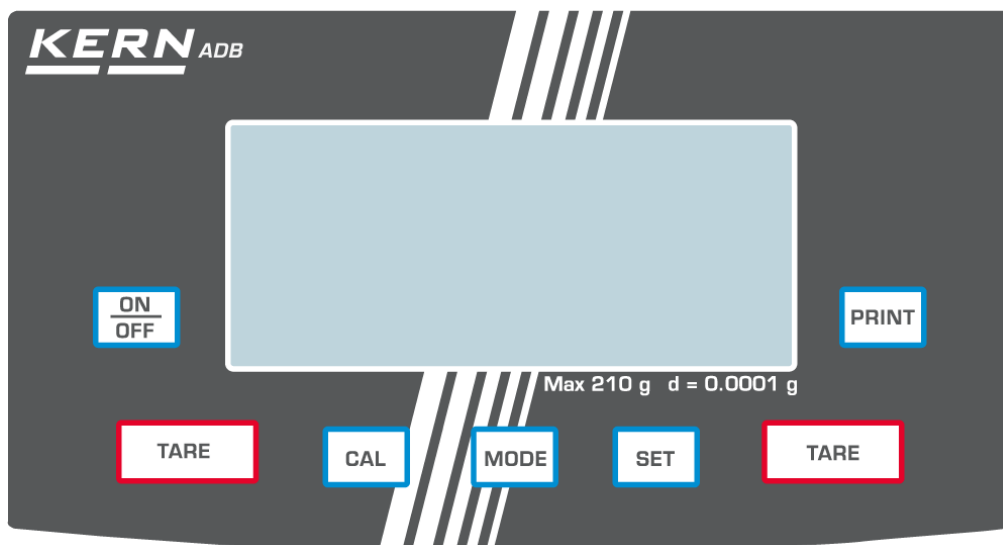

Pos.	Designation
------	-------------

- |   |   |
|---|---|
| 1 | Display   |
| 2 | Handle for operation of the side windshield doors |
| 3 | Foot screws                                       |
| 4 | Bubble level                                      |
| 5 | Windshield  |
| 6 | Weighing pan                                      |

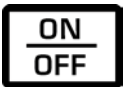
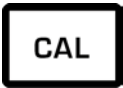
## 2.1 Keyboard overview



Button	Function
	<ul style="list-style-type: none"> <li>➤ Turn on/off</li> <li>➤ Exit menu</li> </ul>
	<ul style="list-style-type: none"> <li>➤ Adjustment</li> </ul>
	<ul style="list-style-type: none"> <li>➤ Taring</li> <li>➤ Zeroing</li> <li>➤ Save setting</li> </ul>
	<ul style="list-style-type: none"> <li>➤ Switch-over weighing unit</li> <li>➤ Selecting an application</li> </ul>
	<ul style="list-style-type: none"> <li>➤ How to save the reference</li> <li>➤ Switch on/off background illumination of display (keep pressed the buttons long time)</li> </ul>
	<ul style="list-style-type: none"> <li>➤ Change setting in the menu</li> <li>➤ Print out the displayed value</li> </ul>

## 2.2 Overview of display

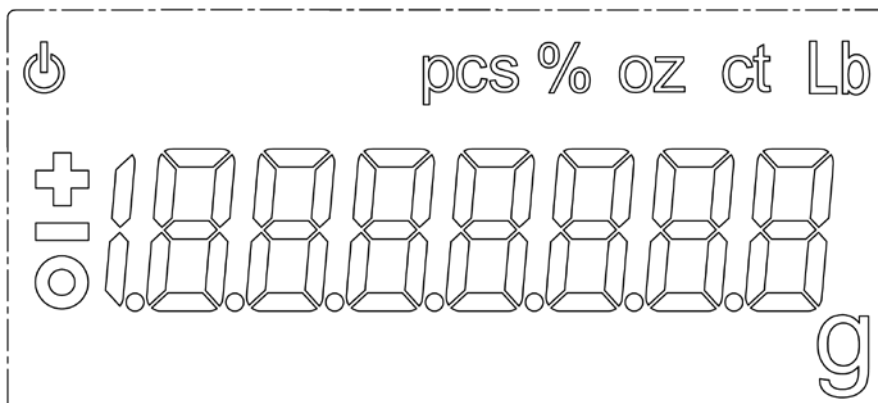

Display	Description
○	Display of stable values
⏻	The balance is in stand-by mode
<b>g</b>	Weighing unit "Gram"
<b>ct</b>	Weighing unit „Carat“
<b>lb</b>	Weighing unit „Pound“
<b>oz</b>	Weighing unit „Ounce“
<b>Pcs</b>	Application parts counting
<b>%</b>	Application percentage determination



## 3 Basic Information (General)

### 3.1 Intended use

The balance you purchased is intended to determine the weighing value of material to be weighed. It is intended to be used as a “non-automatic balance”, i.e. the material to be weighed is manually and carefully placed in the centre of the weighing pan. As soon as a stable weighing value is reached the weighing value can be read.

### 3.2 Improper Use

Do not use balance for dynamic add-on weighing procedures, if small amounts of goods to be weighed are removed or added. The “stability compensation“ installed in the balance may result in displaying an incorrect measuring value! (Example: Slowly draining fluids from a container on the balance.)

Do not leave permanent load on the weighing pan. This may damage the measuring system.

Impacts and overloading exceeding the stated maximum load (max) of the balance, minus a possibly existing tare load, must be strictly avoided. Balance may be damaged by this.

Never operate balance in explosive environment. The serial version is not explosion protected.

The structure of the balance may not be modified. This may lead to incorrect weighing results, safety-related faults and destruction of the balance.

The balance may only be used according to the described conditions. Other areas of use must be released by KERN in writing.

### 3.3 Warranty

Warranty claims shall be voided in case

- Our conditions in the operation manual are ignored
- The appliance is used outside the described uses
- The appliance is modified or opened
- Mechanical damage or damage by media, liquids, natural wear and tear
- The appliance is improperly set up or incorrectly electrically connected
- The measuring system is overloaded

### 3.4 Monitoring of Test Resources

In the framework of quality assurance the measuring-related properties of the balance and, if applicable, the testing weight, must be checked regularly. The responsible user must define a suitable interval as well as type and scope of this test. Information is available on KERN's home page ([www.kern-sohn.com](http://www.kern-sohn.com)) with regard to the monitoring of balance test substances and the test weights required for this. In KERN's accredited DKD calibration laboratory test weights and balances may be calibrated (return to the national standard) fast and at moderate cost.

## 4 Basic Safety Precautions

### 4.1 Pay attention to the instructions in the Operation Manual



Carefully read this operation manual before setup and commissioning, even if you are already familiar with KERN balances.

### 4.2 Personnel training

The appliance may only be operated and maintained by trained personnel.

## 5 Transport and storage

### 5.1 Testing upon acceptance

When receiving the appliance, please check packaging immediately, and the appliance itself when unpacking for possible visible damage.

## 5.2 Packaging / return transport



- ⇒ Keep all parts of the original packaging for a possibly required return.
- ⇒ Only use original packaging for returning.
- ⇒ Prior to dispatch disconnect all cables and remove loose/mobile parts.
- ⇒ Pack display unit, weighing plate + accessories and power supply unit separately.
- ⇒ Secure glass windshield against slipping (e.g. using an adhesive strip).



- ⇒ Reattach possibly supplied transport securing devices.
- ⇒ Secure all parts against shifting and damage as depicted.



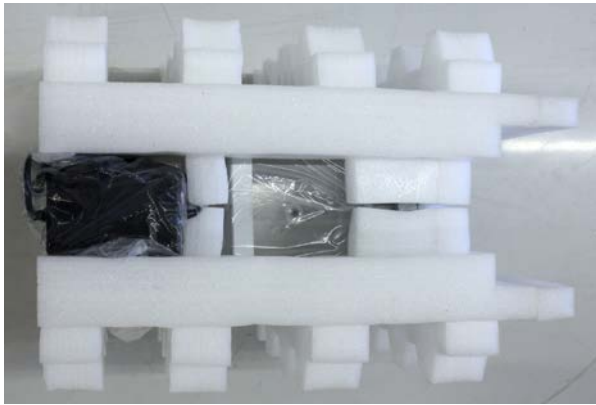

## 6 Unpacking, Setup and Commissioning

### 6.1 Installation Site, Location of Use

The balances are designed in a way that reliable weighing results are achieved in common conditions of use.

You will work accurately and fast, if you select the right location for your balance.

**On the installation site observe the following:**

- Place the balance on a firm, level surface;
- Avoid extreme heat as well as temperature fluctuation caused by installing next to a radiator or in the direct sunlight;
- Protect the balance against direct draughts due to open windows and doors;
- Avoid jarring during weighing;
- Protect the balance against high humidity, vapours and dust;
- Do not expose the device to extreme dampness for longer periods of time. Non-permitted condensation (condensation of air humidity on the appliance) may occur if a cold appliance is taken to a considerably warmer environment. In this case, acclimatize the disconnected appliance for ca. 2 hours at room temperature.
- Avoid static charge of goods to be weighed or weighing container.

If electro-magnetic fields or static charge occur, or if the power supply is unstable major deviations on the display (incorrect weighing results) are possible. In that case, the location must be changed.

### 6.2 Unpacking, checking and installation

Open packaging and remove all parts carefully.

Verify that there has been no damage and that all packing items are present.

#### Scope of delivery / serial accessories

1. Balance
2. Display Unit
3. Weighing pan
4. Carrier weighing plate
5. Air chamber
6. Bottom sheet (round)
7. Mains adapter
8. Country-specific mains plug
9. Operating instructions



Prior to any installation and assembly works, the balance must be separated from the mains supply.

- ⇒ Remove the transport securing from the lower side of the balance.



- ⇒ Install the balance at the intended workplace.  
The right place is decisive for the accuracy of the weighing results of high-resolution analytic balances (see chap. 6.1).
- ⇒ Put the following parts upon in the right order
- Round bottom sheet
  - Air chamber
  - Carrier of weighing plate
  - Weighing pan
- ⇒ Connect the display unit with the balance.  
As the terminal is not rigidly assembled to the balance, it can be freely placed in the vicinity of the balance but not further away than this is permitted by the length of the cable.

### 6.3 Levelling

- ⇒ Level balance with foot screws until the air bubble of the water balance is in the prescribed circle.

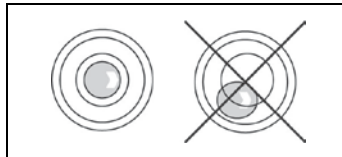

- i** Check levelling regularly.

## 6.4 Electric power supply



Select a country-specific mains plug and plug it into the mains adapter.



Check, whether the voltage acceptance on the scales is set correctly. Do not connect the scales to the power grid unless the information on the instrument (sticker) matches the local mains voltage.

Only use KERN original mains adapter. Using other makes requires consent by KERN.



### **Important:**

- Prior to commissioning check the mains cable for damage.
- Make sure that the mains adapter will not be in touch with liquids.
- The mains plug must be accessible at any time.

Connect the mains adapter to the connecting socket on the backside of the balance and to the power mains. The display unit lights up. As soon as the balance is supplied with energy, the indicator [  ] is displayed.



## 6.5 Initial Commissioning

In order to obtain exact results with the electronic balances, your balance must have reached the operating temperature (see warming up time chap. 1). During this warming up time the balance must be connected to the power supply (mains, accumulator or battery).

The accuracy of the balance depends on the local acceleration of gravity. Strictly observe hints in chapter Adjustment.

## 6.6 Connection of peripheral devices

Before connecting or disconnecting of additional devices (printer, PC) to the data interface, always disconnect the balance from the power supply.

With your balance, only use accessories and peripheral devices by KERN, as they are ideally tuned to your balance.

## 7 Adjustment

As the acceleration value due to gravity is not the same at every location on earth, each balance must be coordinated - in compliance with the underlying physical weighing principle - to the existing acceleration due to gravity at its place of location (only if the balance has not already been adjusted to the location in the factory).

This adjustment process must be carried out for the first commissioning, after each change of location as well as in case of fluctuating environment temperature.

To receive accurate measuring values it is also recommended to adjust the balance periodically in weighing operation.

Observe stable environmental conditions. A warming up time (see chapter 1) is required for stabilization. Ensure that there are no objects on the weighing pan.

- i**
- Carry out adjustment as near as possible to the balance's maximum weight (required adjustment weight see chap. 1). Info about adjustment weights can be found on the Internet at: <http://www.kern-sohn.com>
  - Observe stable environmental conditions. Stabilisation requires a certain warm-up time.
  - Ensure that there are no objects on the weighing pan.

### 7.1 Adjustment with recommended adjustment weight

We recommend to carry out all adjustments as close as possible to the maximum load of the balance.



Press the **CAL** button until „CAL 100“ will be displayed.

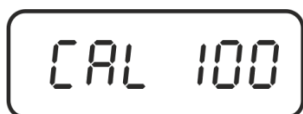

Press **TARE** key to select „CAL 200“

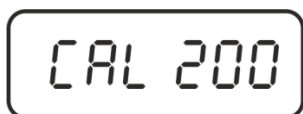

Put the required adjustment weight (200 g) carefully in the centre of the weighing plate and close the windshield doors.





Press the **CAL** key

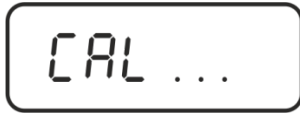

After successful adjustment the balance automatically returns to weighing mode.

Take away adjustment weight.

### 7.1.1 Adjustment with 100 g-weight

Adjustment is also possible with a weight of 100 g, but is not optimal for technical measuring.



Press the **CAL** key until „CAL 100“ will be displayed.

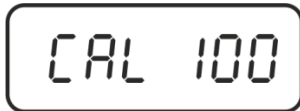

Put the adjustment weight (100 g) carefully in the centre of the weighing plate and close the windshield doors.



Press the **CAL** key

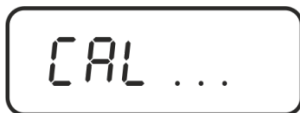

After successful adjustment the balance automatically returns to weighing mode.

Take away adjustment weight.

## 8 Basic Operation

### 8.1 Start-up



As soon as the balance is supplied with energy, the indicator [⏻] is displayed.



To switch on press the **ON/OFF** key.



The balance carries out a display test.

As soon as the weight display appears, the balance is ready for weighing.

### 8.2 Switch into stand-by mode



Press **ON/OFF** key, the display disappears



The power symbol [⏻] will be displayed.



- In stand-by mode the balance is ready for operation immediately after switching-on without warm-up time.
- To switch off the balance completely, separate it from the mains.
- The balance starts in the mode, in which it has been switched off.

### 8.3 Zeroing

In order to obtain optimal weighing results, reset to zero the balance before weighing.



Unload the balance.  
Press the **TARE** key.



Wait until the zero display appears.

### 8.4 Simple weighing



Place the goods to be weighed and close the windshield.

Wait for stability display .  
Read weighing result.



➤ **Overload warning**

Overloading exceeding the stated maximum load (max) of the device, minus a possibly existing tare load, must be strictly avoided. This could damage the instrument.

Exceeding the maximum load is indicated by the display „Err“. Unload weighing system or reduce preload.

### 8.5 Unity change

By repeated pressing of the **MODE** key the weighed value can be switched over to the available weighing and application units.

g ⇔ oz ⇔ ct ⇔ lb ⇔ Pcs ⇔ %

## 8.6 Weighing with tare

The dead weight of any weighing container may be tared away by pressing a button, so that the following weighing procedures show the net weight of the goods to be weighed.



Set balance to zero

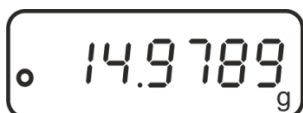

Deposit empty weighing container. The result is displayed.



Wait for stability display, then press the **TARE** key



The zero display appears.



Weigh the material, the net weight will be indicated.



- When the balance is unloaded the saved taring value is displayed with negative sign.
- To delete the stored tare value, remove load from weighing pan and press the **TARE** key.

## 9 Applications

### 9.1 Parts counting

Before the balance can count parts, it must know the average part weight (i.e. the reference). Proceed by putting on a certain number of the parts to be counted. The balance determines the total weight and divides it by the number of parts, the so-called reference quantity. Counting is then carried out on the basis of the calculated average piece weight.

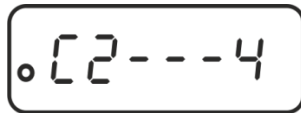
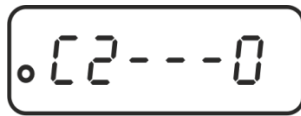

#### 1. Select the reference piece number

In weighing mode call up menu item „C2“, see chap. 10.1

Select the desired reference number of pieces using the **PRINT** key, see chap. 10.2.

Confirm setting by pressing the **TARE** key.

Exit menu using **ON/OFF** key: Confirm query „SAVE“ by pressing the **TARE** key.

The balance returns automatically into weighing mode

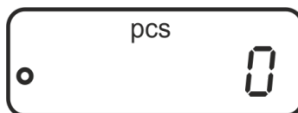

#### 2. Call application

Press the **MODE** key repeatedly until „Pcs“ is displayed.

#### 3. Set to zero/taring

Press the **TARE** key to set the balance to zero or to tare when using a weighing container.

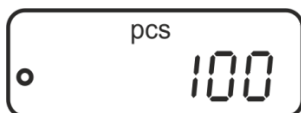
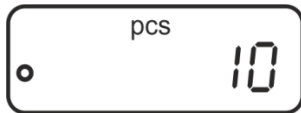

#### Sample protocol (KERN YKB-01N)

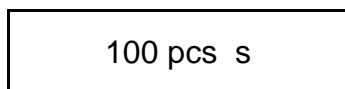

#### 4. Weigh-in reference parts

Place as many counted pieces to add-up as required by the set reference piece number.

Press the **SET** key to save the reference whereupon the weighing scale automatically calculates an average weight per part.

Remove reference weight. The balance is now in parts counting mode and counts all units on the weighing plate.

#### 5. Count the items

Place load on pan and read the number of pieces.

#### 6. Switch-over display between number of items and weight

Use the **MODE** key to switch-over the display to the available units, see chap. 8.5

#### 7. Printing

The display value will be printed out by connecting an optional printer and pressing the **PRINT** key (factory setting).



- Take care of the minimum weight of the piece (see chap. 1 „Technical data“).
- The reference weight will remain stored even after the weighing balance was turned off until the reference is reset.

## 9.2 Percent determination

Percentage calculation facilitates weight display in percent related to a reference weight equivalent to 100 %.

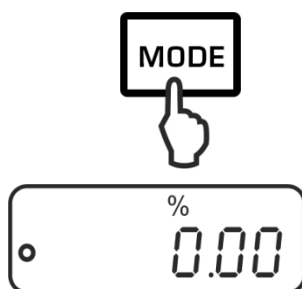

### 1. Call application

Press the **MODE** key several times until „%“ is displayed.

### 2. Set to zero/taring

Press the **TARE** key to set the balance to zero or to tare when using a weighing container.



### 3. Reference setting (100 % value)

Put a reference weight which corresponds to 100 %. Store reference by pressing the **SET** key.

Remove reference weight.

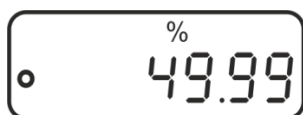

### 4. Percent determination

Place goods to be weighed on balance. The weight of the sample is displayed in percentage in terms of the reference weight.



### 5. Switch-over the display between percentage and weight

Use the **MODE** key to switch-over the display to the available units, see chap. 8.5

### Sample protocol (KERN YKB-01N)

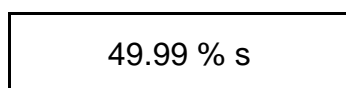

### 6. Printing

The display value will be printed out by connecting an optional printer and pressing the **PRINT** key (factory setting).

**i** The reference weight (100 %) will remain stored even after the weighing balance was turned off until the reference is reset.

## 10 Menu

### 10.1 Navigation in the menu

#### 1. Access to menu

⇒ In weighing mode print first the **SET** key, then the **PRINT** key. The first menu item „C1“ showing the current setting will be displayed.

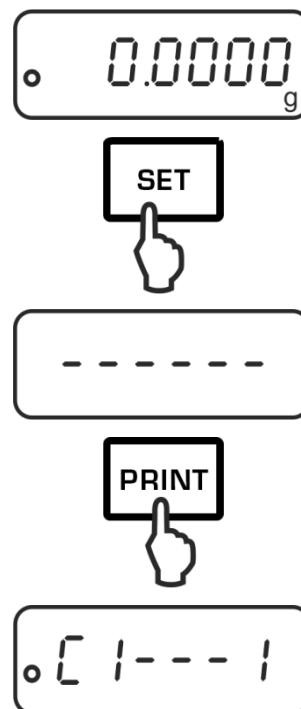

#### 2. Select menu items

⇒ Press the **TARE** key to select the individual menu items showing the current settings one by one.

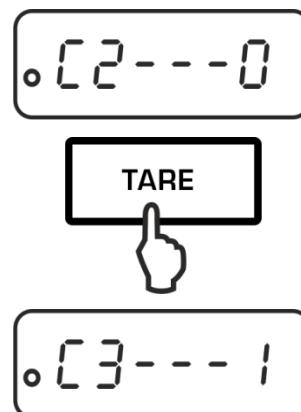

#### 3. Change settings

⇒ Press the **PRINT** key to change the setting of a selected menu item. Each time the **PRINT** key is pressed the next setting will be displayed.

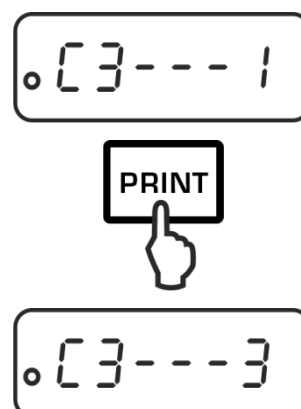



- ⇒ Confirm setting with **TARE** key, the next menu item will be displayed.  
Either carry out more settings or exit and save menu (see step 4 or 5)

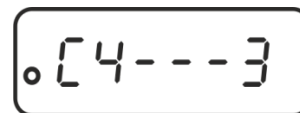

#### 4. How to save settings and to exit the menu

- ⇒ Press the **ON/OFF** key, „SAVE“ will be displayed.



- ⇒ Any changes carried out are stored by pressing the **TARE** key. The balance returns automatically into weighing mode.

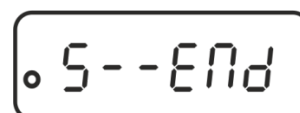

#### 5. Cancel

- ⇒ Press again the **ON/OFF** key, no changes will be saved. The balance returns automatically into weighing mode.

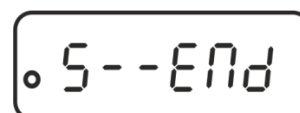
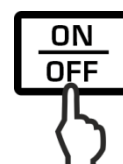

## 10.2 Menu overview

Menu item	Settings	Description
Adjustment mode	C1 - 0	Not documented
	C1 - 1*	Always use this setting
Reference quantity	C2 - 0	10
	C2 - 1	20
	C2 - 2	50
	C2 - 3	100
	C2 - 4	1000
Automatic zero point correction	C3 - 0	Automatic zero tracking off
	C3 - 1	Automatic zero point correction ON <1d>
	C3 - 2	Automatic zero point correction ON <21d>
	C3 - 3	Automatic zero point correction ON <3d>
	C3 - 4	Automatic zero point correction ON <4d>
	C3 - 5	Automatic zero point correction ON <5d>
	C3 - 6	Not documented
Baud rate	C4 - 0	2400
	C4 - 1	1200
	C4 - 2	4800
	C4 - 3	9600
Data output	C5 - 0	Automatic output of stable weighing values
	C5 - 1	Via remote control command (P)
	C5 - 2	Continuous data output of stable and instable weighing values (interval 3 s)
	C5 - 3	Output for stable and instable weighing values after pressing <b>PRINT</b> key
Sound by pressing the button	C6 - 0	switched on
	C6 - 1*	switched off
Not documented	C7 - 0*	Always use this setting
	C7 - 1	Not documented

## 10.3 Description of individual functions

### 10.3.1 Automatic zero point correction

This function is used to tare small variations in weight automatically.

In the event that small quantities are removed or added to the material to be weighed, incorrect weighing results can be displayed due to the “stability compensation“. (e.g. slow flow of liquids from a container placed on the balance, evaporating processes).

When apportioning involves small variations of weight, it is advisable to switch off this function.

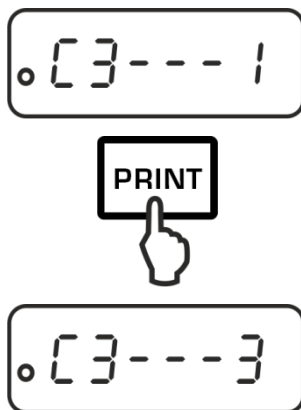

Call up menu item „C3“, see chap. 10.1

Select the desired setting using the **PRINT** key, see chap. 10.2.

Save / back to weighing mode, see chap. 10.1

## 11 RS232C-interface

For the connection of a peripheral device (printer, computer) the balance is as per series equipped with a RS232C-interface.

The following conditions must be met to provide successful communication between the weighing balance and the peripheral devices.

- Connect balance using a suitable cable with the interface of the peripheral device. Faultless operation requires an adequate KERN interface cable.
- Communication parameters (baud rate, bits and parity) of balance and peripheral device must match.

This data exchange is asynchronous using ASCII - Code.

### 11.1 Technical data

Connection 9 pin d-subminiature bushing

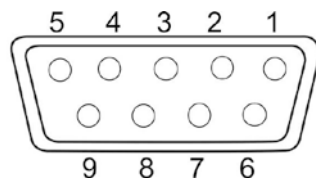

Pin 2: Receive data  
Pin 3: Transmit data  
Pin 5: Signal ground

Baud rate 1200 / 2400 / 4800 / 9600 optional

Parity 8 bits, no parity / 1 stop bit / 1 start bit

## 11.2 Interface cable:

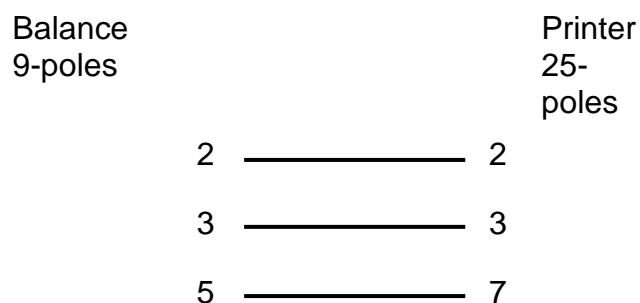
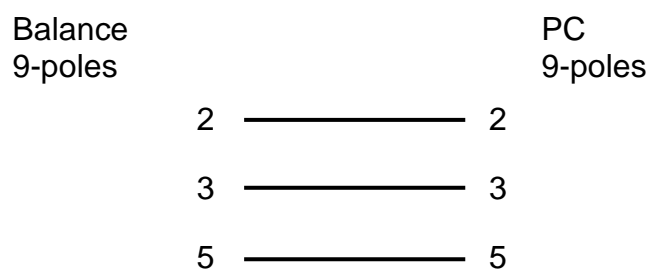

## 11.3 Interface parameters

### 11.3.1 Baud rate

In this menu point the data transfer is adapted to different RS232C-peripheral devices. The baud rate determines the speed of the data transfer via the serial interface. For a faultless data transfer, balance and peripheral device must be set to the same value.

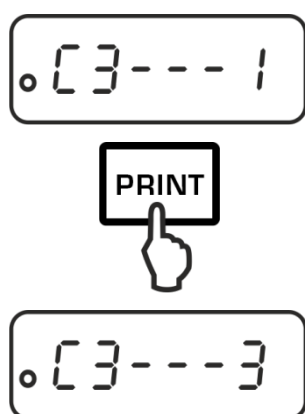

Call up menu item „C3“, see chap. 10.1

Use the **PRINT** key to select the desired setting.

Options:

**C4 - 0** 2400 baud

**C4 - 1** 1200 Baud

**C4 - 2** 4800 baud

**C4 - 3** 9600 baud

Save / back to weighing mode, see chap. 10.1

### 11.3.2 Output condition

The data transfer type is determined in this menu item

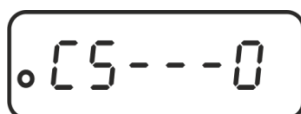
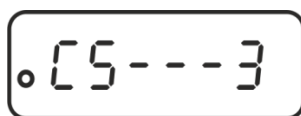

Call up menu item „C5“, see chap. 10.1

Use the **PRINT** key to select the desired setting.

Options:

- C5 - 0** Automatic edition of stable weighing values
- C5 - 1** Via remote control command (P)
- C5 - 2** Continuous data output of stable and instable weighing values (interval 3 s)
- C5 - 3** Output for stable and instable weighing values after pressing **PRINT** key

Save / back to weighing mode, see chap. 10.1

## 11.4 Sample protocols (KERN YKB-01N)

+ 10.0000 g s	Stable/positive weighing value
- 10.0000 g us	Instable/negative weighing value
100 pcs s	Parts counting (stable weighing value)
49.99 % s	Percentage determination (stable weighing value)

## 11.5 Remote control instructions

Command		Terminator		Function
ASCII	Hex	<CR>	<LF>	
O	4F	0D	0A	Function such as <b>ON/OFF</b> key
T	54	0D	0A	Function such as <b>TARE</b> key
C	43	0D	0A	Function such as <b>CAL</b> key
M	4D	0D	0A	Function such as <b>MODE</b> key
P	50	0D	0A	Function such as <b>PRINT</b> key

## 12 Servicing, maintenance, disposal



Before any maintenance, cleaning and repair work disconnect the appliance from the operating voltage.

### 12.1 Cleaning

Please do not use aggressive cleaning agents (solvents or similar agents), but a cloth dampened with mild soap suds. Ensure that no liquid penetrates into the device. Polish with a dry soft cloth.

Loose residue sample/powder can be removed carefully with a brush or manual vacuum cleaner.

**Spilled weighing goods must be removed immediately.**

### 12.2 Servicing, maintenance

⇒ The appliance may only be opened by trained service technicians who are authorized by KERN.

⇒ Before opening, disconnect from power supply.

### 12.3 Disposal

Disposal of packaging and appliance must be carried out by operator according to valid national or regional law of the location where the appliance is used.



## 13 Instant help

In case of an error in the program process, briefly turn off the balance and disconnect from power supply. The weighing process must then be restarted from the beginning.

Help:

### Fault

### Possible cause

The displayed weight does not glow.

- The balance is not switched on.
- The mains supply connection has been interrupted (mains cable not plugged in/faulty).
- Power supply interrupted.

The displayed weight is permanently changing

- Draught/air movement
- Table/floor vibrations
- Weighing pan has contact with other objects.
- Electromagnetic fields / static charging (choose different location/switch off interfering device if possible)

The weighing result is obviously incorrect

- The display of the balance is not at zero
- Adjustment is no longer correct.
- The balance is on an uneven surface.
- Great fluctuations in temperature.
- Warm-up time was ignored.
- Electromagnetic fields / static charging (choose different location/switch off interfering device if possible)