

# 87R-4P Compressed Air System

Installation/User Guide

## Operation & Maintenance Manual



# JUN-AIR®

<b>Section</b>	<b>Page Number</b>
Declaration of Conformity	3
Operating Manual	4
Technical Data & Specifications	14
Maintenance	15
Parts and Accessories	19



### Declaration of Conformity

Konformitätsbescheinigung  
 Certificat de Conformité  
 Declaración de Conformidad  
 Conformiteitsverklaring  
 Overensstemmelseserklæring

**GB** The manufacturer Gast Manufacturing, Inc. declares that the compressor is in conformity with:

- 2009/105/EC Council Directive relating to Simple Pressure Vessels
- 2006/42/EC Machinery Directive
- 2004/108/EC EMC Directive
- 2006/95/EC Low Voltage Directive
- 2011/65/EU RoHS 2 Directive
- 2012/19/EU WEEE Directive
- 1907/2006 and 340/2008 REACH Regulation

**DE** Der Hersteller Gast Manufacturing, Inc. bescheinigt, dass der Kompressor entspricht:

- 2009/105/EC Richtlinie der einfachen Druckbehälter
- 2006/42/EC Richtlinie zur Sicherheit von Maschinen
- 2004/108/EC Richtlinie der Elektromagnetischen Verträglichkeit
- 2006/95/EC Richtlinie für Niederspannung
- 2011/65/EU RoHS Directive
- 2012/19/EU WEEE Directive
- 1907/2006 and 340/2008 REACH Regulativ

**FR** Le fabricant Gast Manufacturing, Inc. déclare que le compresseur est conforme aux directives suivantes:

- 2009/105/EC Directive relative aux appareils à pression simple
- 2006/42/EC Directive sur la sécurité des machines
- 2004/108/EC Directive sur la compatibilité électro-magnétique
- 2006/95/EC Directive sur les basses-tensions
- 2011/65/EU Directive RoHS
- 2012/19/EU Directive DEEE
- 1907/2006 et 340/2008 Réglementation REACH

**ES** El fabricante Gast Manufacturing, Inc. declara que el compresor está conforme con:

- 2009/105/EC Directiva en relación a recipientes a presión simple
- 2006/42/EC Directiva de Seguridad de maquinaria
- 2004/108/EC Directiva de Compatibilidad eléctrica magnética
- 2006/95/EC Directiva de baja tensión
- 2011/65/EU Directiva de RoHS
- 2012/19/EU Directiva de WEEE
- 1907/2006 and 340/2008 Reglamento REACH

**NL** De fabrikant Gast Manufacturing, Inc. verklaart dat de compressor in overeenstemming is met:

- 2009/105/EC Richtlijn voor eenvoudige drukvaten
- 2006/42/EC Machinerichtlijn
- 2004/108/EC Richtlijn inzake Electromagnetische Compatibiliteit
- 2006/95/EC Laagspanningsrichtlijn
- 2011/65/EU RoHS Richtlijn
- 2012/19/EU WEEE Richtlijn
- 1907/2006 and 340/2008 REACH Verordening

**DK** Producenten Gast Manufacturing, Inc. bekræfter hermed at kompressoren er i overensstemmelse med:

- 2009/105/EC Direktivet vedrørende simple trykbeholdere
- 2006/42/EC Maskindirektivet
- 2004/108/EC EMC-direktivet
- 2006/95/EC Lavspændingsdirektivet
- 2011/65/EU RoHS Direktivet
- 2012/19/EU WEEE Direktivet
- 1907/2006 and 340/2008 REACH Forordningen

**IMPORTANT SAFETY INSTRUCTIONS AND REGULATORY INFORMATION****WARNING**

PLEASE READ THIS MANUAL COMPLETELY BEFORE INSTALLING AND USING THIS PRODUCT. SAVE THIS MANUAL FOR FUTURE REFERENCE AND KEEP IN THE VICINITY OF THE PRODUCT.

Dear Customer:

Congratulations on the purchase of your new JUN-AIR Industrial Compressed Air System.

This system's intended purpose is for industrial and laboratory compression applications. It is to be used in accordance with UL1450/CSA 22.2 standards, along with all applicable codes. The system utilizes an oil-less rocking piston compressor that produces clean, dry, oil-free pressurized air flow when connected to an industrial or laboratory device. The tank ensures that a constant supply of air is available to the device.

A pressure regulator and safety relief valve are also included to ensure safe operation of the system. This manual provides installation, operation and preventative maintenance guidelines that should be followed to ensure correct/reliable performance of this system.

Please complete the warranty card and return to JUN-AIR for registration. Please carry out all maintenance according to relevant instructions.

TABLE OF SYMBOLS

 **DANGER:** Indicates an imminently hazardous situation which *will* result in serious or fatal injury if not avoided. This symbol is used only in the most extreme conditions.

 **WARNING:** Indicates a potentially hazardous situation which *could* result in serious injury if not avoided.

 **CAUTION:** Indicates a potentially hazardous situation which *may* result in minor or moderate injury if not avoided. It may also be used to alert against unsafe practices.

 Indicates the acceptable lowest barometric pressure conditions in which this unit can be shipped.

 Indicates package should be handled with these symbols pointing up.

 **FRAGILE:** Handle package with care.

 Indicates this package must be kept dry.

**INDUSTRIAL ELECTRICAL EQUIPMENT**  
With respect to electrical shock, fire, mechanical and other specified hazards only in accordance with UL1450.

 **Electrical shock hazard**  
**Risk of electric shock present. Make sure power is disconnected before attempting this procedure.**









 **Equipment Alert:** Verify all leaks are sealed. Air leaks are main cause of premature compressor failures.

 **WARNING:** To Avoid Serious Burns: Do not touch surface during operation.

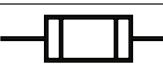
 **ON OFF** Indicates the ON and OFF position for the Equipment power Switch

 Indicates the acceptable maximum relative humidity for shipping.

 **Indicates the acceptable shipping temperature range.**  
+50 °C  
+122 °F  
-29 °C  
-20 °F

Symbol	Description
	A/C power
	
	Air outlet port
	Fuse location
	Ground
	Hour meter
	Over-temp indicator light
	Power on indicator light
	Pressure gauge
	Pressure regulator valve

**INTENDED USE:**

To provide compressed air for use with industrial or laboratory devices as a primary or back-up air source.

JUN-AIR compressor systems meet or exceed the most current and highest safety standards, which are:

- UL1450, 4th edition
- CSA C22.2 68
- ISO 9001:2008
- Ingress protection: IP50
- 2006 / 95 / EC Directive
- RoHS compliant

To ensure the safety potential of this equipment is achieved, please:

Make sure your equipment is installed according to the instructions provided in this manual and make sure the installation checklist is completed prior to starting the equipment.



**DANGER:** The equipment is not suitable for use in the presence of a flammable anesthetic mixture or with oxygen or nitrous oxide. **DO NOT OPERATE THE EQUIPMENT IF THESE CONDITIONS EXIST.**

**Protection against electrical shock:**

Provide proper grounding per NFPA 70 (NEC 2008). Do not become a current path from the equipment to ground through your body.

**Transportation/Storage Conditions:**

Temperature range -28 °C/-4 °F to 65 °C /149 °F.  
Relative Humidity 10% to 95% (non-condensing).  
Barometric pressure minimum of 372 mm Hg (49 kPa)

Keep system dry at all times.

Do not stack units during shipment or installation.

**Important: Refer servicing to an authorized service representative.**

**UNPACKING**

1. Examine contents for damage prior to removing shipping carton.
  - a. If shipping damage is found, immediately contact the freight carrier to file a claim.
2. Remove banding strap from carton.
3. Remove carton top and note accessory bag.
4. Remove top retaining and side inserts.
5. Visually inspect the entire compressor system for shipping damage.
  - a. If shipping damage is found, immediately contact the freight carrier to file a claim.
6. Using caution, remove compressor system from remaining packaging. Retain packaging material for future use, if necessary.

**NOTE:** If parts are missing, contact the supplier.

# System Features

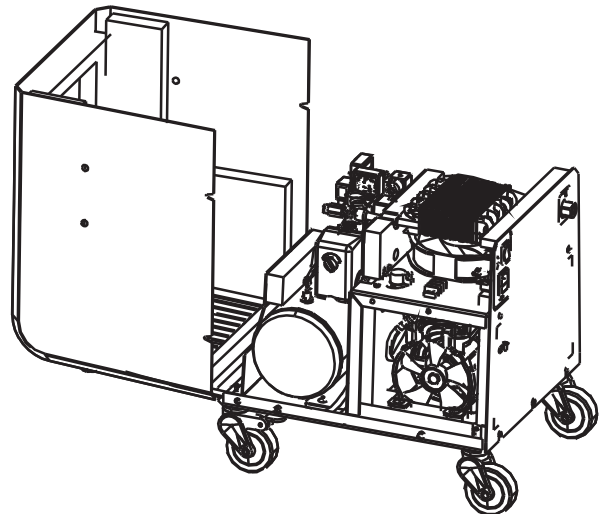
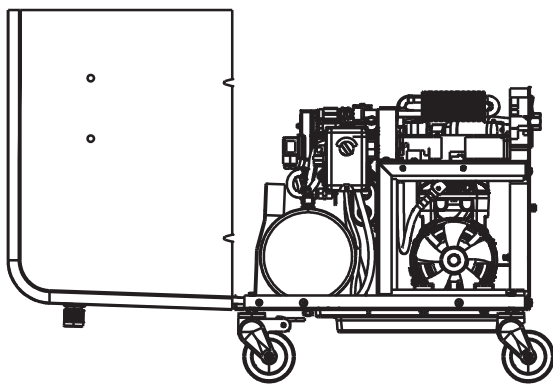
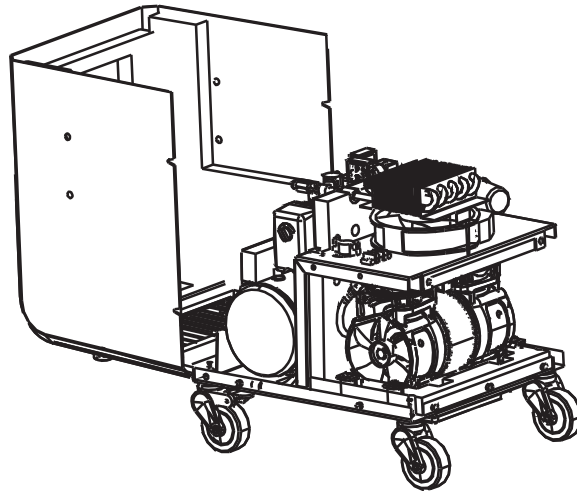

# System Features

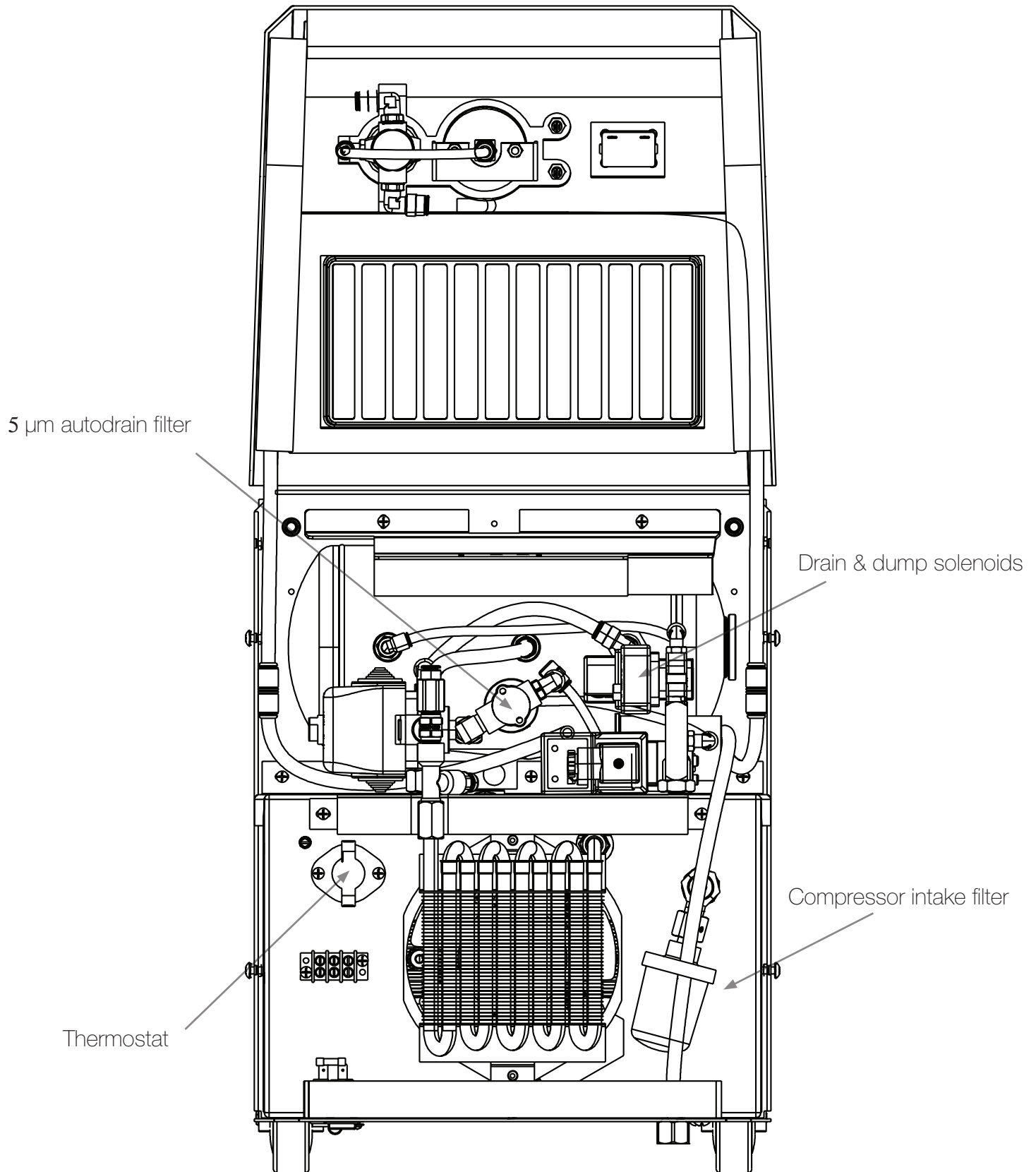



## Installation Safety Data

### PLACEMENT:

- Indoor use only
- Dust free, climate controlled room
- DO NOT install/operate in an enclosed area where ambient temperature could fall below 10 °C/50 °F, or rise above 40 °C/104 °F. Reference specifications table on page 13.
- Maintain minimum 12" (300mm) clearance on all sides and top of all compressors for service access and cooling.
- Ensure unit stands level and firmly on the floor.



Indicates the ON and OFF position for the equipment power switch (system breaker)

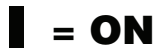

When **ON**, the indicator light will illuminate and voltage **WILL** be supplied to system.

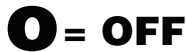

When **OFF**, the indicator light will NOT illuminate and voltage **WILL NOT** be supplied to the system.

### PERSONAL SAFETY:



**DANGER: Danger of fire or explosion when using flammable substances. Do not operate the compressor in an area containing combustible gases or anesthetic mixtures.**



**CAUTION: Never leave children unattended near compressor when in use.**



**WARNING: Property damage and/or personal injury may result if directions are not followed or manufacturer's replacement parts/accessories are not used.**



**WARNING: Connect only equipment suitable for listed maximum pressure of the compressor.**



**WARNING: DO NOT install on surfaces with more than a 10° incline.**



**WARNING: If unit is operating in high altitude, adjustments to time, temperature or pressure may be required. Consult service technician prior to making any adjustments.**



**WARNING: A leaking pressure relief valve may indicate a need for adjustment or repair. Consult service technician prior to making any adjustments.**

**INSTALLATION SAFETY DATA, continued****ELECTRICAL SAFETY:**



- Verify main's voltage and frequency specified on the compressor system are the same as the supply power's mains.
- Never operate unit outside the specified voltage range (see "INSTALLATION SITE REQUIREMENTS" for range).
- See "SPECIFICATIONS" for more electrical information.
- Indicator light on the system cover displays when system power is supplied and power switch is on.

**ELECTROMAGNETIC INTERFERENCE (EMI):**

The JUN-AIR compressor system is designed to avoid electromagnetic emissions interference with surrounding electrical equipment. Due to the vast assortment of electrical equipment available, it is possible that some interference may be experienced by the end customer. If interference is experienced, the device that is creating interference should be removed from the room where the compressor system is located. If the interference persists, then it may be necessary to confirm that both devices are connected to isolated (separated) circuits per "INSTALLATION- ELECTRICAL CONNECTIONS" in this manual. If the problem still occurs, then the two devices should be moved as far apart as possible. Finally, if the problem cannot be eliminated, contact JUN-AIR.

 **CAUTION: Routinely inspect any and all power cords for cuts and abrasions. Discontinue use and have authorized service representative replace cord if damaged.**

 **WARNING: Use of an extension cord is not advisable. An undersized extension cord will cause a drop in line voltage and loss of power. Overheating will result. Death or Fire from electrical shock could occur.**

 **WARNING: Electric shock could occur as a result of improper grounding. This product must be grounded according to NEC regulations and all local codes.** 

 **WARNING: Always turn off compressor and remove power from unit when servicing or removing electrical cover. Lock out power at the breaker prior to servicing.**

 **WARNING: Do not plug into an ungrounded outlet or adapter. Reliable earth ground can only be achieved when compressor is connected to a grounded receptacle.**



**WARNING: To Avoid Serious Burns:**  
Do not touch compressor during operation and allow it to cool prior to servicing.

 **WARNING**



**Electrical Shock Hazard**

The wire with insulation that is green or green with yellow stripes is the grounding wire.

Install this product in a dry location.

Install this product where it will be weather protected.

This product must be properly grounded. Electrically ground this product per local codes.

Check the condition of the power supply wiring.

Do not permanently connect this product to wiring that is not in good condition or is inadequate for the requirements of this product.

Follow all local applied codes prior to installation.

Failure to follow these instructions can result in death, fire or electrical shock.

## INSTALLATION - SITE REQUIREMENTS

Specifications	100 V 50/60 Hz	115 V 50/60 Hz	230 V 50/60 Hz
<b>Electrical</b>			
Voltage min./max.	+/- 10%	+/- 10%	+/- 10%
Full load amps (50 Hz)	5.0	4.8	2.6
Full load amps (60 Hz)	5.8	5.3	2.9

# BEFORE YOU INSTALL...



**Equipment Alert:**  
Compressors are oil-less and require NO lubrication.



**Equipment Alert:**  
Compressor system must be installed in a temperature-controlled and/or ventilated room to ensure operational ambient temperature of 50 °F to 104 °F (10 °C to 40 °C). A 12-inch clearance is required on each side and top of unit to allow air flow. Failure to do so could cause premature loss of system performance and void warranty.

## INSTALLATION - PNEUMATIC CONNECTIONS



**WARNING:** The system should only be installed by qualified personnel. The system should be installed in a clean, dry, well ventilated area on a solid, level surface.

1. Attach hose to output side connection of compressor system and connect opposite end of hose to device air inlet connection.

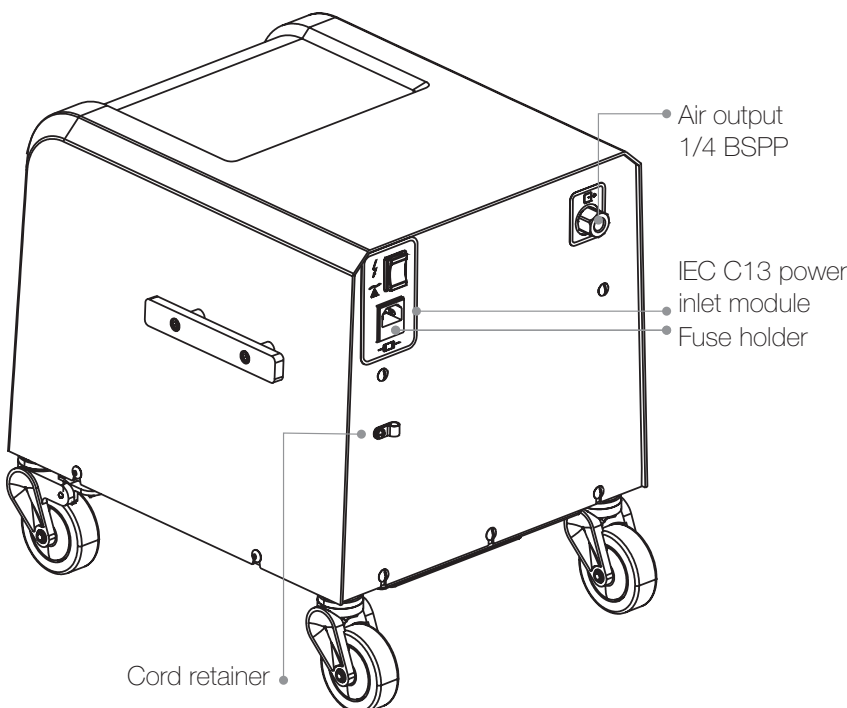

## INSTALLATION - ELECTRICAL CONNECTIONS



**WARNING:** Connect in accordance with NEC Class 2 wiring methods and call local codes.

\*Refer to "SPECIFICATION" section for Electrical Ratings in this manual.

**NOTE:** If fuse replacement is required, then a rated resistance time-delay fuse should be used.

1. Remove screw retaining cord anchor from back panel on compressor. Place cord anchor around cord and secure to the back panel using screw provided ensuring enough slack in cord to connect to compressor.
2. Attach cord IEC plug to back of compressor ensuring its securely seated in connector.
3. Plug in opposite end of cord to outlet providing proper voltage and frequency required by compressor system per specifications.

## SYSTEM CHECKS AND TESTS

1. Turn power on. The compressor should run and the storage tank will begin to pressurize.



**WARNING: Always turn off compressor and remove power when removing system cover.**

2. Check the incoming line voltage. It should be a minimum of 103 or 207 volts and should not exceed 127 or 253 volts. This voltage should remain within this range while compressor system is running. If voltage does not remain within the specified range, contact JUN-AIR.

**NOTES:**

- System safety relief valve set to 9 Bar [135 psi].
- System pressure switch set to max. 8 Bar [116 psi] cutout, and 6 Bar [87 psi] cut in. (See table below for details)
- Monitor line pressure gauge when testing for leaks.
- You may use soapy water to check for any pressure leaks.

**NOTE:** If the internal tank pressure gauge drops more than 5 psi in 5 minutes, an air leak exists. Locate the leak(s) and repair.

System	Voltage (V)	Frequency (Hz)	Charge Time	Recover Time	Cut-In Pressure	Max. Pressure
1770008	115	50/60	<40 sec @ 50Hz <35 sec @ 60Hz	<20 sec @ 50Hz <15 sec @ 60Hz	87 psi/ 6 bar	116 psi / 8 bar
1770009	230	50/60				
1770010	230	50/60				
1770018	100	50/60				

## OPERATION

1. Once the compressor system is completely installed and ready for operation, it can be turned on using the power switch on the back panel. A light on the compressor cover will turn on to indicate that voltage is supplied to the compressor, and the system is operational.
2. The system will provide clean dry air and is factory preset to operate approximately at 6 - 8 Bar [87 - 116 Psi] (see "SPECIFICATIONS"). Check the internal tank gauge reading to verify pressure settings. If this setting needs to be adjusted, contact your authorized dealer. Use the adjustable knob on the front cover to adjust output air pressure.
3. When the compressor system is not in use, it should be powered down by turning it off, using the power switch on the back panel. (Pressure must be released from the system before transporting or removing connections). The indicator light on the compressor cover will turn off once the switch is turned off.

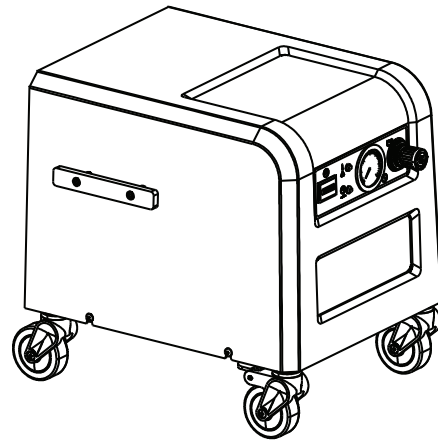
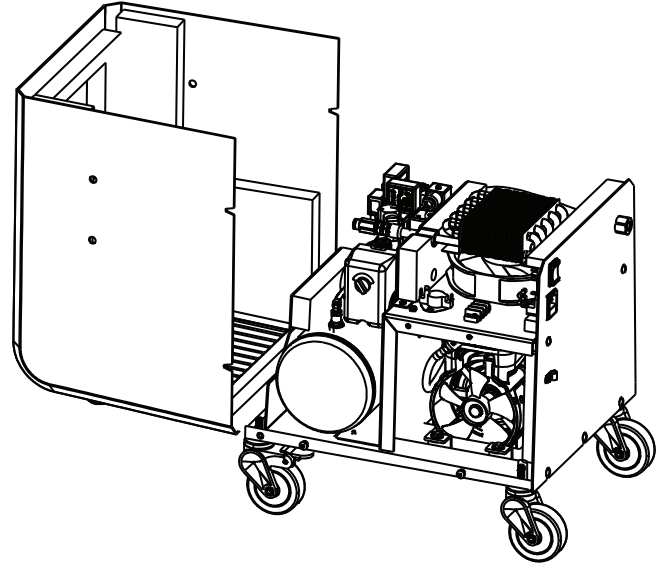

Specifications	NO DRYER					
	100V		115V		230V	
	50Hz	60Hz	50Hz	60Hz	50Hz	60Hz
<b>Model Numbers</b>	1770018		1770008		1770009 (NA) 1770010 (EU/UK)	
Continuous System Output Flow @ 4 bar (60 psi)	"46 LPM 1.6 CFM"	"51 LPM 1.8 CFM"	"46 LPM 1.6 CFM"	"51 LPM 1.8 CFM"	"46 LPM 1.6 CFM"	"51 LPM 1.8 CFM"
Continuous System Output Flow @ 8 bar (120 psi)	"27 LPM 1.0 CFM"	"31 LPM 1.1 CFM"	"27 LPM 1.0 CFM"	"31 LPM 1.1 CFM"	"27 LPM 1.0 CFM"	"31 LPM 1.1 CFM"
Cut-in Pressure (compressor ON - adjustable)	"6 bar 90 psi"					
Cut-out Pressure (compressor OFF - adjustable)	"8 bar 120 psi"					
Maximum Compressor Output Pressure (adjustable)	"8 bar 120 psi"					
Dew Point Suppression *	N/A					
Air Filtration	5 µm					
Safety Relief Valve Pressure	9.3 bar (135 psi)					
High Temperature Indication	≥ 60 °C [140 °F] compressor chamber					
Air Connections	1/4" BSPP					
Current	5.0 Amps	5.8 Amps	4.8 Amps	5.3 Amps	2.6 Amps	2.9 Amps
Power Consumption	450W	550W	500W	600W	550W	650W
Fuse Size (Amps)	12.5 TD					
Sound Level (dBA)	46 dB(A)	48 dB(A)	46 dB(A)	48 dB(A)	46 dB(A)	48 dB(A)
Operating Ambient Conditions	5 °C to 35 °C 40 °F to 95 °F 10 - 95% RH (non-condensing)		5 °C to 40 °C 40 °F to 104 °F 10 - 95% RH (non-condensing)			
Storage Ambient Conditions	-20 °C to 65 °C -4 °F to 149 °F 10 - 95% RH (non-condensing)		-20 °C to 65 °C -4 °F to 149 °F 10 - 95% RH (non-condensing)			
System Dimensions W x H x D	406 mm x 495 mm x 439 mm [16" W x 19.5" D x 17.3" H]					
System Weight	29.5 kg [65 lb]					
System Shipping Weight	35 kg [77 lb]					
Regulatory Approvals	UL 1450 / CE		UL 1450 / CSA 22.2 / CE		UL 1450 / CSA 22.2 / CE	



\* Membrane Dryer Specifications available upon request.

## MAINTENANCE

By performing regularly scheduled maintenance, you will ensure your compressor system provides you with years of superior performance.

Also to extend your compressor system life, please do the following:

- Keep compressor system clean and free of dirt and debris.
- Keep area surrounding compressor system clean and free of debris.
- Maintain recommended controlled ambient temperature – high temperatures will shorten life.
- Verify all leaks are sealed.

 <b>WARNING</b>

<b>Electrical Shock Hazard</b> <b>Disconnect electrical power supply cord before performing maintenance on this product.</b> <b>If product is hard wired into system, disconnect electrical power at the circuit breaker or fuse box before performing maintenance on this product.</b> <b>Failure to follow these instructions can result in death, fire or electrical shock.</b>

 <b>WARNING</b>
<b>Injury Hazard</b> <b>Product surfaces become very hot during operation, allow product surfaces to cool before handling.</b> <b>Air stream from product may contain solid or liquid material that can result in eye or skin damage, wear proper eye protection.</b> <b>Clean this product in a well ventilated area.</b> <b>Failure to follow these instructions can result in burns, eye injury or other serious injury.</b>

	<b>WARNING: Always disconnect power before servicing. The head(s) surface(s) can be very hot depending on compressor usage. Do not touch these parts during or directly after operation.</b>
---	--

### Changing or Replacing System Intake Filter Element:

1. Turn off compressor system.
2. Disconnect compressor system from electrical power.
3. Pull intake filter element from system cover and inspect for tears or damage.
4. If cleaning, wash and clean element using warm, soapy water. Ensure element is completely dry before reinstalling. If replacing, discard old element and install new.
5. Install filter element into cover ensuring element is retained fully by cover.
6. Reconnect electrical power to system.

**NOTE:** Filter kits are available for the Compressor System (see OPTIONS AND ACCESSORIES).

### Replacing Coalescing Filter Element:

1. Turn off compressor system.
2. Disconnect compressor system from electrical power.
3. Bleed air from system.
4. Remove cover by removing handle bolts (4) and loosening cover screws (4) to tilt cover forward
5. Rotate coalescing filter bowl and drop down slightly to remove. Use caution to not damage or kink the drain tubing.
6. Remove filter element by turning completely out and discard.
7. Install a new 5 micron filter element (verify correct part is installed).
8. Position filter bowl by pushing up slightly and rotating into place. Verify the drain tubing is not kinked or damaged.
9. Ensure drain tubing is through the base plate and in the evaporator panel.
10. Replace cover and tighten screws.
11. Reconnect electrical power to system.



## MAINTENANCE (continued)

### Testing Compressor for Leaks:

1. Close valve to device.
2. Run compressor until it reaches maximum operating pressure (approximately 116 Psi/8 bar).
3. Turn off compressor system.
4. Let compressor system set for 5 minutes.
5. If the pressure drop is more than 5 Psi /0.5 bar within the five minutes, leaks must be repaired.
6. Repair if needed, using soapy water to determine where leaks are occurring.
7. Open valve to facility plumbing.



**WARNING: Disposal of system or components (once deemed non-usable by the authorized dealer and end user) should be done in accordance with all local codes. Contact your local waste management authorities to determine proper disposal methods.**



**WARNING: Do not exceed the OSHA requirements of 30 Psig/2 bar air for cleaning purposes.**

### Replacing Compressor Intake Filter Element:

1. Turn off compressor system.
2. Disconnect compressor system from electrical power.
3. Open cover by removing handle bolts (4) and loosening cover screws (4).
4. Remove intake filter cap by pressing it in and rotating while holding base of filter.
5. Remove old intake filter element and discard.
6. Install replacement filter element and replace filter cap.
7. Replace the cover and secure screws.
8. Reconnect electrical power to system.



Preventive maintenance schedule		
Timing	What	P/N
Monthly	Remove and clean system front intake filter	-
Annually	Replace front intake filter	AS620A
Annually	Replace in-line filter element	AS620A
Annually	Replace compressor intake filter element	AS620A
Annually	Replace evaporator tray foam element	AS620A
Annually	Test for air leaks	-
Annually	Inspect system for functionality using system checks and tests	-
8,000 hours	Rebuild compressor	K694

## TROUBLESHOOTING CHART

Problem	Possible Cause(s)	Possible Solution(s)
1. Motor/compressor does not start	a. No electric power	a. Check circuit breaker at main power source.
	b. Power not connected	b. Check
	c. Defective power switch	c. Power switch needs to be replaced. Call your authorized dealer for service. Check compressor power switch is in the ON position.
	d. Fuse is blown/damaged	d. Check fuse(s) in electrical inlet.
2. Motor tries to start, circuit breaker trips	a. Voltage too low. If each compressor head runs separately, but not together, the voltage is too low.	a. Compressor requires a minimum of 103/208 volts. If the voltage is too below required minimum, a buck-boost transformer must be installed.
	b. Solenoid valve does not open when compression cycle ends.	b. Check the solenoid valve. If it does not open at the end of the cycle, call authorized dealer for service.
	c. Power supply cable too small	c. See SITE REQUIREMENTS.
	d. Loose electrical connection	d. Call authorized dealer for service.
3. Unusual or excessive noise	a. Intake filter(s) not seated correctly	a. Remove filter(s) and replace if clogged or dirty. When installing, make sure filter chamber is clean and filter is sealed properly.
	b. Intake filter(s) clogged or dirty	b. Replace filter(s).
	c. Motor or compressor noise	c. Call authorized dealer for service.
	d. Air leaks	d. Close the storage tank outlet valve. Check all fittings for leaks. If leak is found, call authorized dealer for service.
	e. Check cooling fan	e. If fan is loose or broken, call authorized dealer for service.

(Continued on next page)

## TROUBLESHOOTING CHART (Continued)

Problem	Possible Cause(s)	Possible Solution(s)
4. Compressor cycles but does not build up pressure to 116 Psi/8 bar	a. Solenoid valve does not close or leaks when compressor runs	a. Check the solenoid valve. Call authorized dealer for service.
	b. Clogged or dirty intake filters	b. Replace intake filters.
	c. Leak in compressor system	c. Close the storage tank outlet valve. Check all fittings for leaks. If leak is found, call authorized dealer for service. (See "Testing Compressor for Leaks" in MAINTENANCE section.)
	d. Leak in device air system	d. With the power switch ON, ensure the compressor is running. Close the regulator and wait for the compressor system to shut off at 116 Psi. Wait 5 minutes and open the storage tank outlet valve. If the pressure drops (by more than 5 Psi/0.5 bar or the compressors start again) the leak is in the office air lines or delivery units. Contact your authorized dealer for service.
	e. Pressure switch out of adjustment	e. Call authorized dealer for service or detailed instructions to adjust pressure switch.

**WARRANTY POLICY**

If within the warranty time limits described below, the compressor system or any of its components fail under normal use and service, the original user-owner must contact an authorized JUN-AIR dealer with the product sale and service records. Should the dealer not be able to complete the repair, the dealer may contact JUN-AIR for disposition. The product's model and serial number, the installation date and the JUN-AIR invoice number must be furnished. Transportation charges both ways must be paid by the dealer. If upon receipt at the factory, an examination reveals faulty or defective original parts, materials, or workmanship, JUN-AIR will, at its sole discretion, rebuild or replace. This warranty does not cover damages caused by misuse, abuse, accident, or neglect. Unauthorized alterations or repairs made outside our factory will cancel this warranty and charges for them will not be allowed.

**COMPRESSOR SYSTEMS**

All compressor systems sold and installed by authorized JUN-AIR dealers are warranted to be free from defects in parts, workmanship, and materials for 8,000 hours of operation or two (2) years from date of purchase, whichever occurs first.

This warranty excludes normal expected service items such as but not limited to: filters/filter kits, o-rings, and hoses. It also excludes add-on accessories that carry their own specific manufacturer's warranty.

**PARTS AND ACCESSORIES**

<b>Part no.</b>	<b>Description</b>	<b>Kit contents</b>
4736609	European power cord	
4736621	UK / GBR power cord	
4736620	Asian / Australian power cord	
4736915	IEC C13/C14 power cord	
4736882	US 115 V power cord	
4736931	US 230 V power cord	
AS620A	Filter kit (annual)	Intake filters, evaporator tray foam
K694	Compressor rebuild kit	O-rings, seals, cup, cylinder
AS623	Rubber Mounting Footing Kit	Four (4) rubber isolation feet and washers



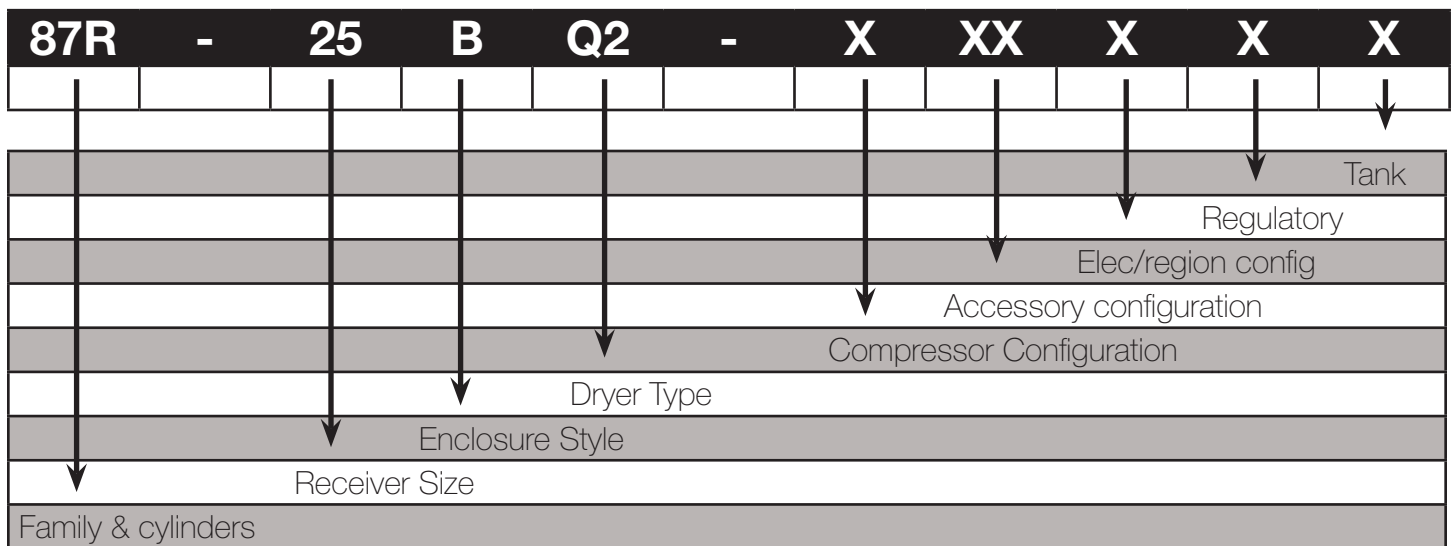

Family & cylinders	Receiver Size	Enclosure Style	Dryer Type
86R = single cylinder & small bore (low flow)	4, 15, 25, 40	B = Basic or Open	Q = iQ dryer (2, 3, or 6 size)
87R = twin cylinder & large bore (high flow)		M = Metal Cabinet	A = Membrane Dryer
		P = Plastic Cover	

Compressor	Accessory	Elec/region config	Regulatory	Tank
A Single Cylinder, Low Stroke	Manual tank drain, 5µ F/R manual drain, no bottle, pressure switch unloader	100/50 or 60 Japan (NEMA 1-15 or 5-15?)	CE	CE
B Single Cylinder, High Stroke (0.35")	Manual tank drain, 5µ F/R auto drain, with bottle	120/50 or 60 NA (NEMA 5-15)	CSA	ASME
C Single Cylinder, High Stroke (0.42") Bent Valve (100psi max)	Manual tank drain, 5µ F/R manual drain, 0.01µ Coalescing Filter, no bottle	220-240 50 or 60 NA (NEMA 6-15)	cULus	ASME Singapore
D	Manual tank drain, 5µ F/R auto drain, 0.01µ Coalescing Filter, with bottle	220-240 50 or 60 EU (CEE 7/7)	CE/cULus	GB (china)
E	Manual tank drain, 5µ F/R auto drain, no bottle, pressure switch unloader	220-240 50 or 60 EU (CEE 7/7) & GB adaptor	CCC	CRN
F	Manual tank drain, 5µ F/R auto drain, 0.01µ Coalescing Filter, no bottle	220-240 50 or 60 CH (NEMA 1-15 or AS-3112)	cCSAus	ASME/CE
G Dual Parallel Cylinder, Low Stroke		220-240 50 or 60 AU (AS-3112)		ASME/CRN
H Dual Parallel Cylinder, High Stroke (0.37")		220-240 50 or 60 GB (IEC Type G)		CE/UL
J Dual Parallel Cylinder, High Stroke (0.42") Bent Valves				
K	Auto tank drain, 5µ F/R auto drain, with bottle			
L	Auto tank drain, 5µ F/R auto drain, 0.01µ Coalescing filter, with bottle			
M	Auto tank drain, 5µ Filter auto drain, regulator, solenoid unloader, no bottle			
N Dual Staged Cylinders, Std Stroke	Auto tank drain, 5µ Filter auto drain, regulator, solenoid unloader, with bottle		None	
P Dual Independent Cylinders, Std Stroke				
R				
S Special compressor configuration	OEM Specific Model	Special voltage/plug	Special	Special

**INSTALLATION CHECKLIST**

- Check system for shipping damage
- Remove packaging cardboard
- Verify installation kit components
- Relocate unit to operating location and place per "SITE REQUIREMENTS"
- Attach pneumatic fittings and connections per "SITE REQUIREMENTS" and "INSTALLATION PNEUMATIC CONNECTIONS".
- Attach electrical connections per "SITE REQUIREMENTS" and "INSTALLATION - ELECTRICAL" Requirements
- Verify incoming line voltage meets minimum and maximum values
- Turn on power to dedicated circuit and ensure unit starts. If not, refer to "TROUBLESHOOTING GUIDE"
- Perform checks

**Gast Manufacturing**

P.O. Box 97  
2300 M139 Highway  
Benton Harbor, MI 49023-0097  
Ph: 269-926-6171  
Fax: 269-925-8288

**Gast Group Limited  
c/o IDEX Trading (Shanghai) Co., LTD**

Room 3502-3505  
No. 1027 Chang Ning Road,  
Zhaofeng Plaza  
Shanghai, China 200050  
Phone +86-21-52415599  
Fax +86-21-52418339

**Gast Group Ltd.**

Unit 11, The I O Centre  
Nash Road  
Redditch, B98 7AS  
United Kingdom  
Phone +44 (0)1527-504040  
Fax +44 (0)1527-525262

**[www.JUN-AIR.com](http://www.JUN-AIR.com)**