

## ROTIXA 500 RS



Ⓓ	<b>Bedienungsanleitung</b> .....	<b>13</b>
Ⓔ	<b>Operating Manual</b> .....	<b>45</b>
Ⓕ	<b>Mode d'emploi</b> .....	<b>76</b>
Ⓖ	<b>Istruzioni per l'uso</b> .....	<b>108</b>

Andreas Hettich GmbH & Co. KG  
Föhrenstraße 12, D-78532 Tuttlingen / Germany  
Phone +49 (0)7461 / 705-0  
Fax +49 (0)7461 / 705-1125  
info@hettichlab.com, service@hettichlab.com  
www.hettichlab.com



Single Registration Number:

DE-MF-000010680

© 2014 by Andreas Hettich GmbH & Co. KG

All rights reserved. No part of this publication may be reproduced without the prior written permission of the copyright owner.

Änderungen vorbehalten! , Modifications reserved! , Sous réserve de modifications ! , Con riserva di modifiche!

AB4950DEENFRIT / Rev. 12



## EG-Konformitätserklärung EC Declaration of conformity

des Herstellers

of the manufacturer

**Andreas Hettich GmbH & Co. KG • Föhrenstrasse 12 • D-78532 Tuttlingen • Germany  
SRN: DE-MF-000010680**

Hiermit erklären wir in unserer Verantwortung,  
dass das bezeichnete Gerät:

Geräteart	<b>Zentrifuge</b>
Name	<b>ROTIXA 500 RS</b>
Basic UDI-DI	<b>4050674010002Q2</b>
GMDN	<b>15115</b>
Klassifizierung	<b>Medizinprodukt, Klasse IIa (Anhang VIII, Kapitel III, Regel 3)</b>
Gemäß	<b>Verordnung (EU) 2017/745 Anhang IX</b>
Mitwirkende Benannte Stelle	<b>mdc medical device certification GmbH; CE 0483 Kriegerstraße 6; 70191 Stuttgart; Germany</b>

inklusive des mit dem Gerät  
konformitätsbewerteten Zubehörs laut Zubehörliste  
der zugehörigen technischen Dokumentation, den  
einschlägigen Bestimmungen der Verordnung  
(EU) 2017/745 über Medizinprodukte entspricht.

### Zweckbestimmung

Bei dem vorliegenden Gerät handelt es sich um  
eine Laborzentrifuge, die für medizinische  
Anwendungen geeignet ist. Ihre ausschließliche  
therapeutische Zweckbestimmung besteht darin,  
Blut in Blutbeutelssystemen zu zentrifugieren. Die  
separierten Blutkomponenten werden von einem  
anderen Gerät (Separator) in entsprechende  
Satellitenbeutel überführt. Die so gewonnenen  
Einzelkomponenten werden dann für die  
Transfusion oder Autotransfusion eingesetzt.  
Die Zentrifuge darf nur von Fachpersonal in  
Blutspendediensten oder Krankenhäusern  
betrieben werden.  
Die Zentrifuge ist nur für die oben genannten  
Verwendungszwecke bestimmt. Eine andere oder  
darüberhinausgehende Benutzung gilt als nicht  
bestimmungsgemäß. Für hieraus entstehende  
Schäden haftet die Firma Andreas Hettich GmbH &  
Co. KG nicht. Zur bestimmungsgemäßen  
Verwendung gehört auch die Beachtung aller  
Hinweise aus der Bedienungsanleitung und die

We hereby declare under our responsibility  
that the designated device:

Type of device	<b>Centrifuge</b>
Name	<b>ROTIXA 500 RS</b>
Basic UDI-DI	<b>4050674010002Q2</b>
GMDN	<b>15115</b>
Classification	<b>Medical Device, class IIa (Annex VIII, Chapter III, Rule 3)</b>
according to	<b>Regulation (EU) 2017/745 Annex IX</b>
Involved Notified Body	<b>mdc medical device certification GmbH; CE 0483 Kriegerstraße 6; 70191 Stuttgart; Germany</b>

and its accessories, which are listed in the related  
technical documentation and whose conformity  
has been assessed together with the device,  
complies with the relevant provisions of the  
Regulation (EU) 2017/745 on medical devices.

### Intended use

This device is a laboratory centrifuge suitable for  
medical applications. Their exclusive therapeutic  
purpose is to centrifuge blood in blood bag  
systems. The separated blood components are  
transferred by another device (separator) into  
corresponding satellite bags. The individual  
components obtained in this way are then used  
for transfusion or autotransfusion.

The centrifuge is only to be operated by qualified  
personnel working for blood donation services or  
hospitals.

The centrifuge is only intended for the uses  
referred to above. Any other use or use beyond  
this is considered improper. Andreas Hettich  
GmbH & Co. KG shall not be liable for any  
damage arising from this. Intended use also  
includes the observation of all instructions in the  
Operating Manual and compliance with the  
required inspection and maintenance intervals.



**Einhaltung der Inspektions- und Wartungsintervalle.**

Das Gerät entspricht auch den anwendbaren Bestimmungen der folgenden europäischen Richtlinien und Verordnungen

- 2006/42/EG „Maschinenrichtlinie“
- 2014/30/EU „EMV-Richtlinie“
- 2014/35/EU „Niederspannungsrichtlinie“
- 2011/65/EG „RoHS-Richtlinie“  
(ohne Beteiligung einer benannten Stelle)
- (EG) 1907/2006 „REACH Verordnung“  
(ohne Beteiligung einer benannten Stelle)

**Angewandte Normen:**

Siehe Liste der angewandten Normen, die Teil der technischen Dokumentation ist.

The device also complies to the applicable provisions of the following European directives, ordinances and standards

- 2006/42/EC "Directive on machinery"
- 2014/30/EU "EMC Directive"
- 2014/35/EU "Low Voltage Directive"
- 2011/65/EC "RoHS Directive"  
(without involvement of a notified body)
- (EC) 1907/2006 "Regulation on REACH"  
(without involvement of a notified body)

**Standards applied:**

See the list of applied standards that forms part of the technical documentation.

Tuttlingen, 21.04.2023

Klaus-Günter Eberle  
Geschäftsführer, Chief Executive Officer



Diese Konformitätserklärung ist gültig von 21.04.2023 bis 25.08.2027

This declaration of conformity is valid from 21.04.2023 until 25.08.2027



## Déclaration de conformité CE EC Declaration of conformity

du fabricant

of the manufacturer

**Andreas Hettich GmbH & Co. KG • Föhrenstrasse 12 • D-78532 Tuttlingen • Germany  
SRN: DE-MF-000010680**

Par la présente, nous déclarons sous notre responsabilité que le dispositif désigné :

We hereby declare under our responsibility that the designated device:

Type de dispositif **Centrifugeuse**  
Nom **ROTIXA 500 RS**  
UDI-DI de base **4050674010002Q2**  
GMDN **15115**  
Classification **Dispositif médical, classe IIa  
(annexe VIII, chapitre III, règle 3)**  
Conformément au **règlement (UE) 2017/745  
annexe IX**  
Organisme notifié **mdc medical device  
participant certification GmbH ; CE 0483  
Kriegerstraße 6 ; 70191  
Stuttgart ; Germany**

Type of device **Centrifuge**  
Name **ROTIXA 500 RS**  
Basic UDI-DI **4050674010002Q2**  
GMDN **15115**  
Classification **Medical Device, class IIa  
(Annex VIII, Chapter III, Rule 3)**  
according to **Regulation (EU) 2017/745  
Annex IX**  
Involved **mdc medical device certification  
Notified Body GmbH; CE 0483  
Kriegerstraße 6; 70191  
Stuttgart; Germany**

avec les accessoires évalués comme conformes au dispositif d'après la liste d'accessoires de la documentation technique correspondante, satisfait aux dispositions pertinentes du règlement (UE) 2017/745 relatif aux dispositifs médicaux..

and its accessories, which are listed in the related technical documentation and whose conformity has been assessed together with the device, complies with the relevant provisions of the Regulation (EU) 2017/745 on medical devices.

### utilisation conforme aux dispositions

Le présent appareil est une centrifugeuse de laboratoire adaptée aux applications médicales. Son utilisation thérapeutique est exclusivement la centrifugation de sang dans des systèmes de poches de sang. Les composants sanguins séparés sont transférés par un autre appareil (séparateur) dans des poches satellites correspondantes. Les composants individuels ainsi obtenus sont ensuite utilisés pour la transfusion ou l'autotransfusion. La centrifugeuse ne doit être utilisée que par du personnel spécialisé dans les services de transfusion sanguine ou les hôpitaux. La centrifugeuse est destinée uniquement aux fonctions citées ci-dessus. Toute utilisation différente ou dépassant ce cadre est considérée comme non conforme. La société Andreas Hettich GmbH & Co. n'est pas responsable des dommages qui en résultent. L'utilisation conforme aux dispositions comprend le respect de toutes les indications énoncées dans le mode d'emploi et le respect des

### Intended use

This device is a laboratory centrifuge suitable for medical applications. Their exclusive therapeutic purpose is to centrifuge blood in blood bag systems. The separated blood components are transferred by another device (separator) into corresponding satellite bags. The individual components obtained in this way are then used for transfusion or autotransfusion.

The centrifuge is only to be operated by qualified personnel working for blood donation services or hospitals.

The centrifuge is only intended for the uses referred to above. Any other use or use beyond this is considered improper. Andreas Hettich GmbH & Co. KG shall not be liable for any damage arising from this. Intended use also includes the observation of all instructions in the Operating Manual and compliance with the required inspection and maintenance intervals.



intervalles d'inspection et de maintenance.

Le dispositif satisfait également aux dispositions applicables des directives et règlements européens suivants

- 2006/42/CE « Directive relative aux machines »
- 2014/30/UE « Directive CEM »
- 2014/35/UE « Directive basse tension »
- 2011/65/UE « Directive RoHS »  
(sans intervention d'un organisme notifié)
- (CE) 1907/2006 « Règlement REACH »  
(sans intervention d'un organisme notifié)

Normes appliquées :  
voir la liste des normes appliquées qui fait partie de la documentation technique.

The device also complies to the applicable provisions of the following European directives, ordinances and standards

- 2006/42/EC "Directive on machinery"
- 2014/30/EU "EMC Directive"
- 2014/35/EU „Low Voltage Directive"
- 2011/65/EC "RoHS Directive"  
(without involvement of a notified body)
- (EC) 1907/2006 „Regulation on REACH"  
(without involvement of a notified body)

Standards applied:  
See the list of applied standards that forms part of the technical documentation.

Tuttlingen, 21.04.2023

Klaus-Günter Eberle  
Gérant, Chief Executive Officer



La présente déclaration de conformité est valable du 21/04/2023 au 25/08/2027.

This declaration of conformity is valid from 21.04.2023 until 25.08.2027



## Dichiarazione di conformità CE EC Declaration of conformity

del produttore

of the manufacturer

**Andreas Hettich GmbH & Co. KG • Föhrenstrasse 12 • D-78532 Tuttlingen • Germany  
SRN: DE-MF-000010680**

Dichiariamo sotto la nostra responsabilità, che il dispositivo designato:

We hereby declare under our responsibility that the designated device:

Tipo di dispositivo **Centrifuga**  
Nome **ROTIXA 500 RS**  
Basic UDI-DI **4050674010002Q2**  
GMDN **15115**  
Classificazione **Dispositivo medico, classe IIa (Allegato VIII, capitolo III, regola 3)**  
Ai sensi del **regolamento (UE) 2017/745 Allegato IX**  
Organismo notificato competente **mdc medical device certification GmbH; CE 0483 Kriegerstraße 6; 70191 Stuttgart; Germany**

Type of device **Centrifuge**  
Name **ROTIXA 500 RS**  
Basic UDI-DI **4050674010002Q2**  
GMDN **15115**  
Classification **Medical Device, class IIa (Annex VIII, Chapter III, Rule 3)**  
according to **Regulation (EU) 2017/745 Annex IX**  
Involved Notified Body **mdc medical device certification GmbH; CE 0483 Kriegerstraße 6; 70191 Stuttgart; Germany**

con i relativi accessori elencati nella documentazione tecnica associata, la cui conformità è stata valutata assieme al dispositivo, è conforme alle disposizioni pertinenti del regolamento (UE) 2017/745 sui dispositivi medici.

and its accessories, which are listed in the related technical documentation and whose conformity has been assessed together with the device, complies with the relevant provisions of the Regulation (EU) 2017/745 on medical devices.

### L'uso previsto

Il presente dispositivo è una centrifuga da laboratorio adatta ad applicazioni mediche. La sola destinazione d'uso terapeutico consiste nella centrifugazione di sangue in sistemi per sacche di sangue. I componenti del sangue separati vengono trasferiti da un altro dispositivo (separator) nelle corrispondenti sacche satellite. I singoli componenti così ottenuti vengono poi utilizzati per la trasfusione o l'autotrasfusione.

La centrifuga può essere utilizzata solo da personale qualificato nei servizi di trasfusione o negli ospedali.

La centrifuga è destinata solo agli usi summenzionati. Qualsiasi altra forma di utilizzo è da considerarsi non conforme. La ditta Andreas Hettich GmbH & Co. KG è responsabile per i danni eventualmente risultanti. L'uso previsto comprende anche l'osservanza di tutte le istruzioni del manuale d'uso e il rispetto degli intervalli di ispezione e

### Intended use

This device is a laboratory centrifuge suitable for medical applications. Their exclusive therapeutic purpose is to centrifuge blood in blood bag systems. The separated blood components are transferred by another device (separator) into corresponding satellite bags. The individual components obtained in this way are then used for transfusion or autotransfusion.

The centrifuge is only to be operated by qualified personnel working for blood donation services or hospitals.

The centrifuge is only intended for the uses referred to above. Any other use or use beyond this is considered improper. Andreas Hettich GmbH & Co. KG shall not be liable for any damage arising from this. Intended use also includes the observation of all instructions in the Operating Manual and compliance with the required inspection and maintenance



manutenzione.

Il dispositivo è altresì conforme alle disposizioni applicabili dei seguenti regolamenti e direttive europei

- 2006/42/CE "Direttiva macchine"
- 2014/30/UE "Direttiva EMC"
- 2014/35/UE "Direttiva sulla bassa tensione"
- 2011/65/CE "Direttiva RoHS"  
(senza il coinvolgimento di un organismo notificato)
- (CE) 1907/2006 "Regolamento REACH"  
(senza il coinvolgimento di un organismo notificato)

Norme applicate:  
vedere elenco delle norme applicate che fanno parte della documentazione tecnica.

intervals.

The device also complies to the applicable provisions of the following European directives, ordinances and standards

- 2006/42/EC "Directive on machinery"
- 2014/30/EU "EMC Directive"
- 2014/35/EU „Low Voltage Directive"
- 2011/65/EC "RoHS Directive"  
(without involvement of a notified body)
- (EC) 1907/2006 „Regulation on REACH"  
(without involvement of a notified body)

Standards applied:  
See the list of applied standards that forms part of the technical documentation.

Tuttlingen, 21.04.2023

Klaus-Günter Eberle  
Amministratore delegato, Chief Executive Officer



La presente dichiarazione di conformità è valida dal 21/04/2023 al 25/08/2027

This declaration of conformity is valid from 21.04.2023 until 25.08.2027



## Für dieses Gerät gültige Normen und Vorschriften

Das Gerät ist ein Produkt mit einem sehr hohen technischen Niveau. Es unterliegt umfangreichen Prüf- und Zertifizierungsverfahren gemäß folgenden Normen und Vorschriften in deren jeweils gültigen Fassung:

### **Elektrische und mechanische Sicherheit für Konstruktion und Endprüfung:**

Normbaureihe: IEC 61010 (entspricht der Normenreihe DIN EN 61010)

- IEC 61010-1 "Sicherheitsbestimmungen für elektrische Mess-, Steuer-, Regel- und Laborgeräte - Teil 1: Allgemeine Anforderungen" (Verschmutzungsgrad 2, Überspannungskategorie II)
- IEC 61010-2-010 "Sicherheitsbestimmungen für elektrische Mess-, Steuer-, Regel- und Laborgeräte – Teil 2-010: Besondere Anforderungen an Laborgeräte für das Erhitzen von Stoffen" (nur für Zentrifugen mit Heizung gültig)
- IEC 61010-2-011 "Sicherheitsbestimmungen für elektrische Mess-, Steuer-, Regel- und Laborgeräte - Teil 2-011: Besondere Anforderungen für Kühlgeräte" (nur für Zentrifugen mit Kühlung gültig)
- IEC 61010-2-020 "Sicherheitsbestimmungen für elektrische Mess-, Steuer-, Regel- und Laborgeräte - Teil 2-020: Besondere Anforderungen an Laborzentrifugen"
- IEC 61010-2-101 "Sicherheitsbestimmungen für elektrische Mess-, Steuer-, Regel- und Laborgeräte - Teil 2-101: Besondere Anforderungen an In-vitro-Diagnostik (IVD) Medizingeräte"

### **Elektromagnetische Verträglichkeit:**

- EN 61326-1 "Elektrische Mess-, Steuer-, Regel- und Laborgeräte - EMV-Anforderungen - Teil 1: Allgemeine Anforderungen"

### **Risikomanagement:**

- DIN EN ISO 14971 "Anwendung des Risikomanagements auf Medizinprodukte"

### **Beschränkung gefährlicher Stoffe (RoHS II):**

- EN 50581 "Technische Dokumentation zur Beurteilung von Elektro- und Elektronikgeräten hinsichtlich der Beschränkung gefährlicher Stoffe"

### **Für Konformitätsbewertungsverfahren [EL5]geltende Europäische Richtlinien:**

- EU-Qualitätsmanagementbescheinigung nach Maßgabe der Verordnung (EU) 2017/745 über Medizinprodukte Anhang IX, Kapitel I (Qualitätsmanagementsystem)  
Die Bescheinigung wird durch folgende benannte Stelle ausgestellt:

mdc medical device certification GmbH – Benannte Stelle CE 0483  
Tel: +49 (0)711 253597 0  
Fax: +49 (0)711 253597 10  
E-Mail: mdc@mdc-ce.de  
Website: www.mdc-ce.de  
Post: Kriegerstraße 6, D-70191 Stuttgart; Deutschland

Die Überwachung erfolgt gemäß Anhang IX, Abschnitt 3 der Verordnung (EU) 2017/745.  
Medizinprodukt der Risikoklasse IIa gemäß Anhang VIII, Regel 3 der Verordnung (EU) 2017/745.

- Richtlinie 2011/65/EU zur Beschränkung der Verwendung bestimmter gefährlicher Stoffe in Elektro- und Elektronikgeräten. Das EG-Konformitätsbewertungsverfahren erfolgt hierzu in alleiniger Verantwortung des Herstellers, ohne Beteiligung einer benannten Stelle.

### **Außerhalb Europas geltende Richtlinien für Medizinprodukte:**

- **USA:** QSR, 21CFR 820 "CFR Title 21 - Food and Drugs: TITLE 21- FOOD AND DRUGS, CHAPTER I - FOOD AND DRUG ADMINISTRATION DEPARTMENT OF HEALTH AND HUMAN SERVICES, SUBCHAPTER H - MEDICAL DEVICES, Part 820 QUALITY SYSTEM REGULATIONS"
- **Kanada:** CMDR, SOR/98-282 "Medical Devices Regulations"

### **Zertifiziertes Qualitätsmanagementsystem gemäß**

- ISO 9001 "Qualitätsmanagementsysteme - Anforderungen"
- ISO13485 "Qualitätsmanagementsysteme für Medizinprodukte - Anforderungen für regulatorische Zwecke"

### **Umweltmanagementsystem gemäß**

- ISO 14001 "Umweltmanagementsysteme - Spezifikation mit Anleitung zur Anwendung"

## Standards and regulations which apply to this device

The device is a high-end technical product. It is subject to extensive testing and certification procedures according to the following standards and regulations in their respectively valid version:

### Electrical and mechanical safety for design and final testing:

Standard series: IEC 61010 (conform to standards of DIN EN 61010)

- IEC 61010-1 "Safety requirements for electrical equipment for measurement, control, and laboratory use - Part 1: General requirements" (Pollution Degree 2, Excess-voltage category II)
- IEC 61010-2-010 "Safety requirements for electrical equipment for measurement, control and laboratory use - Part 2-010: Particular requirements for laboratory equipment for the heating of materials" (applied to heated centrifuges only)
- IEC 61010-2-011 "Safety requirements for electrical equipment for measurement, control and laboratory use - Part 2-011: Particular requirements for refrigerating equipment" (only valid for centrifuges with cooling)
- IEC 61010-2-020 "Safety requirements for electrical equipment for measurement, control, and laboratory use - Part 2-020: Particular requirements for laboratory centrifuges"
- IEC 61010-2-101 "Safety requirements for electrical equipment for measurement, control and laboratory use - Part 2-101: Particular requirements for in vitro diagnostic (IVD) medical equipment"

### Electromagnetic Compatibility:

- EN 61326-1 "Electrical equipment for measurement, control and laboratory use - EMC requirements - Part 1: General requirements"

### Risk management:

- DIN EN ISO 14971 "Application of risk management to medical devices"

### Restriction of Hazardous Substances (RoHS II):

- EN 50581 "Technical documentation for assessing electric and electronic devices with regard to the restriction of hazardous substances"

### European Directives applicable to conformity assessment procedures:

- EU Quality Management Certificate in accordance with Regulation (EU) 2017/745 on medical devices Annex IX, Chapter I (Quality Management System)

The certificate is issued by the following notified body:

mdc medical device certification GmbH – Notified Body CE 0483

Tel: +49 (0)711 253597 0

Fax: +49 (0)711 253597 10

Email: [mdc@mdc-ce.de](mailto:mdc@mdc-ce.de)

Website: [www.mdc-ce.de](http://www.mdc-ce.de)

Post: Kriegerstrasse 6, D-70191 Stuttgart, Germany

Monitoring is carried out in accordance with Annex IX, Section 3 of Regulation (EU) 2017/745.

Risk Class IIa medical device according to Annex VIII, Rule 3 of Regulation (EU) 2017/745.

- Directive 2011/65/EU for the restriction of use of certain hazardous substances in electric and electronic devices. Carrying out the EC conformity assessment process is the sole responsibility of the manufacturer, without the involvement of a notified body.

### Applied medical device regulations outside Europe:

- **USA:** QSR, 21CFR 820 "CFR Title 21 - Food and Drugs: TITLE 21- FOOD AND DRUGS, CHAPTER I - FOOD AND DRUG ADMINISTRATION DEPARTMENT OF HEALTH AND HUMAN SERVICES, SUBCHAPTER H - MEDICAL DEVICES, Part 820 QUALITY SYSTEM REGULATIONS"
- **Canada:** CMDR, SOR/98-282 "Medical Devices Regulations"

### Certified quality management system according to

- ISO 9001 "Quality management systems – Requirements"
- ISO13485 "Medical devices - Quality management systems - Requirements for regulatory purposes"

### Environmental management system according to

- ISO 14001 "Environmental management systems - Requirements with guidance for use"

## Normes et règles en vigueur pour cet appareil

Cet appareil est un produit avec un très haut niveau technique. Il est soumis à des vastes procédures de vérification et de certification, d'après les normes et prescriptions suivantes, dans leur version actuelle :

### Sécurité électrique et mécanique pour la construction et l'inspection finale :

Série de normes : IEC 61010 (correspond à la série de norme DIN EN 61010)

- IEC 61010-1 "Règles de sécurité pour appareils électriques de mesure, de régulation et de laboratoire - partie 1 : Prescriptions générales" (niveau de sécurité 2, catégorie de surtension II)
- IEC 61010-2-010 "Règles de sécurité pour appareils électriques de mesure, de régulation et de laboratoire – partie 2-010 : Prescriptions particulières pour appareils de laboratoire utilisés pour l'échauffement des matières" (seulement valable pour centrifugeuses avec chauffage)
- IEC 61010-2-011 "Règles de sécurité pour appareils électriques de mesure, de régulation et de laboratoire – partie 2-011 : Prescriptions particulières applicables aux refroidisseurs" (valable seulement pour centrifugeuses avec refroidissement)
- IEC 61010-2-020 "Règles de sécurité pour appareils électriques de mesure, de régulation et de laboratoire – partie 2-020 : Prescriptions particulières pour centrifugeuses de laboratoire"
- IEC 61010-2-101 "Règles de sécurité pour appareils électriques de mesure, de régulation et de laboratoire – partie 2-101 : Prescriptions particulières pour les appareils médicaux de diagnostic in vitro (DIV)"

### Compatibilité électromagnétique:

- EN 61326-1 "Matériel électrique de mesure, de commande et de laboratoire – Exigences relatives à la CEM - partie 1 : Exigences générales"

### Gestion des risques:

- DIN EN ISO 14971 "Application de la gestion des risques aux dispositifs médicaux"

### Restrictions relatives aux substances dangereuses (RoHS II):

- Norme européenne 50581 „Documentation technique pour l'évaluation des produits électriques et électroniques par rapport à la restriction des substances dangereuses“

### Directives européennes applicables aux procédures d'évaluation de la conformité :

- Certificat de gestion de la qualité UE conformément au règlement (UE) 2017/745 relatif aux dispositifs médicaux, annexe IX, chapitre I (système de gestion de la qualité)

Le certificat est délivré par l'organisme notifié suivant :

mdc medical device certification GmbH – Organisme notifié CE 0483

Tél. : +49 (0)711 253597 0

Fax : +49 (0)711 253597 10

E-mail : [mdc@mdc-ce.de](mailto:mdc@mdc-ce.de)

Site Internet : [www.mdc-ce.de](http://www.mdc-ce.de)

Adresse postale : Kriegerstraße 6, D-70191 Stuttgart; Allemagne

La surveillance est effectuée conformément à l'annexe IX, section 3, du règlement (UE) 2017/745.

Dispositif médical de classe de risque IIa selon l'annexe VIII, règle 3 du règlement (UE) 2017/745.

- Directives 2011/65/UE concernant les restrictions relatives à l'utilisation de certaines substances dangereuses dans les appareils électriques et électroniques. La procédure d'évaluation de la conformité CE est sous la seule responsabilité du fabricant, sans participation d'un organisme désigné.

### Directives pour dispositifs médicaux, valables en dehors de l'Europe :

- **USA:** QSR, 21CFR 820 "CFR Title 21 - Food and Drugs : TITLE 21- FOOD AND DRUGS, CHAPTER I - FOOD AND DRUG ADMINISTRATION DEPARTMENT OF HEALTH AND HUMAN SERVICES, SUBCHAPTER H - MEDICAL DEVICES, Part 820 QUALITY SYSTEM REGULATIONS"
- **Canada:** CMDR, SOR/98-282 "Medical Devices Regulations"

### Système de management de la qualité certifié d'après

- ISO 9001 "Systèmes de management de la qualité - Prescriptions"
- ISO13485 "Dispositifs médicaux - Systèmes de management de la qualité - Exigences à des fins réglementaires"

### Système de management environnemental d'après

- ISO 14001 "Systèmes de management environnemental - Spécification avec description pour application"

## Norme e direttive valide per questo apparecchio

L'apparecchio è un dispositivo di elevatissimo livello tecnico. È sottoposto a numerosi procedimenti di collaudo e certificazione, in conformità alle seguenti norme e direttive nella corrispondente versione di validità:

### Sicurezza elettrica e meccanica per la costruzione ed il collaudo finale:

Serie di norma: IEC 61010 (corrisponde alla serie di norma DIN EN 61010)

- IEC 61010-1 "Norme di sicurezza per apparecchiature elettriche di misurazione, di comando, di regolazione e di laboratorio - parte 1: Requisiti generali" (grado di imbrattamento 2, Categoria di sovratensione II)
- IEC 61010-2 -010 "Norme di sicurezza per apparecchiature elettriche di misurazione, di comando, di regolazione e di laboratorio - parte 2-010: Requisiti particolari per le apparecchiature di laboratorio per il riscaldamento di materiali" (valido solo per centrifughe con riscaldamento)
- IEC 61010-2-011 „Norme di sicurezza per apparecchiature elettriche di misurazione, di comando, di regolazione e di laboratorio - parte 2-011: Requisiti particolari per apparecchiature di raffreddamento“ (valido solo per centrifughe con raffreddamento)
- IEC 61010-2 -020 "Norme di sicurezza per apparecchiature elettriche di misurazione, di comando, di regolazione e di laboratorio - parte 2-020: Requisiti particolari per centrifughe di laboratorio"
- IEC 61010-2 -101 "Norme di sicurezza per apparecchiature elettriche di misurazione, di comando, di regolazione e di laboratorio - parte 2-101: Requisiti particolari per la diagnostica In-vitro (IVD) apparecchiature medicali"

### Compatibilità elettromagnetica:

- EN 61326-1 "Apparecchiature elettriche di misurazione, di comando, di regolazione e di laboratorio - requisiti di compatibilità elettromagnetica - parte 1: Requisiti generali"

### Gestione dei rischi:

- DIN EN ISO 14971 "Applicazione della gestione dei rischi ai dispositivi medici"

### Restrizione per prodotti pericolosi (RoHS II):

- EN 50581 „Documentazione tecnica per la stesura di un protocollo di valutazione delle apparecchiature elettriche ed elettroniche per quanto riguarda la restrizione per prodotti pericolosi“

### Direttive europee applicabili alle procedure di valutazione della conformità:

- certificato di gestione della qualità UE ai sensi del regolamento (UE) 2017/745 sui dispositivi medici allegato IX, capitolo I (sistema di gestione della qualità)

Il certificato è rilasciato dal seguente organismo notificato:

mdc medical device certification GmbH – Organismo notificato CE 0483

Tel.: +49 (0)711 253597 0

Fax: +49 (0)711 253597 10

E-mail: [mdc@mdc-ce.de](mailto:mdc@mdc-ce.de)

Sito web: [www.mdc-ce.de](http://www.mdc-ce.de)

Indirizzo postale: Kriegerstraße 6, D-70191 Stuttgart, Germania

Il monitoraggio deve essere effettuato in conformità alla sezione 3 dell'allegato IX del regolamento (UE) 2017/745.

Dispositivo medico di classe di rischio IIa secondo l'allegato VIII, norma 3 del regolamento (UE) 2017/745.

- Direttive 2011/65/EU per la restrizione di impiego di particolari prodotti pericolosi nelle apparecchiature elettriche ed elettroniche. Il procedimento di valutazione della conformità CE avviene al riguardo nella sola responsabilità del costruttore, senza concorso di un citato collaboratore.

### Direttive valide al di fuori dell'ambito europeo per i prodotti medicali:

- **USA:** QSR, 21CFR 820 "CFR Title 21 - Food and Drugs: TITLE 21- FOOD AND DRUGS, CHAPTER I - FOOD AND DRUG ADMINISTRATION DEPARTMENT OF HEALTH AND HUMAN SERVICES, SUBCHAPTER H - MEDICAL DEVICES, Part 820 QUALITY SYSTEM REGULATIONS"
- **Kanada:** CMDR, SOR/98-282 "Medical Devices Regulations"

### Certificato sistema di gestione della qualità, conforme a

- ISO 9001 "Requisiti per sistemi di gestione qualità"
- ISO13485 "Sistemi di gestione qualità per prodotti medicali - Requisiti per impieghi di regolazione"

### Sistema di gestione ambientale, conforme a

- ISO 14001 "Sistemi di gestione ambientale - Specificazione con istruzioni per l'applicazione"

## Inhaltsverzeichnis

1	Anwendung dieser Bedienungsanleitung.....	16
2	Bedeutung der Symbole .....	16
3	Bestimmungsgemäße Verwendung.....	17
4	Restrisiken.....	17
5	Technische Daten.....	18
6	Sicherheitshinweise .....	20
7	Auspacken und Aufstellen der Zentrifuge .....	22
8	Lieferumfang.....	22
9	Transport und Lagerung .....	23
9.1	Transport .....	23
9.2	Lagerung .....	23
10	Inbetriebnahme .....	23
11	Schnittstelle (nur bei Zentrifuge mit Schnittstelle).....	24
12	Deckel öffnen und schließen .....	24
12.1	Deckel öffnen .....	24
12.2	Deckel schließen.....	24
13	Ein- und Ausbau des Rotors.....	24
14	Gehänge in den Rotor einsetzen und herausnehmen .....	25
15	Adapter in die Gehänge einsetzen und herausnehmen .....	25
16	Beladen des Rotors.....	26
17	Verschließen von Bio-Sicherheitssystemen .....	27
18	Packanweisung HettLiner.....	28
18.1	Packen vor der Zentrifugation .....	28
18.2	Entpacken nach der Zentrifugation .....	29
19	Bedien- und Anzeigeelemente .....	30
19.1	Status-Symbole.....	30
19.2	Drehknopf .....	30
19.3	Tasten und Einstellmöglichkeiten.....	30
20	Zentrifugations-Parameter eingeben .....	31
20.1	Laufzeit .....	31
20.1.1	Zeitvorwahl .....	31
20.1.2	Dauerlauf .....	31
20.2	Drehzahl (RPM) .....	31
20.3	Relative Zentrifugalbeschleunigung (RCF/RZB) .....	31
20.4	An- und Auslauf-Parameter.....	31
20.4.1	Anlaufstufe.....	31
20.4.2	Anlaufzeit .....	31
20.4.3	Bremsstufe.....	32
20.4.4	Auslaufzeit .....	32
20.4.5	Bremsabschaltungs-Drehzahl.....	32
20.5	Radius/Temperatur .....	32
20.5.1	Radius.....	32
20.5.2	Temperatur .....	32

20.6	Automatischer Zwischenspeicher .....	32
21	Programmierung .....	32
21.1	Programm-Eingabe / -Änderung .....	32
21.2	Programm-Abruf .....	32
22	Zentrifugation .....	33
22.1	Zentrifugation mit Zeitvorwahl .....	33
22.2	Dauerlauf .....	33
23	Einstellungen während des Zentrifugationslaufes ändern .....	33
24	Integral RCF (JRCF) .....	33
25	Anzeige der maximalen Drehzahl des Rotors .....	33
26	Anzeige der maximalen RCF des Rotors .....	34
27	Not-Stop .....	34
28	Akustisches Signal .....	34
29	Betriebsstunden-Abfrage .....	34
30	Datums- und Uhrzeit-Einstellung .....	34
31	Angezeigte Zentrifugations-Daten nach dem Einschalten .....	35
32	Sofortige Anzeige der Zentrifugations-Daten nach dem Einschalten .....	35
33	Schlüsselschalter .....	35
34	Programmverknüpfung (nur bei Zentrifuge mit Programmverknüpfung) .....	35
34.1	Programme verknüpfen .....	35
34.2	Programmverknüpfung ändern .....	35
34.3	Zentrifugationslauf mit Programmverknüpfung .....	36
34.4	Programmverknüpfung löschen .....	36
35	Kühlung .....	37
35.1	Standby-Kühlung .....	37
35.2	Vorkühlen des Rotors .....	37
36	Heizung .....	37
37	Relative Zentrifugalbeschleunigung (RCF) .....	37
38	Zentrifugation von Stoffen oder Stoffgemischen mit einer höheren Dichte als $1,2 \text{ kg/dm}^3$ .....	38
39	Rotorerkennung .....	38
40	Notentriegelung .....	38
41	Pflege und Wartung .....	39
41.1	Zentrifuge (Gehäuse, Deckel und Schleuderraum) .....	39
41.1.1	Oberflächenreinigung und -pflege .....	39
41.1.2	Oberflächendesinfektion .....	39
41.1.3	Entfernen radioaktiver Verunreinigungen .....	39
41.2	Rotoren und Zubehör .....	40
41.2.1	Reinigung und Pflege .....	40
41.2.2	Desinfektion .....	40
41.2.3	Entfernen radioaktiver Verunreinigungen .....	41
41.2.4	Tragzapfen .....	41
41.2.5	Rotoren und Zubehör mit begrenzter Verwendungsdauer .....	41
41.2.6	Berechnung der Anzahl der durchgeführten Laufzyklen .....	41
41.3	Autoklavieren .....	42
41.4	Zentrifugiergefäße .....	42

42	Störungen.....	43
43	Rücksendung von Geräten.....	44
44	Entsorgung.....	44
45	Anhang / Appendix.....	140
45.1	Rotoren und Zubehör / Rotors and accessories.....	140

## 1 Anwendung dieser Bedienungsanleitung

- Vor Benutzung der Zentrifuge ist die Bedienungsanleitung zu lesen und zu beachten.
- Die Bedienungsanleitung ist Teil des Gerätes. Sie muss stets griffbereit aufbewahrt werden.
- Wird das Gerät an einem anderen Ort aufgestellt, muss die Bedienungsanleitung mitgegeben werden.

## 2 Bedeutung der Symbole



Symbol am Gerät:  
Achtung, allgemeine Gefahrenstelle.



Symbol am Gerät:  
Bedienungsanleitung beachten.  
Dieses Symbol verweist darauf hin, dass der Anwender die bereitgestellte Bedienungsanleitung beachten muss.



Symbol in diesem Dokument:  
Achtung, allgemeine Gefahrenstelle.  
Dieses Symbol kennzeichnet sicherheitsrelevante Hinweise und deutet auf mögliche gefährliche Situationen hin.  
Das Nichtbeachten dieser Hinweise kann zu Sach- und Personenschäden führen.



Symbol am Gerät und in diesem Dokument:  
Warnung vor Biogefährdung.



Symbol am Gerät und in diesem Dokument:  
Warnung vor heißer Oberfläche.  
Das Nichtbeachten dieses Hinweises kann zu Sach- und Personenschäden führen.



Symbol am Gerät:  
Äquipotential: Steckverbinder (PA-Stecker) für Potentialausgleich (nur bei Zentrifuge mit PA-Stecker).



Symbol am Gerät:  
Schaltstellungen des Schlüsselschalters.



Symbol am Gerät:  
Optische Schnittstelle (nur bei Zentrifuge mit optischer Schnittstelle).



Symbol in diesem Dokument:  
Dieses Symbol deutet auf wichtige Sachverhalte hin.



Symbol am Gerät und in diesem Dokument:  
Symbol für die getrennte Sammlung von Elektro- und Elektronikgeräten, gemäß der Richtlinie 2012/19/EU.  
Verwendung in den Ländern der Europäischen Union sowie in Norwegen und der Schweiz. [EL10]



Symbol auf der Verpackung:  
Diese Seite oben.



Symbol auf der Verpackung:  
Die Transportverpackung muss innerhalb des angezeigten Luftfeuchtigkeitsbereichs (10% - 80%) gelagert, transportiert und gehandhabt werden.



Symbol auf der Verpackung:  
Die Versandverpackung muss innerhalb des angezeigten Temperaturbereichs (-20°C - +60°C) gelagert, transportiert und gehandhabt werden.





Symbol auf der Verpackung:

Die Transportverpackung muss von Regen ferngehalten werden und in trockener Umgebung gehalten werden.



Symbol auf der Verpackung:

Zerbrechlich, Vorsichtig behandeln.



Symbol auf der Verpackung:

Stapelbegrenzung. Höchste Anzahl identischer Packstücke, die auf das unterste Packstück gestapelt werden darf, wobei „n“ für die Anzahl der zulässigen Packstücke steht. Das unterste Packstück ist nicht in „n“ enthalten.

### 3 Bestimmungsgemäße Verwendung

Bei dem vorliegenden Gerät handelt es sich um eine Laborzentrifuge, die für medizinische Anwendungen geeignet ist.

Ihre ausschließliche therapeutische Zweckbestimmung besteht darin, Blut in Blutbeutelssystemen zu zentrifugieren. Die separierten Blutkomponenten werden von einem anderen Gerät (Separator) in entsprechende Satellitenbeutel überführt. Die so gewonnenen Einzelkomponenten werden dann für die Transfusion oder Autotransfusion eingesetzt.

Die Zentrifuge darf nur von Fachpersonal in Blutspendediensten oder Krankenhäusern betrieben werden.

Die Zentrifuge ist nur für die oben genannten Verwendungszwecke bestimmt.

Eine andere oder darüberhinausgehende Benutzung gilt als nicht bestimmungsgemäß. Für hieraus entstehende Schäden haftet die Firma Andreas Hettich GmbH & Co. KG nicht.

Zur bestimmungsgemäßen Verwendung gehört auch die Beachtung aller Hinweise aus der Bedienungsanleitung und die Einhaltung der Inspektions- und Wartungsintervalle.

### 4 Restrisiken

Das Gerät ist nach dem Stand der Technik und den anerkannten sicherheitstechnischen Regeln gebaut.

Bei unsachgemäßer Verwendung und Behandlung können Gefahren für Leib und Leben des Benutzers oder Dritter bzw. Beeinträchtigungen an dem Gerät oder an anderen Sachwerten entstehen.

Das Gerät ist nur für die bestimmungsgemäße Verwendung, und nur in sicherheitstechnisch einwandfreiem Zustand zu benutzen.

Störungen, die die Sicherheit beeinträchtigen können, sind umgehend zu beseitigen.

## 5 Technische Daten

Hersteller	Andreas Hettich GmbH & Co. KG D-78532 Tuttlingen			
Modell	ROTIXA 500 RS			
Basic UDI-DI	4050674010002Q2[LA13]			
Typ	4950, 4950-50		4950-70, 4950-80	
Netzspannung ( $\pm 10\%$ )	230-240 V ~	220 V ~	230-240 V ~	220 V ~
Netzfrequenz	50 Hz	60 Hz	50 Hz	60 Hz
Anschlusswert	3800 VA			
Stromaufnahme	16 A			
Kältemittel	R452A			
Kapazität max.	4 x 1000 ml			
zulässige Dichte	1.2 kg/dm <sup>3</sup>			
Drehzahl (RPM)	11500			
Beschleunigung (RCF)	18038			
Kinetische Energie	59620 Nm			
Prüfpflicht (DGUV Regel 100 – 500)	ja			
Umgebungsbedingungen (EN / IEC 61010-1)	<p>nur in Innenräumen bis zu 2000 m über Normal-Null 5°C bis 35°C maximale relative Luftfeuchte 80% für Temperaturen bis 31°C, linear abnehmend bis 50% relativer Luftfeuchte bei 40°C.</p>			
– Aufstellungsort				
– Höhe				
– Umgebungstemperatur				
– Luftfeuchtigkeit				
– Überspannungskategorie (IEC 60364-4-443)	II			
– Verschmutzungsgrad	2			
Geräteschutzklasse	I			
nicht für den Einsatz in explosionsgefährdeter Umgebung geeignet.				
EMV	EN / IEC 61326-1, Klasse B			
– Störaussendung, Störfestigkeit				
Geräuschpegel (rotorabhängig)	$\leq 65$ dB(A)		$\leq 63$ dB(A)	
Abmessungen	<p>650 mm 814 mm 973 mm</p>			
– Breite				
– Tiefe				
– Höhe	973 mm			
Gewicht	ca. 219 kg		ca. 233 kg	

Hersteller	Andreas Hettich GmbH & Co. KG D-78532 Tuttlingen	
Modell	ROTIXA 500 RS	
Basic UDI-DI	4050674010002Q2	
Typ	4950-08, 4950-58	4950-78, 4950-88
Netzspannung ( $\pm 10\%$ )	208 V ~	
Netzfrequenz	60 Hz	
Anschlusswert	3800 VA	
Stromaufnahme	18 A	
Kältemittel	R452A	
Kapazität max.	4 x 1000 ml	
zulässige Dichte	1.2 kg/dm <sup>3</sup>	
Drehzahl (RPM)	11500	
Beschleunigung (RCF)	18038	
Kinetische Energie	59620 Nm	
Prüfpflicht (DGUV Regel 100 – 500)	ja	
Umgebungsbedingungen (EN / IEC 61010-1)	<p>nur in Innenräumen bis zu 2000 m über Normal-Null 5°C bis 35°C maximale relative Luftfeuchte 80% für Temperaturen bis 31°C, linear abnehmend bis 50% relativer Luftfeuchte bei 40°C.</p>	
– Aufstellungsort		
– Höhe		
– Umgebungstemperatur		
– Luftfeuchtigkeit		
– Überspannungskategorie (IEC 60364-4-443)	II	
– Verschmutzungsgrad	2	
Geräteschutzklasse	I	
nicht für den Einsatz in explosionsgefährdeter Umgebung geeignet.		
EMV	FCC Class B	
– Störaussendung, Störfestigkeit		
Geräuschpegel (rotorabhängig)	$\leq 65$ dB(A)	$\leq 63$ dB(A)
Abmessungen		
– Breite	650 mm	
– Tiefe	814 mm	
– Höhe	973 mm	
Gewicht	ca. 225 kg	ca. 239 kg

## 6 Sicherheitshinweise



Werden nicht alle Hinweise in dieser Bedienungsanleitung befolgt, kann beim Hersteller kein Gewährleistungsanspruch geltend gemacht werden.



### Meldungen von schwerwiegenden Vorfällen mit dem Gerät

Bei schwerwiegenden Vorfällen mit dem Gerät, diese dem Hersteller und ggf. der zuständigen Behörde melden.



- Die Zentrifuge ist so aufzustellen, dass sie standsicher betrieben werden kann.
- Vor Benutzung der Zentrifuge unbedingt den Rotor auf festen Sitz prüfen.
- Während eines Zentrifugationslaufes dürfen sich gemäß EN / IEC 61010-2-020, in einem Sicherheitsbereich von 300 mm um die Zentrifuge herum, keine Personen, Gefahrstoffe und Gegenstände befinden.
- Rotoren, Gehänge und Zubehörteile, die starke Korrosionsspuren oder mechanische Schäden aufweisen, oder deren Verwendungsdauer abgelaufen ist, dürfen nicht mehr verwendet werden.
- Die Zentrifuge darf nicht mehr in Betrieb genommen werden, wenn der Schleuderraum sicherheitsrelevante Schäden aufweist.
- Bei Ausschwingrotoren müssen die Tragzapfen regelmäßig gefettet werden (Hettich-Schmierfett Nr. 4051), um ein gleichmäßiges Ausschwingen der Gehänge zu gewährleisten.
- Bei Zentrifugen ohne Temperaturregelung kann es bei erhöhter Raumtemperatur und/oder bei häufigem Gebrauch des Gerätes zur Erwärmung des Schleuderraums kommen. Eine temperaturbedingte Veränderung des Probenmaterials kann deshalb nicht ausgeschlossen werden.

- Vor Inbetriebnahme der Zentrifuge ist die Bedienungsanleitung zu lesen und zu beachten. Nur Personen, die die Bedienungsanleitung gelesen und verstanden haben, dürfen das Gerät bedienen.
- Neben der Bedienungsanleitung und den verbindlichen Regelungen der Unfallverhütung sind auch die anerkannten fachtechnischen Regeln für sicherheits- und fachgerechtes Arbeiten zu beachten. Die Bedienungsanleitung ist um Anweisungen aufgrund bestehender nationaler Vorschriften des Verwenderlandes zur Unfallverhütung und zum Umweltschutz zu ergänzen.
- Die Zentrifuge ist nach dem Stand der Technik gebaut und betriebssicher. Es können aber von ihr Gefahren für den Benutzer oder Dritte ausgehen, wenn sie nicht von geschultem Personal oder unsachgemäß oder zu nicht bestimmungsgemäßem Gebrauch eingesetzt wird.
- Die Zentrifuge darf während des Betriebs nicht bewegt oder angestoßen werden.
- Im Störfall bzw. bei der Notentriegelung nie in den sich drehenden Rotor greifen.
- Um Schäden durch Kondensat zu vermeiden, muss bei Wechsel von einem kalten in einen warmen Raum, die Zentrifuge entweder mindestens 3 Stunden im warmen Raum aufwärmen bevor sie an das Netz angeschlossen werden darf oder 30 Minuten im kalten Raum warmlaufen.
- Es dürfen nur die vom Hersteller für dieses Gerät zugelassenen Rotoren und das zugelassene Zubehör verwendet werden (siehe Kapitel "Anhang/Appendix, Rotoren und Zubehör/Rotors and accessories"). Bevor Zentrifugiergefäße verwendet werden, die nicht in Kapitel "Anhang/Appendix, Rotoren und Zubehör/Rotors and accessories" aufgeführt sind, hat sich der Benutzer beim Hersteller zu vergewissern, ob diese verwendet werden dürfen.
- Der Rotor der Zentrifuge darf nur entsprechend dem Kapitel "Beladen des Rotors" beladen werden.
- Bei der Zentrifugation mit maximaler Drehzahl darf die Dichte der Stoffe oder Stoffgemische  $1,2 \text{ kg/dm}^3$  nicht überschreiten.
- Zentrifugationen mit unzulässiger Unwucht sind nicht erlaubt.
- Die Zentrifuge darf nicht in explosionsgefährdeter Umgebung betrieben werden.
- Eine Zentrifugation mit:
  - brennbaren oder explosiven Materialien
  - Materialien, die chemisch mit hoher Energie miteinander reagieren ist verboten.

Bei Zentrifugation petrochemischer Proben gemäß Vorgaben des ASTM muss seitens des Anwenders eine Risikoabschätzung vorgenommen werden.

- Bei der Zentrifugation von gefährlichen Stoffen bzw. Stoffgemischen, die toxisch, radioaktiv oder mit pathogenen Mikroorganismen verseucht sind, sind durch den Benutzer geeignete Maßnahmen zu treffen. Es müssen grundsätzlich Zentrifugiergefäße mit speziellen Schraubverschlüssen für gefährliche Substanzen verwendet werden. Bei Materialien der Risikogruppe 3 und 4 ist zusätzlich zu den verschließbaren Zentrifugiergefäßen ein Bio-Sicherheitssystem zu verwenden (siehe Handbuch "Laboratory Bio-safety Manual" der Weltgesundheitsorganisation).  
Bei einem Bio-Sicherheitssystem verhindert eine Bioabdichtung (Dichtungsring) das Austreten von Tröpfchen und Aerosolen.  
Wird das Gehänge eines Bio-Sicherheitssystems ohne den Deckel verwendet, muss der Dichtungsring vom Gehänge entfernt werden, um eine Beschädigung des Dichtungsringes während des Zentrifugationslaufes zu vermeiden.  
Beschädigte Bio-Sicherheitssysteme sind nicht mehr mikrobiologisch dicht.  
Ohne Verwendung eines Bio-Sicherheitssystems ist eine Zentrifuge im Sinne der Norm EN / IEC 61010-2-020 nicht mikrobiologisch dicht.  
Beim Schließen eines Bio-Sicherheitssystems sind die Anweisungen in Kapitel "Verschließen von Bio-Sicherheitssystemen" zu befolgen.  
Lieferbare Bio-Sicherheitssysteme siehe Kapitel "Anhang/Appendix, Rotoren und Zubehör/Rotors and accessories". Im Zweifelsfall sind entsprechende Informationen beim Hersteller einzuholen.
- Der Betrieb der Zentrifuge mit stark korrodierenden Stoffen, welche die mechanische Festigkeit von Rotoren, Gehängen und Zubehörteilen beeinträchtigen können, ist nicht erlaubt.
- Reparaturen dürfen nur von einer vom Hersteller autorisierten Person ausgeführt werden.
- Es dürfen nur Originalersatzteile und zugelassenes Originalzubehör der Firma Andreas Hettich GmbH & Co. KG verwendet werden.
- Es gelten die folgenden Sicherheitsbestimmungen:  
EN / IEC 61010-1 und EN / IEC 61010-2-020 sowie deren nationalen Abweichungen.
- Die Sicherheit und Zuverlässigkeit der Zentrifuge ist nur dann gewährleistet, wenn:
  - die Zentrifuge nach der Bedienungsanleitung betrieben wird.
  - die elektrische Installation, am Aufstellungsort der Zentrifuge, den Anforderungen von EN / IEC Festlegungen entspricht.
- Die Erfüllung länderspezifischer Vorgaben zur Arbeitssicherheit bezüglich des Einsatzes von Laborzentrifugen an den vom Betreiber dafür vorgesehenen Arbeitsplätzen liegt im Verantwortungsbereich des Betreibers.

## 7 Auspacken und Aufstellen der Zentrifuge

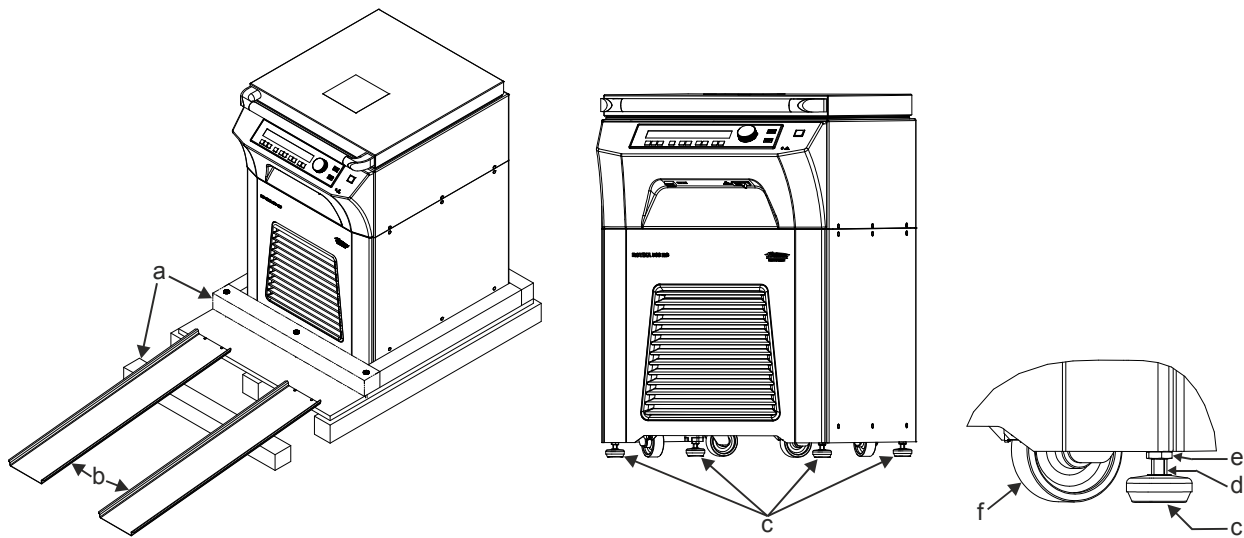

- Die Verpackung entfernen.
- Den vorderen Holzbalken (a) entfernen.
- Die Metallschienen (b) mit je zwei Nägeln an der Holzpalette befestigen.
- Den vorderen Holzbalken (a) unter die Metallschienen (b) schieben, um diese zu stützen.
- Den mitgelieferten Gabelschlüssel (Größe 10 mm) an den Flächen (d) ansetzen und die Gerätefüße (c) soweit wie möglich nach oben drehen.
- Die Zentrifuge über die Metallschienen (b) vorsichtig von der Holzpalette herunterrollen.
- Die Zentrifuge an ihren Aufstellungsort schieben.
- Den mitgelieferten Gabelschlüssel (Größe 10 mm) an den Flächen (d) ansetzen und die Gerätefüße (c) soweit nach unten drehen, bis die Lenkrollen (f) keinen Kontakt mehr zum Boden haben.
- Durch Drehen der Gerätefüße (c) die Zentrifuge waagrecht ausrichten.
- Die Sechskantmutter (e) mit dem mitgelieferten Gabelschlüssel (Größe 19 mm) nach oben drehen und festziehen, um die Position der Gerätefüße (c) zu sichern.

## 8 Lieferumfang

- 1 Netzkabel
- 1 Einmaulschlüssel, Größe 10 mm (zum Drehen der Gerätefüße)
- 1 Doppelpmaulschlüssel, Größe 17/19 mm (zum Festziehen der Sechskantmutter an den Gerätefüßen)
- 1 Vierkantschlüssel (zum Ein- und Ausbauen des Rotors)
- 1 Sechskant-Stiftschlüssel (zum Notentriegeln des Deckels)
- 1 Schmierfett für Tragzapfen
- 1 Tuben-Entleerer
- 10 Abdeckkappen (Ø12 mm) für Torx-Schraubenköpfe Größe T20
- 1 Bedienungsanleitung
- 3 Programm-Datenblätter

### Nur für Deutschland:

- 1 IQ (Installation Qualification)
- 1 Prüfbuch

Rotor(en) und das entsprechende Zubehör werden je nach Bestellung mitgeliefert.

## 9 Transport und Lagerung

### 9.1 Transport

Beim Transport des Gerätes und des Zubehörs müssen folgende Umgebungsbedingungen eingehalten werden:

- Umgebungstemperatur:  $-20^{\circ}\text{C}$  bis  $+60^{\circ}\text{C}$
- Relative Luftfeuchtigkeit: 10% bis 80%, nicht kondensierend

### 9.2 Lagerung



Das Gerät und das Zubehör dürfen nur in geschlossenen und trockenen Räumen gelagert werden.

Bei der Lagerung des Gerätes und des Zubehörs müssen folgende Umgebungsbedingungen eingehalten werden:

- Umgebungstemperatur:  $-20^{\circ}\text{C}$  bis  $+60^{\circ}\text{C}$
- Relative Luftfeuchtigkeit: 10% bis 80%, nicht kondensierend

## 10 Inbetriebnahme

- Wenn das Gerät in der Gebäudeinstallation zusätzlich mit einem Fehlerstrom-Schutzschalter abgesichert wird, muss ein Fehlerstrom-Schutzschalter vom Typ B verwendet werden. Bei Verwendung eines anderen Typs kann es vorkommen, dass der Fehlerstrom-Schutzschalter entweder das Gerät nicht abschaltet, wenn ein Fehler am Gerät vorliegt oder dass er das Gerät abschaltet, obwohl kein Fehler am Gerät vorliegt.
- Bei den Typen 4950-08, 4950-58, 4950-78 und 4950-88 handelt es sich um festangeschlossene Geräte. Bei festangeschlossenen Geräten muss, gemäß der Laborgerätenorm EN / IEC 61010-1, in der Gebäudeinstallation ein Schalter zur Trennung der Netzversorgung des Geräts angebracht sein. Der Schalter muss sich in der Nähe des Geräts befinden, für den Benutzer leicht erreichbar und als Trennvorrichtung für dieses Gerät gekennzeichnet sein. Der Schalter muss gegen ein Wiedereinschalten gesichert werden können[LA38].
- Die Typen 4950-70, 4950-78, 4950-80 und 4950-88 dürfen nur von autorisiertem Fachpersonal installiert werden.



Diese Geräte müssen gemäß den beigefügten Aufstellungs- und Installationshinweisen AH4950DE installiert werden.

- **Die Zentrifuge an einem geeigneten Platz standsicher aufstellen und nivellieren. Bei der Aufstellung ist der geforderte Sicherheitsbereich gemäß EN / IEC 61010-2-020, von 300 mm um die Zentrifuge herum, einzuhalten.**



**Während eines Zentrifugationslaufes dürfen sich gemäß EN / IEC 61010-2-020, in einem Sicherheitsbereich von 300 mm um die Zentrifuge herum, keine Personen, Gefahrstoffe und Gegenstände befinden.**

- Lüftungsöffnungen dürfen nicht zugestellt werden.  
Es muss ein Abstand von 300 mm zu den Lüftungsschlitzen und Lüftungsöffnungen der Zentrifuge eingehalten werden.
- Zentrifuge mit PA-Stecker:  
Bei Bedarf den PA-Stecker an der Rückseite des Gerätes mit einem zusätzlichen medizinischen Potential-Ausgleich-System verbinden.
- Zentrifuge mit optischer Schnittstelle:  
Die optische Schnittstelle der Zentrifuge mit einem Lichtleitkabel (nicht im Lieferumfang enthalten) an den PC anschließen.
- Prüfen, ob die Netzspannung mit der Angabe auf dem Typenschild übereinstimmt.
- Die Zentrifuge mit dem Netzkabel an eine genormte Netzsteckdose anschließen. Anschlusswert siehe Kapitel "Technische Daten".
- Den Netzschalter einschalten. Schalterstellung "I".  
Es erfolgt die Anzeige:  
1. Typ der Zentrifuge, 2. der zuletzt durch die Rotorerkennung erkannte Rotorcode und die maximale Drehzahl des Rotors (n-max-Rotor), 3. die Programmversion, 4. **⚡ OPEN ⚡ OEFFNEN**.
- Den Deckel öffnen.  
Die Zentrifugierdaten des zuletzt benutzten Programms oder des Programms 1 werden angezeigt.

## 11 Schnittstelle (nur bei Zentrifuge mit Schnittstelle)

Optional kann das Gerät mit einer optischen Schnittstelle ausgerüstet werden.

Die optische Schnittstelle ist mit dem Symbol  gekennzeichnet.

Über diese Schnittstelle kann die Zentrifuge gesteuert und Daten abgefragt werden.

## 12 Deckel öffnen und schließen

### 12.1 Deckel öffnen





Der Deckel lässt sich nur öffnen, wenn die Zentrifuge eingeschaltet ist und der Rotor stillsteht. Sollte dies nicht möglich sein, siehe Kapitel "Notentriegelung".

- Die Taste  an der Frontblende drücken. Der Deckel entriegelt motorisch, die Beleuchtung in der Taste  erlischt und in der Anzeige ändert sich das Symbol  zu Symbol .

### 12.2 Deckel schließen



Mit den Fingern nicht zwischen Deckel und Gehäuse greifen.  
Den Deckel nicht zuschlagen.

- Den Deckel auflegen und an dem Rohr-Griff leicht niederdrücken. Die Verriegelung erfolgt motorisch. Die Taste  leuchtet auf und in der Anzeige ändert sich das Symbol  zu Symbol .

## 13 Ein- und Ausbau des Rotors

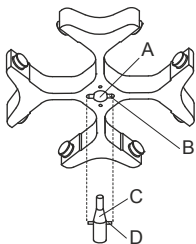

- Die Motorwelle (C) und die Bohrung des Rotors (A) reinigen und anschließend die Motorwelle leicht einfetten. Schmutzpartikel zwischen der Motorwelle und dem Rotor verhindern einen einwandfreien Sitz des Rotors und verursachen einen unruhigen Lauf.
- Den Rotor vertikal auf die Motorwelle aufsetzen. Der Mitnehmer der Motorwelle (D) muss sich in der Nut des Rotors (B) befinden. Auf dem Rotor ist die Ausrichtung der Nut gekennzeichnet.
- Die Spannmutter des Rotors mit dem mitgelieferten Schlüssel durch Drehen im Uhrzeigersinn anziehen.
- Den Rotor auf festen Sitz prüfen.



Um einen festen Sitz des Rotors zu gewährleisten, muss die Mutter des Rotors handfest angezogen werden.

- Lösen des Rotors: Die Spannmutter durch Drehen entgegen dem Uhrzeigersinn lösen und bis zum Abhebe-Druckpunkt drehen. Nach Überwindung des Abhebe-Druckpunkts löst sich der Rotor vom Konus der Motorwelle. Die Spannmutter drehen, bis sich der Rotor von der Motorwelle abheben lässt.



## 14 Gehänge in den Rotor einsetzen und herausnehmen

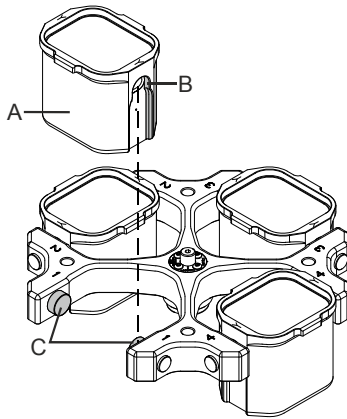

Bei Ausschwingrotoren müssen alle Plätze des Rotors mit **gleichen** Gehängen besetzt sein.



Bestimmte Gehänge sind mit der Nummer des Rotorplatzes gekennzeichnet. Diese Gehänge dürfen nur in den entsprechenden Platz des Rotors eingesetzt werden.

Gehänge die mit einer Set-Nummer gekennzeichnet sind, z. B. S001/4, dürfen nur im Set verwendet werden.

### Gehänge in den Rotor einsetzen:

- Den Rotor auf festen Sitz prüfen.
- Die Tragzapfen (C) einfetten (Hettich-Schmierfett Nr 4051).
- Die Gehänge (A) in den Rotor einsetzen. Dabei beachten, dass sich die Tragzapfen (C) in der Nuten (B) der Gehänge befinden.
- Die Gehänge bis zum Anschlag nach unten schieben.

### Gehänge aus dem Rotor herausnehmen:

- Die Gehänge (A) senkrecht nach oben aus dem Rotor herausziehen.

## 15 Adapter in die Gehänge einsetzen und herausnehmen

### Adapter in die Gehänge einsetzen:

- Die Adapter (A) waagrecht in die Gehänge (B) einsetzen.

### Adapter aus den Gehängen herausnehmen:

- Die Adapter (A) nach oben aus den Gehängen (B) herausnehmen.

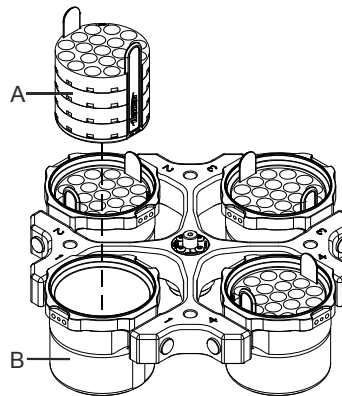
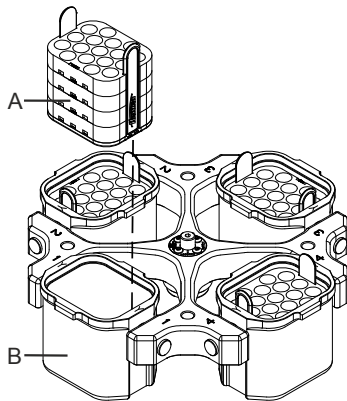

## 16 Beladen des Rotors



Standard-Zentrifugiergefäße aus Glas sind belastbar bis RZB 4000 (DIN 58970 Teil 2).

- Den Rotor auf festen Sitz prüfen.
- Bei Ausschwingrotoren müssen alle Plätze des Rotors mit **gleichen** Gehängen besetzt sein. Bestimmte Gehänge sind mit der Nummer des Rotorplatzes gekennzeichnet. Diese Gehänge dürfen nur in den entsprechenden Platz des Rotors eingesetzt werden. Gehänge die mit einer Set-Nummer gekennzeichnet sind, z. B. S001/4, dürfen nur im Set verwendet werden.
- Die Rotoren und Gehänge dürfen nur symmetrisch beladen werden. Die Zentrifugiergefäße müssen gleichmäßig auf alle Plätze des Rotors verteilt werden. Zugelassene Kombinationen siehe Kapitel "Anhang/Appendix, Rotoren und Zubehör/Rotors and accessories". Bei Winkelrotoren müssen alle möglichen Plätze des Rotors beladen werden, siehe Kapitel "Anhang/Appendix, Rotoren und Zubehör/Rotors and accessories".

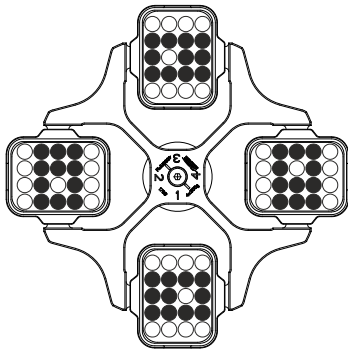

Rotor ist symmetrisch beladen

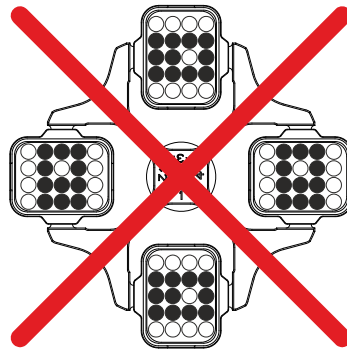

**Nicht zulässig!**  
Rotor ist unsymmetrisch beladen

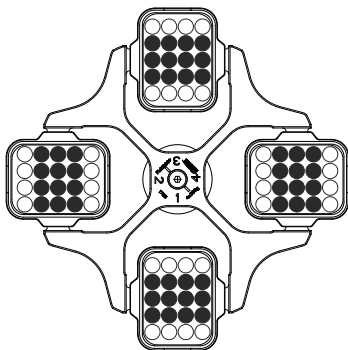

Rotor ist gleichmäßig beladen

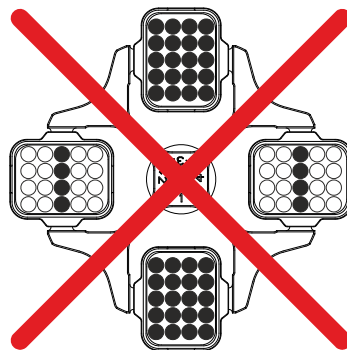

**Nicht zulässig!**  
Rotor ist ungleichmäßig beladen

- Auf bestimmten Gehängen ist das Gewicht der maximalen Beladung oder das Gewicht der maximalen Beladung und das maximale Gewicht des komplett bestückten Gehänges angegeben. Diese Gewichte dürfen nicht überschritten werden. Im Ausnahmefall siehe Kapitel "Zentrifugation von Stoffen oder Stoffgemischen mit einer höheren Dichte als  $1,2 \text{ kg/dm}^3$ ". Die Gewichtsangabe der maximalen Beladung umfasst das Gesamtgewicht von Adapter, Zentrifugiergefäß und Inhalt.
- Bei Behältern mit Gummieinlagen muss sich unter den Zentrifugiergefäßen immer die gleiche Anzahl von Gummieinlagen befinden.
- Die Zentrifugiergefäße dürfen nur außerhalb der Zentrifuge befüllt werden.

- Die vom Hersteller angegebene maximale Füllmenge der Zentrifugiergefäße darf nicht überschritten werden. Bei Winkelrotoren dürfen die Zentrifugiergefäße nur soweit befüllt werden, dass während des Zentrifugationslaufes keine Flüssigkeit aus den Gefäßen herausgeschleudert werden kann.

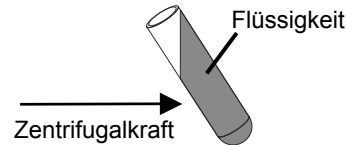

- Beim Beladen der Winkelrotoren darf keine Flüssigkeit in die Winkelrotoren und in den Schleuderraum gelangen.
- Beim Beladen der Gehänge der Ausschwingrotoren und beim Ausschwingen der Gehänge während des Zentrifugationslaufes darf keine Flüssigkeit in die Gehänge und in den Schleuderraum gelangen.
- Um die Gewichtsunterschiede innerhalb der Zentrifugiergefäße möglichst gering zu halten, ist auf eine gleichmäßige Füllhöhe in den Gefäßen zu achten.

## 17 Verschließen von Bio-Sicherheitssystemen



Um Dichtigkeit zu gewährleisten, muss der Deckel eines Bio-Sicherheitssystems fest verschlossen werden.

Um ein Verdrehen des Dichtungsringes während dem Öffnen und Schließen des Deckels zu vermeiden, muss der Dichtungsring mit einem Gummi-Pflegemittel leicht eingerieben werden.

Lieferbare Bio-Sicherheitssysteme siehe Kapitel "Anhang/Appendix, Rotoren und Zubehör/Rotors and accessories". Im Zweifelsfall sind entsprechende Informationen beim Hersteller einzuholen.

### Deckel mit Schraubverschluss und Bohrung im Drehgriff

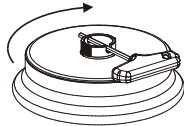

- Den Deckel mittig auf den Rotor aufsetzen.
- Den mitgelieferten Schlüssel durch die Bohrung im Drehgriff stecken und durch Drehen im Uhrzeigersinn den Deckel fest verschließen.

### Deckel mit Schraubverschluss

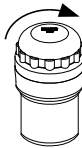

- Den Deckel auf das Gehänge aufsetzen.
- Den Deckel von Hand, durch Drehen im Uhrzeigersinn, fest verschließen.

## 18 Packanweisung HettLiner

### 18.1 Packen vor der Zentrifugation

Hinweis: Darauf achten, dass der Kunststoffeinsatz beim Be- und Entladen der Einsätze nicht kippen kann (Beladehilfe 4509 verwenden).

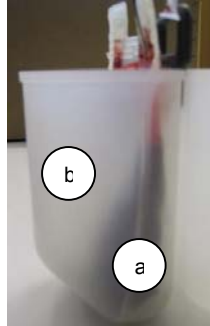
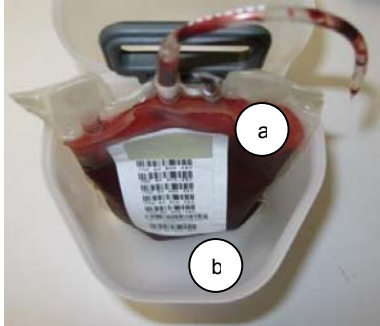

- Blutbeutel (a) in den Einsatz (b) einsetzen.

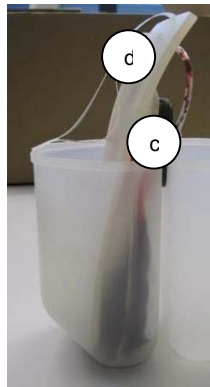
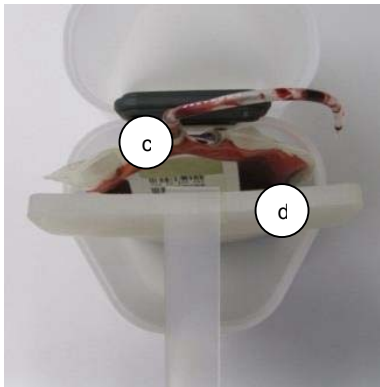

- Blutbeutel an den Anschlüssen (c) festhalten und die Stützplatte (d) an der äußeren Seite des Blutbeutels von oben nach unten in den Einsatz schieben.

- Darauf achten, dass die untere Kante der Stützplatte möglichst vollständig auf dem Boden aufsteht.

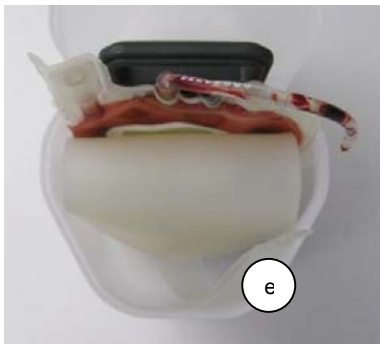

- Die Stützplatte nach außen umklappen und soweit nach unten drücken, bis sich die umgeschlagene Kante der Stützplatte auf Höhe des Flüssigkeitsniveaus des Blutbeutels befindet.
- Dabei muss die Lage der Schlaufe (e) beachtet werden, damit diese nach der Zentrifugation auch erreicht werden kann!
- Die obere Kante der Stützplatte darf wegen Klemmgefahr mit den Rotorarmen beim Zentrifugieren nicht zu weit aus dem Einsatz hinausragen!

- Wenn vorhanden, leere/n Satellitenbeutel falten und je nach entsprechendem Zubehör und Füllvolumen des Blutbeutels unterschiedlich packen.  
Es ist vorteilhaft die Satellitenbeutel zu falten und außen zwischen die umgeklappte Stützplatte und die Außenwand des Einsatzes zu packen.  
→ Darauf achten, dass die Silikonplatte dabei nicht verrutscht!  
→ Gegebenenfalls kann beim Packen des Satellitenbeutels die Silikonplatte an der Schlaufe festgehalten und somit gegengehalten werden.  
→ Lage der Schlaufe muss danach überprüft werden!
- Anschlüsse so über die Stützplatte legen, dass die Ventile nicht brechen können.  
Darauf achten, dass die Schläuche nicht aus dem Einsatz herausragen!

→ Über den Einsatzrand herausragende Schlauchstücke zwischen der umgeklappten Stützplatte und der Einsatzwand verstauen.

- Ausgleichsgewichte sollten, wenn benötigt, zwischen die umgeklappte Stützplatte und die Becherwand gelegt werden.

## **18.2 Entpacken nach der Zentrifugation**

- Satellitenbeutel aus dem Einsatz ziehen und währenddessen die Silikonplatte mit einer Hand fixieren.
- Den umgeklappten Teil der Stützplatte an der dafür vorgesehenen Schlaufe langsam herausziehen!  
→ Achtung: Stützplatte kontrolliert in ihre ursprüngliche Form zurückführen!  
→ Umgeklappter Teil der Stützplatte kann zurückspringen und Blutkomponenten vermischen.
- Den verbliebenen Blutbeutel wahlweise zusammen mit der Stützplatte oder nach Entfernen der Stützplatte aus dem Einsatz nehmen!

## 19 Bedien- und Anzeigeelemente

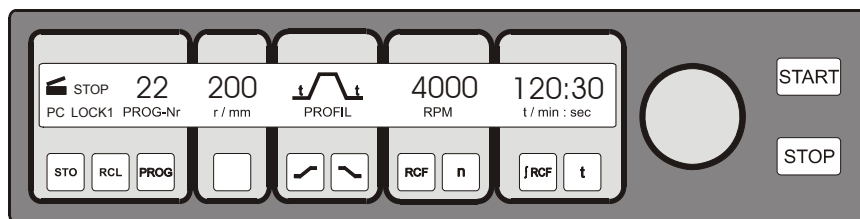

### 19.1 Status-Symbole



Deckel geöffnet.



Deckel geschlossen.



Rotationsanzeige. Die Anzeige erfolgt während des Zentrifugationslaufes, solange der Rotor dreht.

#### STOP

Zentrifugationslauf gestoppt oder beendet. Anzeige nach Beendigung des Zentrifugationslaufes, solange der Rotor dreht. Nach einem Not-Stop blinkt die Anzeige.

#### LOCK 1, LOCK 2

Schaltstellung des Schlüsselschalters.

#### LOCK 4, LOCK 5

Programmverriegelung bei Serieller Kommunikation (nur bei Zentrifuge mit serieller Kommunikation).

#### PC, ~~PE~~

Serielle Kommunikation (nur bei Zentrifuge mit serieller Kommunikation).

Bedienfehler bzw. auftretende Störungen werden im Display symbolisiert (siehe Kapitel "Störungen").

### 19.2 Drehknopf



Zum Einstellen der einzelnen Parameter.

Drehen entgegen dem Uhrzeigersinn erniedrigt den Wert. Drehen im Uhrzeigersinn erhöht den Wert.

### 19.3 Tasten und Einstellmöglichkeiten



Laufzeit, Parameter t/min:sec

1. Parameter t/min: Einstellbar von 1 - 999 min, in 1 min-Schritten.
2. Parameter t/ :sec Einstellbar von 1 - 59 s, in 1 Sekunden-Schritten.
3. Dauerlauf "---:--"



Abfrage des Integral RCF, Parameter  $\int$ RCF.



1. Drehzahl, Parameter RPM

Einstellbar ist ein Zahlenwert von 50 RPM bis zur maximalen Drehzahl des Rotors (n-max-Rotor). Maximale Drehzahl des Rotors siehe Kapitel "Anhang/Appendix, Rotoren und Zubehör/Rotors and accessories". Einstellbar in 10er Schritten.

2. Abfrage der maximalen Drehzahl des Rotors, Parameter n-max-Rotor.



1. Relative Zentrifugalbeschleunigung, Parameter RCF/RZB

Einstellbar ist ein Zahlenwert, der eine Drehzahl zwischen 50 RPM und der maximalen Drehzahl des Rotors (n-max-Rotor) ergibt. Einstellbar in 1er Schritten.

2. Abfrage der maximalen RCF des Rotors, Parameter RCF-max-Rotor.



Anlauf-Parameter

1. Anlaufstufen, Parameter  $\curvearrowright$ <sub>1-9</sub>. Stufe 9 = kürzeste Anlaufzeit, ... Stufe 1 = längste Anlaufzeit.

2. Anlaufzeit, Parameter  $\curvearrowright$ <sub>min:sec</sub>. Der einstellbare Zeitbereich ist von der eingestellten Drehzahl abhängig.



Auslauf-Parameter

1. Bremsstufen, Parameter  $\curvearrowleft$ <sub>0-9</sub>. R = Lineare Bremskurve, B = ähnlich einer exponentiellen Bremskurve. Stufe R9, B9 = kurze Auslaufzeit, ... Stufe R1, B1 = lange Auslaufzeit, Stufe R0 = ungebremster Auslauf.

2. Auslaufzeit, Parameter  $\curvearrowleft$ <sub>min:sec</sub>. Der einstellbare Zeitbereich ist von der eingestellten Drehzahl abhängig.

3. Bremsabschaltungs-Drehzahl, Parameter n<sup>(c)</sup>/RPM

Nach Erreichen dieser Drehzahl erfolgt der ungebremste Auslauf.



1. Temperatur-Sollwert, Parameter T/°C. Einstellbar von -20°C bis +40°C, in 1°C-Schritten (bei Option Heizen/Kühlen von -20°C bis +60°C einstellbar). Die tiefste erreichbare Temperatur ist rotorabhängig (siehe Kapitel "Anhang/Appendix, Rotoren und Zubehör/Rotors and accessories").

2. Zentrifugierradius, Parameter r/mm. Eingabe in mm. Zentrifugierradius siehe Kapitel "Anhang/Appendix, Rotoren und Zubehör/Rotors and accessories".



- |       |                                                                                                                                                                                                                                                                                                                 |
|-------|-----------------------------------------------------------------------------------------------------------------------------------------------------------------------------------------------------------------------------------------------------------------------------------------------------------------|
| START | 1. Zentrifugationslauf starten. Die Rotationsanzeige  erfolgt.<br>2. Übernahme von Änderungen während des Zentrifugationslaufes.                                                                                               |
| STOP  | Zentrifugationslauf beenden.<br>Der Rotor läuft mit dem vorgewählten Auslauf-Parameter aus. Zweimaliges Drücken der Taste löst den Not-Stop aus.                                                                                                                                                                |
| PROG  | Programmplatz anwählen, Parameter PROG-Nr.                                                                                                                                                                                                                                                                      |
| RCL   | Abrufen von Programmen.                                                                                                                                                                                                                                                                                         |
| STO   | Speichern von Programmen.<br>89 Programme können gespeichert werden (Programmplätze 1 bis 89). Hinweis: Die Programmplätze "----" und 90 bis 99 dienen als automatischer Zwischenspeicher (siehe Kapitel "Automatischer Zwischenspeicher"). Auf diese Programmplätze können keine Programme gespeichert werden. |

## 20 Zentrifugations-Parameter eingeben

 Die Eingabe eines Parameters ist nur möglich, wenn das Eingabefeld invers (dunkel hinterlegt) angezeigt wird. Ein inverses Eingabefeld erlischt automatisch nach 10 Sekunden.

### 20.1 Laufzeit



#### 20.1.1 Zeitvorwahl

- Die Taste  so oft drücken, bis der Parameter t/min: oder t/:sec angezeigt wird. Das Eingabefeld wird invers angezeigt.
- Mit dem Drehknopf  den gewünschten Wert einstellen.



#### 20.1.2 Dauerlauf

- Die Parameter t/min: und t/:sec nacheinander anwählen (siehe Kapitel "Zeitvorwahl"), und beide mit dem Drehknopf  auf Null stellen. Im Eingabefeld wird "---:--" angezeigt.

### 20.2 Drehzahl (RPM)

- Die Taste  so oft drücken, bis der Parameter RPM angezeigt und das Eingabefeld invers angezeigt wird.
- Mit dem Drehknopf  den gewünschten Wert einstellen.

### 20.3 Relative Zentrifugalbeschleunigung (RCF/RZB)

- Die Taste  so oft drücken, bis der Parameter RCF/RZB angezeigt und das Eingabefeld invers angezeigt wird.
- Mit dem Drehknopf  den gewünschten Wert einstellen.

Während der Einstellung blinkt die Anzeige des Zentrifugerradius.

### 20.4 An- und Auslauf-Parameter





Die eingestellten An- und Auslauf-Parameter werden angezeigt.





x: 1-9 = Anlaufstufe, t = Anlaufzeit

y: R1-R9, B1-B9 = Bremsstufe, R0 = ungebremster Auslauf, t = Auslaufzeit, n<sup>(\*)</sup> = Bremsabschaltungs-Drehzahl

#### 20.4.1 Anlaufstufe



- Die Taste  so oft drücken, bis der Parameter <sub>1-9</sub> oder  angezeigt wird. Das Eingabefeld wird invers angezeigt.
- Mit dem Drehknopf  die gewünschte Stufe einstellen.

#### 20.4.2 Anlaufzeit

- Die Taste  so oft drücken, bis der Parameter <sub>min:sec</sub> angezeigt wird. Das Eingabefeld wird invers angezeigt.
- Mit dem Drehknopf  den gewünschten Wert einstellen.

Wird eine Anlaufzeit eingestellt die länger als die Laufzeit ist, so endet der Zentrifugationslauf bevor die eingestellte Drehzahl erreicht wird.

### 20.4.3 Bremsstufe

- Die Taste  so oft drücken, bis der Parameter  $\backslash_{0-9}$  oder  $\backslash_{\downarrow}$  angezeigt wird. Das Eingabefeld wird invers angezeigt.
- Mit dem Drehknopf  die gewünschte Stufe einstellen.



B-Bremsstufen können nur bei speziellen Rotoren eingestellt werden.

### 20.4.4 Auslaufzeit

Ist eine Bremsabschaltungs-Drehzahl eingestellt, so ist keine Auslaufzeit einstellbar.



- Die Taste  so oft drücken, bis der Parameter  $\backslash_{\text{min:sec}}$  angezeigt wird. Das Eingabefeld wird invers angezeigt.
- Mit dem Drehknopf  den gewünschten Wert einstellen.

### 20.4.5 Bremsabschaltungs-Drehzahl

- Die Taste  so oft drücken, bis der Parameter  $n^{(r)}/\text{RPM}$  angezeigt wird. Das Eingabefeld wird invers angezeigt.
- Mit dem Drehknopf  den gewünschten Wert einstellen.



## 20.5 Radius/Temperatur

### 20.5.1 Radius

- Die Taste  so oft drücken, bis der Parameter  $r/\text{mm}$  angezeigt und das Eingabefeld invers angezeigt wird.
- Mit dem Drehknopf  den gewünschten Wert einstellen.

Durch Verändern des Radius passt sich der Wert der RCF/RZB automatisch an, dies wird durch Blinken angezeigt.

### 20.5.2 Temperatur





- Die Taste  so oft drücken, bis der Parameter  $T/^{\circ}\text{C}$  angezeigt und das Eingabefeld invers angezeigt wird.
- Mit dem Drehknopf  den gewünschten Wert einstellen.

## 20.6 Automatischer Zwischenspeicher



Der Zwischenspeicher umfasst die Programmplätze "----" und 90 bis 99. Nach jedem Start eines Zentrifugationslaufes werden geänderte Zentrifugations-Daten automatisch auf Programmplatz "----" gespeichert. Die geänderten Zentrifugations-Daten, der letzten 11 Zentrifugationsläufe, sind im Zwischenspeicher gespeichert und können abgerufen werden (siehe Kapitel "Programm-Abwurf").

## 21 Programmierung

### 21.1 Programm-Eingabe / -Änderung

- Die gewünschten Parameter einstellen (siehe Kapitel "Zentrifugations-Parameter eingeben").
- Die Taste  drücken, um den Parameter PROG-Nr anzuwählen. Das Eingabefeld wird invers angezeigt.
- Mit dem Drehknopf  den gewünschten Programmplatz einstellen.  
Blinkt die Anzeige des Programmplatzes, so ist dieser Programmplatz bereits mit Zentrifugations-Daten belegt. In diesem Fall einen freien Programmplatz einstellen, oder durch Fortfahren die Zentrifugations-Daten überschreiben.
- Die Taste  1x drücken, um die Einstellungen auf dem gewünschten Programmplatz zu speichern.  
Die Taste  2x drücken, um bereits gespeicherte Zentrifugations-Daten zu überschreiben.

### 21.2 Programm-Abwurf

- Die Taste  drücken, um den Parameter PROG-Nr anzuwählen. Das Eingabefeld wird invers angezeigt.
- Mit dem Drehknopf  den gewünschten Programmplatz einstellen.
- Die Taste  drücken. Die Zentrifugations-Daten des angewählten Programmplatzes werden angezeigt.



## 22 Zentrifugation



Während eines Zentrifugationslaufes dürfen sich gemäß EN / IEC 61010-2-020, in einem Sicherheitsbereich von 300 mm um die Zentrifuge herum, keine Personen, Gefahrstoffe und Gegenstände befinden.



Wird der zulässige Gewichtsunterschied innerhalb der Beladung des Rotors überschritten, schaltet der Antrieb während des Anlaufs ab und **IMBALANCE / UNWUCHT** wird angezeigt.

Ist die Drehzahl im angewählten Programm höher als die maximale Drehzahl des Rotors (n-max-Rotor), kann kein Zentrifugationslauf gestartet werden. Es wird **N > ROTOR MAX 96** angezeigt (siehe Kapitel "Störungen").

Ein Zentrifugationslauf kann jederzeit durch Drücken der Taste **STOP** abgebrochen werden.

Mit den Tasten **[RPM]** und **[RCF]** kann jederzeit zwischen der RPM- und RCF-Anzeige umgeschaltet werden. Wird mit der RCF-Anzeige gearbeitet, ist die Eingabe des Zentrifugerradius notwendig.

Wird **OPEN** / **OEFFNEN** angezeigt, so ist eine weitere Bedienung der Zentrifuge erst nach einmaligem Öffnen des Deckels möglich.

Wird **R xx n-max xxxxx** angezeigt, so hat kein Zentrifugationslauf stattgefunden, weil zuvor der Rotor gewechselt wurde, siehe Kapitel "Rotor-Erkennung".

- Den Netzschalter einschalten. Schalterstellung I.
- Den Rotor beladen und den Zentrifugendeckel schließen.

### 22.1 Zentrifugation mit Zeitvorwahl

- Zeit einstellen oder ein Programm mit Zeitvorwahl abrufen (siehe Kapitel "Zentrifugations-Parameter eingeben" oder "Programm-Abwurf").
- Die Taste **START** drücken. Die Rotationsanzeige erfolgt solange der Rotor dreht.
- Nach Ablauf der Zeit oder bei Abbruch des Zentrifugationslaufes durch Drücken der Taste **STOP**, erfolgt der Auslauf mit dem angewählten Auslauf-Parameter. Nach Stillstand des Rotors blinkt das Symbol in der Anzeige, bis der Deckel geöffnet wird.

Während des Zentrifugationslaufes werden die Drehzahl des Rotors oder der RCF-Wert, die Temperatur im Schleuderraum, und die verbleibende Zeit angezeigt.

### 22.2 Dauerlauf

- Symbol einstellen oder ein Dauerlauf-Programm abrufen (siehe Kapitel "Zentrifugations-Parameter eingeben" oder "Programm-Abwurf").
- Die Taste **START** drücken. Die Rotationsanzeige erfolgt solange der Rotor dreht. Die Zeitzählung beginnt bei 00:00.
- Die Taste **STOP** drücken, um den Zentrifugationslauf zu beenden. Der Auslauf erfolgt mit dem angewählten Auslauf-Parameter. Nach Stillstand des Rotors blinkt das Symbol in der Anzeige, bis der Deckel geöffnet wird.

Während des Zentrifugationslaufes werden die Drehzahl des Rotors oder der RCF-Wert, die Temperatur im Schleuderraum, und die gelaufene Zeit angezeigt.

## 23 Einstellungen während des Zentrifugationslaufes ändern

Die Laufzeit, die Drehzahl, die Relative Zentrifugalbeschleunigung (RCF/RZB), die Anlauf- und Auslauf-Parameter sowie die Temperatur können während des Zentrifugationslaufes verändert werden.

Die Parameter können nur einzeln und nacheinander verändert werden.

- Den gewünschten Parameter anwählen und mit dem Drehknopf den Wert verändern (siehe Kapitel "Zentrifugations-Parameter eingeben").
- Die Taste **START** drücken. Die geänderte Einstellung wird auf Programmplatz "----" gespeichert (siehe Kapitel "Automatischer Zwischenspeicher"). Das originale Programm wird nicht überschrieben.

## 24 Integral RCF (∫RCF)

Das Integral RCF (∫RCF) ist ein Maß für die Sedimentationswirkung ( $\int n^2 dt$ ). Dieser Zahlenwert dient zum Vergleich von Zentrifugationsläufen. Zur Abfrage des Integral RCF die Taste **[∫RCF]** gedrückt halten.

## 25 Anzeige der maximalen Drehzahl des Rotors

- Die Taste **[RPM]** so oft drücken, bis der Parameter RPM angezeigt und das Eingabefeld invers angezeigt wird.
- Die Taste **[RPM]** noch 1x drücken und gedrückt halten, die maximale Drehzahl des Rotors (n-max-Rotor) wird angezeigt.

## 26 Anzeige der maximalen RCF des Rotors

- Die Taste **[RCF]** so oft drücken, bis der Parameter RCF/RZB angezeigt und das Eingabefeld invers angezeigt wird.
- Die Taste **[RCF]** noch 1x drücken und gedrückt halten, die maximale RCF des Rotors (RCF-max-Rotor) wird angezeigt.

## 27 Not-Stop

- Die Taste **[STOP]** 2x drücken. Das Symbol **STOP** blinkt in der Anzeige.

Beim Not-Stop erfolgt der Auslauf mit Bremsstufe R9 (kürzeste Auslaufzeit). War die Bremsstufe R0 vorgewählt, so ist die Auslaufzeit technisch bedingt länger als mit Bremsstufe R9.

## 28 Akustisches Signal

Das akustische Signal ertönt nach folgender Einstellung:

<b>OFF</b>	<ul style="list-style-type: none"> <li>• bei Auftreten einer Störung im 2 s-Intervall.</li> </ul>
<b>ON1</b>	<ul style="list-style-type: none"> <li>• bei Auftreten einer Störung im 2 s-Intervall.</li> <li>• nach Beendigung des Zentrifugationslaufes und Stillstand des Rotors im 30 s-Intervall.</li> </ul>
<b>ON2</b>	<ul style="list-style-type: none"> <li>• bei Auftreten einer Störung im 2 s-Intervall.</li> <li>• nach Beendigung des Zentrifugationslaufes und Stillstand des Rotors im 30 s-Intervall.</li> <li>• bei jedem Tastendruck.</li> </ul>

Durch Öffnen des Deckels oder Drücken einer beliebigen Taste wird das akustische Signal beendet.

Das Signal kann, bei Stillstand des Rotors, folgendermaßen eingestellt werden:

- Den Deckel öffnen.
- Die Taste **[T]** 8 Sekunden gedrückt halten.  
Nach 8 Sekunden wird **SOUND / BELL XXX** angezeigt.
- Mit dem Drehknopf **⊖** die gewünschte Funktion (OFF, ON1, ON2) einstellen.
- Die Taste **[START]** drücken, um die Einstellung zu speichern.  
Als Bestätigung wird kurzzeitig **\*\*\* ok \*\*\*** angezeigt.

## 29 Betriebsstunden-Abfrage

Die Abfrage der Betriebsstunden ist nur bei Stillstand des Rotors möglich.

- Den Deckel öffnen.
- Die Taste **[T]** 8 Sekunden gedrückt halten.  
Nach 8 Sekunden wird **SOUND / BELL XXX** angezeigt.
- Die Taste **[T]** noch 1x drücken.  
Die Betriebsstunden (**CONTROL:** ) der Zentrifuge werden angezeigt.  
Die Betriebsstunden-Anzeige erlischt automatisch nach 10 Sekunden.

## 30 Datums- und Uhrzeit-Einstellung

Die Datums- und Uhrzeit-Einstellung ist nur bei Stillstand des Rotors möglich.

- Den Deckel öffnen.
- Die Taste **[T]** 8 Sekunden gedrückt halten.  
Nach 8 Sekunden wird **SOUND / BELL XXX** angezeigt.
- Die Taste **[T]** noch 2x drücken.  
Das Datum und die Uhrzeit werden angezeigt (a: Jahr, mon: Monat, d: Tag, h: Stunden, min: Minuten).
- Die Taste **[ ]** so oft drücken bis das Eingabefeld des gewünschten Parameters invers angezeigt wird.
- Mit dem Drehknopf **⊖** den gewünschten Wert einstellen.
- Die Taste **[START]** drücken, um die Einstellung zu speichern.  
Als Bestätigung wird kurzzeitig **\*\*\* ok \*\*\*** angezeigt.
- Zum Verlassen der Datums- und Uhrzeit-Einstellung eine beliebige Taste, außer den Tasten **[ ]**, **[T]** und **[START]**, drücken.

### 31 Angezeigte Zentrifugations-Daten nach dem Einschalten

Nach dem Einschalten werden die Zentrifugations-Daten des Programms 1, oder die des zuletzt benutzten Programms angezeigt. Dies kann wie folgt eingestellt werden:

- Den Deckel öffnen.
- Den Netzschalter ausschalten und wieder einschalten. Schalterstellung I.
- Bei der ersten optischen Änderung in der Anzeige (inverse Anzeige) die Taste **(STOP)** drücken. **PROGRAM 1, LAST PROGRAM** wird angezeigt.
- Mit dem Drehknopf **(O)** die gewünschte Funktion einstellen.
- Die Taste **(START)** drücken, um die Einstellung zu speichern. Als Bestätigung wird kurzzeitig **\*\*\* ok \*\*\*** angezeigt.

### 32 Sofortige Anzeige der Zentrifugations-Daten nach dem Einschalten

- Den Netzschalter einschalten. Schalterstellung I.
- Bei der ersten optischen Änderung in der Anzeige (inverse Anzeige) eine beliebige Taste, außer der Taste **(STOP)**, drücken. Die Zentrifugations-Daten werden sofort angezeigt.

### 33 Schlüsselschalter

Mit dem Schlüsselschalter können folgende Programm-Verriegelungen eingestellt werden:

Linke Schlüssel-Stellung: **LOCK 1** wird angezeigt.

Programme können nur abgerufen, jedoch nicht verändert werden.

Rechte Schlüssel-Stellung: **LOCK 2** wird angezeigt.

Es können keine Programme abgerufen und verändert werden.

Mittlere Schlüssel-Stellung: keine Status-Anzeige.

Keine Programmverriegelung. Programme können abgerufen und geändert werden.

### 34 Programmverknüpfung (nur bei Zentrifuge mit Programmverknüpfung)

Mit Hilfe der Programmverknüpfung können mehrere Zentrifugationsläufe miteinander verknüpft werden.

#### 34.1 Programme verknüpfen



Eine Programmverknüpfung ist nur mit Programmen möglich, bei denen Anlauf- und Bremsstufen eingestellt sind.

Die Programme müssen vor der Verknüpfung entweder durch Programm-Eingabe oder Programm-Abruf in der gewünschten Reihenfolge gespeichert werden (siehe Kapitel "Programmierung").

Die Programmplätze müssen hintereinander liegen (z.B. Programmplätze 10+11+12).

1. Die Taste **(PROG)** drücken, um den Parameter PROG-Nr anzuwählen. Das Eingabefeld wird invers angezeigt.
2. Mit dem Drehknopf **(O)** den Programmplatz des Anfangs-Programms (XX+) einstellen.
3. Die Taste **(RCL)** drücken. Die Zentrifugations-Daten des angewählten Programmplatzes werden angezeigt.
4. Die Taste **(PROG)** 2x drücken, um den Parameter PR-PART anzuwählen. Das Eingabefeld wird invers angezeigt.
5. Die Taste **(STO)** 2x drücken. Das Programm wird verknüpft und die Programmnummer des nächsten Programmplatzes (+XX+) wird angezeigt.
6. Die Taste **(RCL)** 2x drücken. Die Zentrifugations-Daten des angewählten Programmplatzes werden angezeigt.
7. Die Taste **(STO)** 2x drücken. Das Programm wird verknüpft und die Programmnummer des nächsten Programmplatzes (+XX+) wird angezeigt.
8. Die Schritte 6 und 7 so oft wiederholen, bis alle Programme verknüpft sind.
9. Zum Beenden die Taste **(PROG)** drücken. Die Programmnummer des End-Programms (+XX) wird angezeigt.

#### 34.2 Programmverknüpfung ändern

- Das gewünschte Programm abrufen (siehe Kapitel "Programm-Abruf"), die gewünschten Parameter ändern (siehe Kapitel "Zentrifugations-Parameter eingeben"), und die geänderten Zentrifugations-Daten wieder auf demselben Programmplatz speichern (siehe Kapitel "Programm-Eingabe / -Änderung"). Durch die Speicherung wird die Programmverknüpfung aufgehoben.
- Die Programme wieder verknüpfen (siehe Kapitel "Programme verknüpfen").

### 34.3 Zentrifugationslauf mit Programmverknüpfung

- Die Taste **PROG** 2x drücken, um den Parameter PR-PART anzuwählen. Das Eingabefeld wird invers angezeigt.
- Mit dem Drehknopf **○** den Programmplatz des Anfangs-Programms (XX+) einstellen.
- Die Taste **RCL** drücken. Die Zentrifugations-Daten des angewählten Programmplatzes werden angezeigt.
- Die Taste **START** drücken. Die Rotationsanzeige **●** erfolgt solange der Rotor dreht.  
Die Anlauf- und Bremsstufen der Programmverknüpfung werden angezeigt:

 Anfangs-Programm (XX+)  
**x**: Anlaufstufe des Anfangs-Programms

 Folge-Programm (+XX+)  
**x**: Anlaufstufe des Folge-Programm

 End-Programm (+XX)  
**x**: Anlaufstufe des End-Programm  
**y**: Bremsstufe des End-Programms

- Nach Ablauf der Zeit im End-Programm, erfolgt der Auslauf mit der Bremsstufe des End-Programms. Bei Abbruch des Zentrifugationslaufes durch Drücken der Taste **STOP**, erfolgt der Auslauf mit der Bremsstufe des gerade laufenden Programms.

### 34.4 Programmverknüpfung löschen

- Die Taste **PROG** drücken, um den Parameter PROG-Nr anzuzeigen. Das Eingabefeld wird invers angezeigt.
- Mit dem Drehknopf **○** den Programmplatz des Anfangs-Programms (XX+) einstellen.
- Die Taste **RCL** drücken. Die Zentrifugations-Daten des angewählten Programmplatzes werden angezeigt.
- Die Taste **PROG** 2x drücken, um den Parameter PR-PART anzuzeigen. Das Eingabefeld wird invers angezeigt.
- Die Taste **STO** 2x drücken.
- Die Taste **PROG** drücken.

### 35 Kühlung

Der Temperatur-Sollwert kann von -20°C bis +40°C eingestellt werden. Bei Zentrifugen mit Option Heizen/Kühlen ist der Temperatur-Sollwert von -20°C bis +60°C einstellbar. Die tiefste erreichbare Temperatur ist rotorabhängig (siehe Kapitel "Anhang/Appendix, Rotoren und Zubehör/Rotors and accessories"). Weicht die Ist-Temperatur von der Soll-Temperatur um mehr als 5 °C ab, wird dies durch eine blinkende Anzeige des Temperaturwertes signalisiert[blo55].

#### 35.1 Standby-Kühlung

Bei Stillstand des Rotors und geschlossenem Deckel wird der Schleuderraum auf die vorgewählte Temperatur gekühlt. Im Display wird der Temperatur-Sollwert angezeigt.

#### 35.2 Vorkühlen des Rotors

Zum schnellen Vorkühlen des unbeladenen Rotors und des Zubehörs, empfiehlt sich ein Zentrifugationslauf mit den Einstellungen Dauerlauf und einer Drehzahl von ca. 20% der maximalen Drehzahl des Rotors.

### 36 Heizung

Während des Zentrifugationslaufes wird bei Bedarf der Schleuderraum auf die vorgewählte Temperatur geheizt. Bei Stillstand des Rotors ist die Heizung ausgeschaltet[blo56].



Verbrennungsgefahr! Die Oberflächen-Temperatur des Heizelements im Schleuderraum der Zentrifuge kann bis zu 500°C / 932°F betragen. Das Heizelement nicht berühren[blo57].

### 37 Relative Zentrifugalbeschleunigung (RCF)

Die relative Zentrifugalbeschleunigung (RCF) wird als Vielfaches der Erdbeschleunigung (g) angegeben. Sie ist ein einheitsfreier Zahlenwert und dient zum Vergleich der Trenn- und Sedimentationsleistung.

Die Berechnung erfolgt nach der Formel:

$$\text{RCF} = \left( \frac{\text{RPM}}{1000} \right)^2 \times r \times 1,118 \quad \Rightarrow \quad \text{RPM} = \sqrt{\frac{\text{RCF}}{r \times 1,118}} \times 1000$$

RCF = Relative Zentrifugalbeschleunigung

RPM = Drehzahl

r = Zentrifugerradius in mm = Abstand von der Mitte der Drehachse bis zum Zentrifugiergefäßboden.  
Zentrifugerradius siehe Kapitel "Anhang/Appendix, Rotoren und Zubehör/Rotors and accessories".



Die relative Zentrifugalbeschleunigung (RCF) ist von der Drehzahl und dem Zentrifugerradius abhängig.

### 38 Zentrifugation von Stoffen oder Stoffgemischen mit einer höheren Dichte als 1,2 kg/dm<sup>3</sup>

Bei der Zentrifugation mit maximaler Drehzahl darf die Dichte der Stoffe oder Stoffgemische 1,2 kg/dm<sup>3</sup> nicht überschreiten.

Bei Stoffen oder Stoffgemischen mit einer höheren Dichte muss die Drehzahl reduziert werden.

Die erlaubte Drehzahl lässt sich nach folgender Formel berechnen:

$$\text{Reduzierte Drehzahl } (n_{\text{red}}) = \sqrt{\frac{1,2}{\text{höhere Dichte [kg/dm}^3]}} \times \text{maximale Drehzahl [RPM]}$$

z.B.: Maximale Drehzahl 4000 RPM, Dichte 1,6 kg/dm<sup>3</sup>

$$n_{\text{red}} = \sqrt{\frac{1,2 \text{ kg/dm}^3}{1,6 \text{ kg/dm}^3}} \times 4000 \text{ RPM} = 3464 \text{ RPM}$$

Wird im Ausnahmefall die, auf dem Gehänge angegebene, maximale Beladung überschritten, muss die Drehzahl ebenfalls reduziert werden.

Die erlaubte Drehzahl lässt sich nach folgender Formel berechnen:

$$\text{Reduzierte Drehzahl } (n_{\text{red}}) = \sqrt{\frac{\text{maximale Beladung [g]}}{\text{tatsächliche Beladung [g]}}} \times \text{maximale Drehzahl [RPM]}$$

z.B.: Maximale Drehzahl 4000 RPM, maximale Beladung 300 g, tatsächliche Beladung 350 g

$$n_{\text{red}} = \sqrt{\frac{300 \text{ g}}{350 \text{ g}}} \times 4000 \text{ RPM} = 3703 \text{ RPM}$$

Bei eventuellen Unklarheiten ist Auskunft beim Hersteller einzuholen.

### 39 Rotorerkennung

Nach Start eines jeden Zentrifugationslaufes wird eine Rotorerkennung durchgeführt.

Wurde der Rotor gewechselt, wird der Zentrifugationslauf nach der Rotorerkennung abgebrochen. Der Rotorcode (rot xx) des Rotors wird angezeigt. Der Rotorcode (R xx) sowie die maximale Drehzahl (n-max=xxxxx) des Rotors werden angezeigt.



Eine weitere Bedienung der Zentrifuge ist erst nach einmaligem Öffnen des Deckels möglich.

Wenn die maximale Drehzahl des verwendeten Rotors kleiner als die eingestellte Drehzahl ist, wird die Drehzahl auf die maximale Drehzahl des Rotors begrenzt.

### 40 Notentriegelung

Bei einem Stromausfall kann der Deckel nicht motorisch entriegelt werden. Es muss eine Notentriegelung von Hand durchgeführt werden.



Zur Notentriegelung die Zentrifuge vom Netz trennen. Bei fest angeschlossenen Geräten, den Netzschalter zur Trennung der Netzversorgung des Geräts in der Gebäudeinstallation ausschalten und gegen ein Wiedereinschalten sichern, z. B. durch Abschließen des Schalters.

Den Deckel nur bei Stillstand des Rotors öffnen.

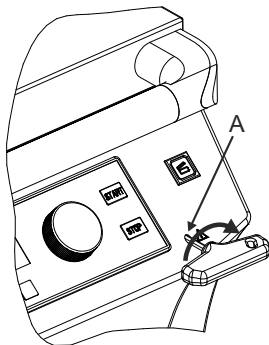

- Den Netzschalter ausschalten (Schalterstellung "0").
- Durch das Fenster im Deckel schauen, um sich zu vergewissern, dass der Rotor stillsteht.
- Den Sechskant-Stiftschlüssel waagrecht in die Bohrung (A) einführen und vorsichtig eine halbe Umdrehung im Uhrzeigersinn drehen, bis sich der Deckel öffnen lässt.
- Den Sechskant-Stiftschlüssel wieder aus der Bohrung herausziehen.
- Nach dem Wiedereinschalten der Zentrifuge die Taste  drücken, dass die motorische Deckelverriegelung wieder die Grundstellung (geöffnet) einnimmt.

## 41 Pflege und Wartung



Das Gerät kann kontaminiert sein.



Vor der Reinigung den Netzstecker ziehen. Bei fest angeschlossenen Geräten, den Netzschalter zur Trennung der Netzversorgung des Geräts in der Gebäudeinstallation ausschalten und gegen ein Wiedereinschalten sichern, z. B. durch Abschließen des Schalters.

Bevor ein anderes als das vom Hersteller empfohlene Reinigungs- oder Dekontaminationsverfahren angewandt wird, hat sich der Benutzer beim Hersteller zu vergewissern, dass das vorgesehene Verfahren das Gerät nicht schädigt.

- Zentrifugen, Rotoren und das Zubehör dürfen nicht in Spülmaschinen gereinigt werden.
- Es darf nur eine Handreinigung und eine Flüssig-Desinfektion durchgeführt werden.
- Die Wassertemperatur muss 20 – 25°C betragen.
- Es dürfen nur Reinigungs- oder Desinfektionsmittel verwendet werden, die:
  - im pH-Bereich 5 - 8 liegen,
  - keine Ätzalkalien, Peroxide, Chlorverbindungen, Säuren und Laugen enthalten.
- Um Korrosionserscheinungen durch Reinigungs- oder Desinfektionsmittel zu vermeiden sind die speziellen Anwendungshinweise vom Hersteller des Reinigungs- oder Desinfektionsmittels unbedingt zu beachten.

### 41.1 Zentrifuge (Gehäuse, Deckel und Schleuderraum)

#### 41.1.1 Oberflächenreinigung und -pflege

- Das Gehäuse der Zentrifuge und den Schleuderraum regelmäßig säubern und bei Bedarf mit Seife oder einem milden Reinigungsmittel und einem feuchten Tuch reinigen. Dies dient zum einen der Hygiene und es verhindert Korrosion durch anhaftende Verunreinigungen.
- Inhaltsstoffe geeigneter Reinigungsmittel:  
Seife, anionische Tenside, nichtionische Tenside.
- Nach dem Einsatz von Reinigungsmitteln, die Reste des Reinigungsmittels, durch Nachwischen mit einem feuchten Tuch, entfernen.
- Die Flächen müssen unmittelbar nach der Reinigung getrocknet werden.
- Bei Bildung von Kondenswasser den Schleuderraum, durch Auswischen mit einem saugfähigen Tuch, trocknen.
- Die Gummidichtung des Schleuderraums nach jeder Reinigung mit einem Gummi-Pflegemittel leicht einreiben.
- Der Schleuderraum ist jährlich auf Schäden zu überprüfen.



Werden sicherheitsrelevante Schäden festgestellt, darf die Zentrifuge nicht mehr in Betrieb genommen werden. In diesem Fall ist der Kundendienst zu benachrichtigen.

#### 41.1.2 Oberflächendesinfektion

- Gelangt infektiöses Material in den Schleuderraum, so ist dieser umgehend zu desinfizieren.
- Inhaltsstoffe geeigneter Desinfektionsmittel:  
Äthanol, n-Propanol, Ethylhexanol, anionische Tenside, Korrosionsinhibitoren.
- Nach dem Einsatz von Desinfektionsmitteln, die Reste des Desinfektionsmittels, durch Nachwischen mit einem feuchten Tuch, entfernen.
- Die Flächen müssen unmittelbar nach der Desinfektion getrocknet werden.

#### 41.1.3 Entfernen radioaktiver Verunreinigungen

- Das Mittel muss speziell für das Entfernen radioaktiver Verunreinigungen ausgewiesen sein.
- Inhaltsstoffe geeigneter Mittel für das Entfernen radioaktiver Verunreinigungen:  
Anionische Tenside, nichtionische Tenside, polyhydrierter Äthanol.
- Nach dem Entfernen der radioaktiven Verunreinigungen, die Reste des Mittels, durch Nachwischen mit einem feuchten Tuch, entfernen.
- Die Flächen müssen unmittelbar nach dem Entfernen der radioaktiven Verunreinigungen getrocknet werden.

## 41.2 Rotoren und Zubehör

### 41.2.1 Reinigung und Pflege

- Um einer Korrosion und Materialveränderungen vorzubeugen müssen die Rotoren und das Zubehör regelmäßig mit Seife oder einem milden Reinigungsmittel und einem feuchten Tuch gereinigt werden. Die Reinigung wird mindestens einmal wöchentlich empfohlen. Verschmutzungen müssen sofort entfernt werden.
- Inhaltsstoffe geeigneter Reinigungsmittel:  
Seife, anionische Tenside, nichtionische Tenside.
- Nach dem Einsatz von Reinigungsmitteln, die Reste des Reinigungsmittels, durch Nachspülen mit Wasser (nur außerhalb der Zentrifuge) oder Nachwischen mit einem feuchten Tuch, entfernen.
- Die Rotoren und das Zubehör müssen unmittelbar nach der Reinigung getrocknet werden.
- Winkelrotoren, Behälter und Gehänge aus Aluminium sind nach dem Trocknen mit säurefreiem Fett z.B. Vaseline leicht einzufetten.
- Bei Bio-Sicherheitssystemen sind die Dichtungsringe wöchentlich zu reinigen.  
Die Dichtungsringe sind aus Silikon hergestellt. Um die Dichtigkeit der Bio-Sicherheitssysteme zu gewährleisten, dürfen die Dichtungsringe nach der Reinigung oder nach dem Autoklavieren nicht mit Talkum-Puder behandelt werden.  
Vor jedem Gebrauch des Bio-Sicherheitssystems müssen alle Teile des Bio-Sicherheitssystems visuell auf Beschädigung überprüft werden. Außerdem muss die korrekte Einbaulage des Dichtungsringes bzw. der Dichtungsringe des Bio-Sicherheitssystems überprüft werden.  
Die beschädigten Teile des Bio-Sicherheitssystems müssen sofort ausgetauscht werden.  
Bei Anzeichen von Rissbildung, Versprödung oder Abnutzung ist der betreffende Dichtungsring sofort auszutauschen. Bei Deckeln mit nicht auswechselbaren Dichtungsringen muss der gesamte Deckel ausgetauscht werden.  
Lieferbare Bio-Sicherheitssysteme siehe Kapitel "Anhang/Appendix, Rotoren und Zubehör/Rotors and accessories".
- Um Korrosion infolge Feuchtigkeit zwischen Rotor und Motorwelle zu verhindern, sollte der Rotor mindestens einmal im Monat ausgebaut, gereinigt und die Motorwelle leicht gefettet werden.
- Die Rotoren und das Zubehör sind wöchentlich auf Verschleiß und Korrosionsschäden zu überprüfen.  
Bei Ausschwingrotoren muss vor allem der Bereich der Tragzapfen und bei Gehängen die Nuten und der Boden auf Risse geprüft werden.  
Beispiel: Riss im Bereich der Nut:

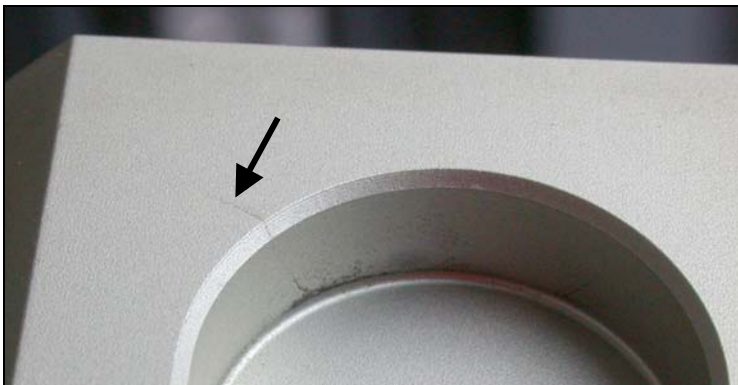

Rotoren und Zubehör dürfen bei Anzeichen von Verschleiß oder Korrosion nicht mehr verwendet werden.

- Den Rotor wöchentlich auf festen Sitz prüfen.

### 41.2.2 Desinfektion

- Gelangt infektiöses Material auf die Rotoren oder auf das Zubehör, so muss eine geeignete Desinfektion durchgeführt werden.
- Inhaltsstoffe geeigneter Desinfektionsmittel:  
Äthanol, n-Propanol, Ethylhexanol, anionische Tenside, Korrosionsinhibitoren.
- Nach dem Einsatz von Desinfektionsmitteln, die Reste des Desinfektionsmittels, durch Nachspülen mit Wasser (nur außerhalb der Zentrifuge) oder Nachwischen mit einem feuchten Tuch, entfernen.
- Die Rotoren und das Zubehör müssen unmittelbar nach der Desinfektion getrocknet werden.



#### 41.2.3 Entfernen radioaktiver Verunreinigungen

- Das Mittel muss speziell für das Entfernen radioaktiver Verunreinigungen ausgewiesen sein.
- Inhaltsstoffe geeigneter Mittel für das Entfernen radioaktiver Verunreinigungen: Anionische Tenside, nichtionische Tenside, polyhydrierter Äthanol.
- Nach dem Entfernen der radioaktiven Verunreinigungen, die Reste des Mittels, durch Nachspülen mit Wasser (nur außerhalb der Zentrifuge) oder Nachwischen mit einem feuchten Tuch, entfernen.
- Die Rotoren und das Zubehör müssen unmittelbar nach dem Entfernen der radioaktiven Verunreinigungen getrocknet werden.

#### 41.2.4 Tragzapfen

Bei Ausschwingrotoren müssen die Tragzapfen regelmäßig gefettet werden (Hettich-Schmierfett Nr. 4051), um ein gleichmäßiges Ausschwingen der Gehänge zu gewährleisten.

#### 41.2.5 Rotoren und Zubehör mit begrenzter Verwendungsdauer

Die Verwendung von bestimmten Rotoren, Gehängen und Zubehörteilen ist zeitlich begrenzt.

Diese sind mit der maximal erlaubten Anzahl der Laufzyklen oder dem Ablaufdatum und der maximalen Anzahl der Laufzyklen oder nur mit dem Ablaufdatum gekennzeichnet, z.B.:

- "einsetzbar bis Ende: IV. Quartal 2011 / usable until end of: IV. Quartal 2011" oder "einsetzbar bis Ende Monat/Jahr: 10/2011 / usable until end of month/year: 10/2011"
- "max. Laufzyklen / max. cycles: 40000".



Aus Sicherheitsgründen dürfen die Rotoren, Gehänge und Zubehörteile nicht mehr verwendet werden, wenn entweder die darauf gekennzeichnete maximal erlaubte Anzahl der Laufzyklen oder das darauf gekennzeichnete Ablaufdatum erreicht ist.

#### 41.2.6 Berechnung der Anzahl der durchgeführten Laufzyklen

Zur Berechnung der Anzahl der durchgeführten Laufzyklen (Zentrifugationsläufe) werden die Laufzeit pro Zentrifugationslauf und die Betriebsstunden des Gerätes benötigt.

Abfrage der Betriebsstunden siehe Kapitel "Betriebsstunden-Abfrage".

Wurden Zentrifugationsläufe mit unterschiedlichen Laufzeiten durchgeführt, so ist zur Berechnung die kürzeste Laufzeit zu verwenden.

Die Anzahl der durchgeführten Laufzyklen (Zentrifugationsläufe) werden wie folgt berechnet:

Anzahl durchgeführter Laufzyklen = Betriebsstunden [h] x 60 ÷ Laufzeit [min]

z. B.: Betriebsstunden 2000 h, Laufzeit 5 min

Anzahl durchgeführter Laufzyklen = 2000 x 60 ÷ 5 = 24000

### 41.3 Autoklavieren

Das folgende Zubehör darf bei 121°C / 250°F (20 min) autoklaviert werden:

- Ausschwingrotoren
- Winkelrotoren aus Aluminium
- Gehänge aus Metall
- Deckel mit Bioabdichtung
- Adapter

Über den Sterilitätsgrad kann keine Aussage gemacht werden.



Die Deckel der Rotoren und Behälter müssen vor dem Autoklavieren abgenommen werden.

Das Autoklavieren beschleunigt den Alterungsprozess von Kunststoffen. Außerdem kann es bei Kunststoffen Farbveränderungen verursachen.

Nach dem Autoklavieren sind die Rotoren und das Zubehör visuell auf Beschädigung zu überprüfen und eventuell beschädigte Teile sofort auszutauschen.

Bei Anzeichen von Rissbildung, Versprödung oder Abnutzung ist der betreffende Dichtungsring sofort auszutauschen.

Bei Deckeln mit nicht auswechselbaren Dichtungsringen muss der gesamte Deckel ausgetauscht werden.

Um die Dichtigkeit der Bio-Sicherheitssysteme zu gewährleisten, dürfen die Dichtungsringe nach dem Autoklavieren nicht mit Talkum-Puder behandelt werden.

### 41.4 Zentrifugiergefäße

- Bei Undichtigkeit oder nach dem Bruch von Zentrifugiergefäßen, sind zerbrochene Gefäßteile, Glassplitter und ausgelaufenes Zentrifugiergut vollständig zu entfernen.
- Die Gummieinlagen sowie die Kunststoff-Hülsen der Rotoren sind nach einem Glasbruch zu ersetzen.



Verbleibende Glassplitter verursachen weiteren Glasbruch!

- Handelt es sich um infektiöses Material so ist umgehend eine Desinfektion durchzuführen.

## 42 Störungen

Lässt sich der Fehler laut Störungstabelle nicht beheben, so ist der Kundendienst zu benachrichtigen.

Bitte den Zentrifugentyp und die Seriennummer angeben. Beide Nummern sind auf dem Typenschild der Zentrifuge ersichtlich.



Einen NETZ-RESET durchführen:

- Den Netzschalter ausschalten (Schalterstellung "0").
- Mindestens 10 Sekunden lang warten und anschließend den Netzschalter wieder einschalten (Schalterstellung "1").

Anzeige		Ursache	Beseitigung
keine Anzeige	---	keine Spannung. Auslösen der Überstromsicherungsicherung.	<ul style="list-style-type: none"> <li>- Versorgungsspannung überprüfen.</li> <li>- Netzschalter EIN.</li> </ul>
TACHO - ERROR	01	Tacho defekt.	<ul style="list-style-type: none"> <li>- Deckel öffnen.</li> <li>- Den Netzschalter ausschalten (Schalterstellung "0").</li> <li>- Mindestens 10 Sekunden lang warten.</li> <li>- Den Rotor von Hand kräftig drehen.</li> <li>- Den Netzschalter wieder einschalten (Schalterstellung "1"). Während des Einschaltens muss sich der Rotor drehen.</li> </ul>
	02	Kein Rotor eingebaut. Motor, Umrichter, Antrieb defekt.	
IMBALANCE / UNWUCHT	---	Der Rotor ist ungleichmäßig beladen.	<ul style="list-style-type: none"> <li>- Deckel öffnen.</li> <li>- Die Beladung des Rotors überprüfen, siehe Kapitel "Beladen des Rotors".</li> <li>- Den Zentrifugationslauf wiederholen.</li> </ul>
CONTROL - ERROR	04, 06 - 09	Fehler Deckelverriegelung	<ul style="list-style-type: none"> <li>- Einen NETZ-RESET durchführen.</li> </ul>
N > MAX	05	Überdrehzahl	
N < MIN	13	Unterdrehzahl	
ROTORCODE	10	Fehler Rotorcodierung	
MAINS INTERRUPT	---	Netzunterbrechung während des Zentrifugationslaufes. (Der Zentrifugationslauf wurde nicht beendet.)	<ul style="list-style-type: none"> <li>- Deckel öffnen.</li> <li>- Taste <b>(START)</b> drücken.</li> <li>- Bei Bedarf den Zentrifugationslauf wiederholen.</li> </ul>
VERSIONS-ERROR	12	Keine Übereinstimmung der Elektronik-Komponenten	<ul style="list-style-type: none"> <li>- Einen NETZ-RESET durchführen.</li> </ul>
SER I/O - ERROR	30 - 38	Fehler / Defekt Schnittstelle	
° C * - ERROR	50 - 56, 58	Fehler / Defekt Kühlung	
LOCK - ERROR	57	Fehler / Defekt Programm-Verriegelung	
FU / CCI - ERROR	60 - 83	Fehler / Defekt Motorsteuerung	
CONTROL-ERROR	26, 90 - 95, 97 - 99	Fehler / Defekt Steuerteil	
N > ROTOR-MAX	96	Drehzahl im angewählten Programm größer als die maximale Drehzahl des Rotors (n-max-Rotor).	<ul style="list-style-type: none"> <li>- Drehzahl überprüfen und korrigieren.</li> </ul>
		Der Rotor wurde gewechselt. Der eingebaute Rotor hat eine höhere maximale Drehzahl als der vorher verwendete Rotor, und er wurde noch nicht von der Rotorerkennung erkannt.	<ul style="list-style-type: none"> <li>- Eine Drehzahl, bis zur maximalen Drehzahl des vorher verwendeten Rotors, einstellen. Die Taste <b>(START)</b> drücken, um eine Rotorerkennung durchzuführen, siehe Kapitel "Rotorerkennung".</li> </ul>

### 43 Rücksendung von Geräten

Wird das Gerät oder dessen Zubehör an die Firma Andreas Hettich GmbH & Co. KG zurückgesandt, so muss dieses, zum Schutz von Personen, Umwelt und Material, vor dem Versand dekontaminiert und gereinigt werden.

Eine Annahme von kontaminierten Geräten oder Zubehör behalten wir uns vor.

Anfallende Kosten für Reinigungs- und Desinfektionsmaßnahmen werden dem Kunden in Rechnung gestellt.

Wir bitten dafür um Ihr Verständnis.

### 44 Entsorgung



#### Das Gerät kann über den Hersteller entsorgt werden.

Für eine Rücksendung muss immer ein Rücksendeformular (RMA) angefordert werden.

Bei Bedarf den technischen Service des Herstellers kontaktieren:

Andreas Hettich GmbH & Co. KG

Föhrenstraße 12

78532 Tuttlingen, Germany

Telefon: +49 7461 705 1400

E-Mail: [service@hettichlab.com](mailto:service@hettichlab.com)

Für die Entsorgung können Kosten anfallen.



#### WARNUNG

#### Verschmutzungs- und Kontaminationsgefahr für Mensch und Umwelt

Bei der Entsorgung der Zentrifuge können Mensch und Umwelt durch falsche oder unsachgemäße Entsorgung verschmutzt oder kontaminiert werden.

- Demontage und Entsorgung darf nur durch eine geschulte und autorisierte Servicefachkraft durchgeführt werden.

Das Gerät ist für den gewerblichen Bereich ("Business to Business" - B2B) vorgesehen.

Gemäß der Richtlinie 2012/19/EU dürfen die Geräte nicht mehr mit dem Hausmüll entsorgt werden.

Die Geräte sind nach der Stiftung Elektro-Altgeräte Register (EAR) zu den folgenden Gruppen zugeordnet.

- Gruppe 1 (Wärmeüberträger)



Mit dem Symbol der durchgestrichenen Abfalltonne wird darauf hingewiesen, dass das Gerät nicht mit dem Hausmüll entsorgt werden darf.

Die Entsorgungsvorschriften der einzelnen Länder können unterschiedlich sein. Im Bedarfsfall an den Lieferanten wenden.

## Contents

1	How to use these operating instructions .....	48
2	Symbol meanings .....	48
3	Intended use .....	49
4	Remaining risks .....	49
5	Technical specifications .....	50
6	Notes on safety .....	52
7	Unpacking and setting up the centrifuge .....	54
8	Delivery checklist .....	54
9	Transport and storage .....	55
9.1	Transport .....	55
9.2	Storage .....	55
10	Initial operation .....	55
11	Interface (only for centrifuge with interface) .....	56
12	Opening and closing the lid .....	56
12.1	Opening the lid .....	56
12.2	Closing the lid .....	56
13	Installation and removal of the rotor .....	56
14	Inserting and removing hangers into/from the rotor .....	57
15	Inserting and removing the adapters into/from the hangers .....	57
16	Loading the rotor .....	58
17	Closing biosafety systems .....	59
18	HettLiner packing instructions .....	60
18.1	Packing before centrifugation .....	60
18.2	Unpacking after centrifugation .....	61
19	Control and display devices .....	62
19.1	Status symbols .....	62
19.2	Control knob .....	62
19.3	Keys and set-up options .....	62
20	Entering centrifugation parameters .....	63
20.1	Running time .....	63
20.1.1	Time selection .....	63
20.1.2	Continuous running .....	63
20.2	Speed (RPM) .....	63
20.3	Relative centrifugal force (RCF/RZB) .....	63
20.4	Run-up and run-down parameters .....	63
20.4.1	Run-up step .....	63
20.4.2	Run-up time .....	63
20.4.3	Braking step .....	64
20.4.4	Run-down time .....	64
20.4.5	Brake de-energisation speed .....	64
20.5	Radius/Temperature .....	64
20.5.1	Radius .....	64
20.5.2	Temperature .....	64

20.6	Automatic buffer	64
21	Programming	64
21.1	Entering / modifying programs	64
21.2	Calling up programs	64
22	Centrifugation	65
22.1	Centrifugation with time selection	65
22.2	Continuous running	65
23	Changing settings during the centrifugation run	65
24	Integral RCF (jRCF)	65
25	Displaying the maximum speed of the rotor	65
26	Displaying the maximum RCF of the rotor	66
27	Emergency stop	66
28	Audible signal	66
29	Interrogating the operating hours	66
30	Setting the date and time	66
31	Centrifugation data displayed after switching on	66
32	Immediate display of the centrifugation data after switching on	67
33	Key-operated switch	67
34	Program linking (for centrifuges with program linking only)	67
34.1	Linking programs	67
34.2	Changing program links	67
34.3	Centrifugation run with program linking	68
34.4	Deleting program linking	68
35	Cooling	68
35.1	Standby-cooling	68
35.2	Pre-cooling the rotor	68
36	Heating	68
37	Relative centrifugal force (RCF)	69
38	Centrifugation of materials or mixtures of materials with a density higher than 1.2 kg/dm <sup>3</sup>	69
39	Rotor recognition	69
40	Emergency release	70
41	Maintenance and servicing	70
41.1	Centrifuge (housing, lid and centrifuging chamber)	70
41.1.1	Surface cleaning and care	70
41.1.2	Surface disinfection	71
41.1.3	Removal of radioactive contaminants	71
41.2	Rotors and Attachments	71
41.2.1	Cleaning and care	71
41.2.2	Disinfection	72
41.2.3	Removal of radioactive contaminants	72
41.2.4	Trunnions	72
41.2.5	Rotors and accessories with limited service lives	72
41.2.6	Calculation of the number of run cycles carried out	72
41.3	Autoclaving	73
41.4	Centrifuge containers	73

42	Faults .....	74
43	Returning Devices .....	75
44	Disposal .....	75
45	Anhang / Appendix .....	140
45.1	Rotoren und Zubehör / Rotors and accessories .....	140

## 1 How to use these operating instructions

- Before using the centrifuge, read the operating instructions and observe them.
- The operating instructions are a part of the device. They must always be kept readily available.
- If the device is set up at a different location, the operating instructions must be provided with it.

## 2 Symbol meanings



Symbol on the device:  
Attention, general hazard area.



Symbol on the device:  
Observe operating instructions.  
This symbol indicates that the user must observe the operating instructions provided.



Symbol in this document:  
Attention, general hazard area.  
This symbol refers to safety relevant warnings and indicates possibly dangerous situations.  
The non-adherence to these warnings can lead to material damage and injury to personal.



Symbol on the device and in this document:  
Beware of biohazard.



Symbol on the device and in this document:  
Beware of hot surface.  
Nonobservance of this warning can lead to material damage and personal injury.



Symbol on the device:  
Equipotential: Connector (PE connector) for potential equalization (only for centrifuge with PE connector).



Symbol on the device:  
Switch positions of the key-operated switch.



Symbol on the device:  
Optical interface (only for device with optical interface).



Symbol in this document:  
This symbol refers to important circumstances.



Symbol on the device and in this document:  
Symbol for the separate collection of electric and electronic devices according to the guideline 2012/19/EU.



Applies in the countries of the European Union, as well as in Norway and Switzerland.



Symbol on the shipping carton label:  
This way up.



Symbol on the shipping carton label:  
The shipping packaging must be transported and handled within the indicated humidity range (10% - 80%).

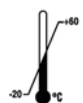

Symbol on the shipping carton label:  
The shipping packaging must be stored, transported and handled within the temperature range shown (-20°C - +60°C).



Symbol on the shipping carton label:  
The shipping packaging must be kept away from rain and kept in a dry environment.





Symbol on the shipping carton label:  
Fragile, handle with care.



Symbol on the shipping carton label:  
Stack limit. Maximum number of identical packages which may be stacked on the bottom package, whereby "n" stands for the number of permissible packages. The bottom package is not included in "n".

### 3 Intended use

This device is a laboratory centrifuge suitable for medical applications.

Their exclusive therapeutic purpose is to centrifuge blood in blood bag systems. The separated blood components are transferred by another device (separator) into corresponding satellite bags. The individual components obtained in this way are then used for transfusion or autotransfusion.

The centrifuge is only to be operated by qualified personnel working for blood donation services or hospitals.

The centrifuge is only intended for the uses referred to above.

Any other use or use beyond this is considered improper. Andreas Hettich GmbH & Co. KG shall not be liable for any damage arising from this.

Intended use also includes the observation of all instructions in the Operating Manual and compliance with the required inspection and maintenance intervals.

### 4 Remaining risks

The device is built according to the state-of-the-art and the recognized safety regulations.

If used and handled improperly, there could be life-threatening danger to the user or third parties, or the device could be impaired or there could be other property damage.

The device is only to be used for its intended purpose and only when it is in safe working condition.

Malfunctions which could affect safety must be corrected immediately.

## 5 Technical specifications

Manufacturer	Andreas Hettich GmbH & Co. KG D-78532 Tuttlingen			
Model	ROTIXA 500 RS			
Basic UDI-DI	4050674010002Q2			
Type	4950, 4950-50		4950-70, 4950-80	
Mains voltage ( $\pm 10\%$ )	230-240 V ~	220 V ~	230-240 V ~	220 V ~
Mains frequency	50 Hz	60 Hz	50 Hz	60 Hz
Connected load	3800 VA			
Current consumption	16 A			
Cooling medium	R452A			
Max. capacity	4 x 1000 ml			
Allowed density	1.2 kg/dm <sup>3</sup>			
Speed (RPM)	11500			
Force (RCF)	18038			
Kinetic energy	59620 Nm			
Obligatory inspection (DGUV Regel 100 – 500)	yes			
Ambient conditions (EN / IEC 61010-1)	<p>Indoors only Up to 2000 m above sea level 5°C to 35°C Maximum relative humidity 80% for temperatures up to 31°C, linearly decreasing to 50% relative humidity at 40°C.</p>			
– Set-up site				
– Altitude				
– Ambient temperature				
– Humidity				
– Excess-voltage category (IEC 60364-4-443)	II			
– Pollution degree	2			
Device protection class	I			
Not suitable for use in explosion-endangered areas.				
EMC	EN / IEC 61326-1, Class B			
– Emitted interference, Interference immunity				
Noise level (dependent on rotor)	$\leq 65$ dB(A)		$\leq 63$ dB(A)	
Dimensions				
– Width	650 mm			
– Depth	814 mm			
– Height	973 mm			
Weight	approx. 219 kg		approx. 233 kg	

Manufacturer	Andreas Hettich GmbH & Co. KG D-78532 Tuttlingen	
Model	ROTIXA 500 RS	
Basic UDI-DI	4050674010002Q2	
Type	4950-08, 4950-58	4950-78, 4950-88
Mains voltage ( $\pm 10\%$ )	208 V ~	
Mains frequency	60 Hz	
Connected load	3800 VA	
Current consumption	18 A	
Cooling medium	R452A	
Max. capacity	4 x 1000 ml	
Allowed density	1.2 kg/dm <sup>3</sup>	
Speed (RPM)	11500	
Force (RCF)	18038	
Kinetic energy	59620 Nm	
Obligatory inspection (DGUV Regel 100 – 500)	yes	
Ambient conditions (EN / IEC 61010-1)	<p>Indoors only Up to 2000 m above sea level 5°C to 35°C Maximum relative humidity 80% for temperatures up to 31°C, linearly decreasing to 50% relative humidity at 40°C.</p>	
– Set-up site		
– Altitude		
– Ambient temperature		
– Humidity		
– Excess-voltage category (IEC 60364-4-443)	II	
– Pollution degree	2	
Device protection class	I	
Not suitable for use in explosion-endangered areas.		
EMC	FCC Class B	
– Emitted interference, Interference immunity		
Noise level (dependent on rotor)	$\leq 65$ dB(A)	$\leq 63$ dB(A)
Dimensions		
– Width	650 mm	
– Depth	814 mm	
– Height	973 mm	
Weight	approx. 225 kg	approx. 239 kg

## 6 Notes on safety



**No claim of warranty will be considered by the manufacturer unless ALL instructions in this manual have been followed.**



### Reports of serious incidents involving the device

Report any serious incidents involving the device to the manufacturer and, if necessary, to the competent authority.



- The centrifuge should be installed on a good, stable base.
- Before using the centrifuge absolutely check the rotor for firm placement.
- When the centrifuge is running, according to EN / IEC 61010-2-020, no persons, dangerous substances or objects may be within the safety margin of 300 mm around the centrifuge.
- Rotors, suspensions and accessories that possess traces of corrosion or mechanical damage or if their term of use has expired may not be used any longer.
- The centrifuge may no longer be put into operation when the centrifuging chamber has safety-related damages.
- With swing-out rotors the trunnions must be regularly lubricated (Hettich Lubricating Grease No. 4051) in order to ensure consistent swinging out of the hangers.
- For centrifuges without temperature control, when the room temperature is increased and/or if the device is frequently used, the centrifuging chamber could be heated up. Therefore, it can't be ruled out that the sample material might be changed due to the temperature.

- Before the initial operation of your centrifuge you should read and pay attention to the operating instructions. Only personnel that has read and understood the operating instructions are allowed to operate the device.
- Along with the operating instructions and the legal regulations on accident prevention, you should also follow the recognised professional regulations for working in a safe and professional manner. These operating instructions should be read in conjunction with any other instructions concerning accident prevention and environmental protection based on the national regulations of the country where the device is to be used.
- This centrifuge is a state-of-the-art piece of equipment which is extremely safe to operate. However, it can lead to danger for users or others if used by untrained staff, in an inappropriate way or for a purpose other than that it was designed for.
- The centrifuge must not be moved or knocked during operation.
- In case of fault or emergency release, never touch the rotor before it has stopped turning.
- To avoid damage due to condensate, when changing from a cold to a warm room the centrifuge must either heat up for at least 3 hours in the warm room before being connected to the mains, or run hot for 30 minutes in the cold room.
- Only the rotors and accessories approved by the manufacturer for this device may be used (see chapter "Anhang/Appendix, Rotoren und Zubehör/Rotors and accessories"). Before centrifuge vessels are used which are not listed in the chapter "Appendix, Rotors and accessories", the user must make sure they can be used by asking the manufacturer.
- The centrifuge rotor may only be loaded in accordance with the chapter "Loading the rotor".
- When centrifuging with maxim revolutions per minute the density of the materials or the material mixtures may not exceed 1.2 kg/dm<sup>3</sup>.
- The centrifuge may only be operated when the balance is within the bounds of acceptability.
- The centrifuge may not be operated in explosion-endangered areas.
- The centrifuge must not be used with:
  - inflammable or explosive materials
  - materials that react with one another producing a lot of energy.
 When centrifuging petrochemical samples according to the specifications of the ASTM, the user must carry out a risk assessment.

- When centrifuging hazardous substances or mixtures, which are toxic, radioactive or contaminated with pathogenic microorganisms, suitable measures must be taken by the user.  
Fundamentally, centrifuge containers with special screw closures must be used for hazardous substances. For materials of risk groups 3 and 4, in addition to sealable centrifuge containers, a bio-safety system must be used (see the "Laboratory Bio-safety Manual" from the World Health Organization).  
In a bio-safety system, a bio-seal (sealing ring) prevents droplets and aerosols from escaping.  
If the hanger of a bio-safety system is used without the lid, the sealing ring must be removed from the hanger to prevent damage to the sealing ring during the centrifugation run.  
Damaged bio-safety systems are no longer microbiologically sealed.  
If a bio-safety system is not used, a centrifuge is not microbiologically sealed for the purposes of the standard EN / IEC 61010-2-020.  
When closing a bio-safety system, follow the instructions in the chapter "Closing biosafety systems".  
For the available bio-safety systems, see the chapter "Appendix, Rotors and accessories". If in doubt, you can get the information you need from the manufacturer.
- The centrifuge must not be operated with highly corrosive substances which could impair the mechanical integrity of rotors, hangers and accessories.
- Repairs must only be carried out by personnel authorised to do so by the manufacturer.
- Only original spare parts and original accessories licensed by the Andreas Hettich GmbH & Co. KG company are allowed to be utilised.
- The following safety regulations apply:  
EN / IEC 61010-1 and EN / IEC 61010-2-020 as well as their national deviations.
- The safe operation and reliability of the centrifuge can only be guaranteed if:
  - the centrifuge is operated in accordance with the operating instructions,
  - the electrical installation on the site where the centrifuge is installed conforms to the demands of EN / IEC stipulations,
- Meeting the country-specific requirements concerning occupational safety with regard to the use of laboratory centrifuges at the workplaces provided for this purpose by the user is the responsibility of the user.

## 7 Unpacking and setting up the centrifuge

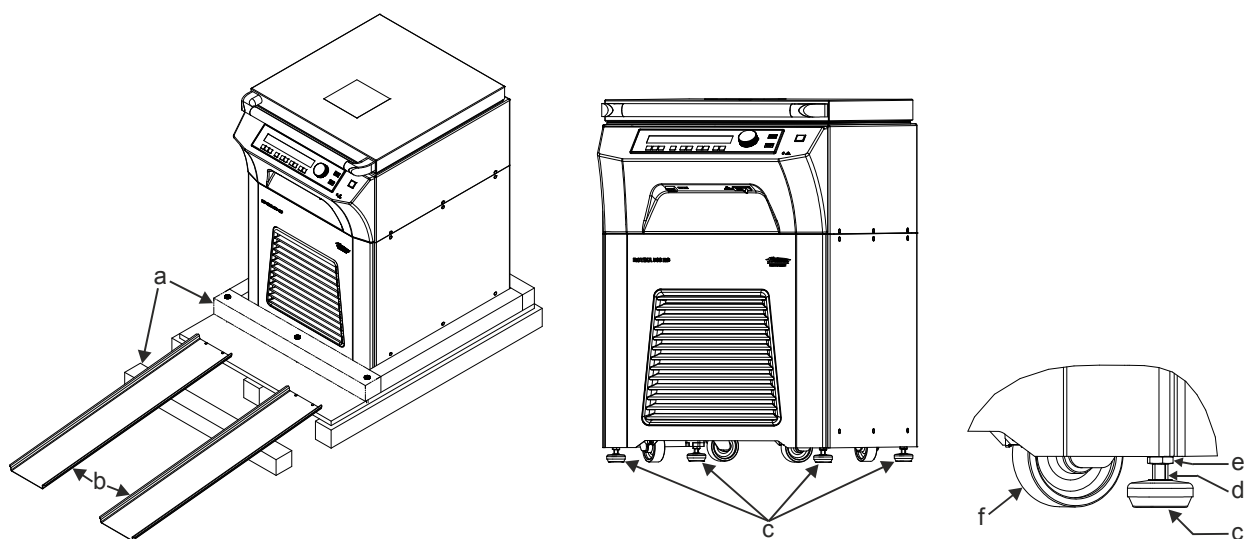

- Remove the packaging.
- Remove the front wooden beam (a).
- Fasten the metal rails (b) to the wooden pallet with two nails each.
- Push the front wooden beam (a) under the metal rails (b) to support these.
- Place the open-end wrench included in delivery (size 10 mm) on the surfaces (d) and turn the feet of the device (c) upward.
- Roll the centrifuge carefully down from the wooden pallet using the metal rails (b).
- Push the centrifuge to its set-up location.
- Place the open-end wrench included in delivery (size 10 mm) on the surfaces (d) and turn the device feet (c) downward until the castor wheels (f) no longer have contact with the floor.
- Align the centrifuge horizontally by turning the device feet (c).
- Turn the hexagon nuts (e) upward with the open-end wrench included in delivery (size 19 mm) and tighten to secure the position of the device feet (c).

## 8 Delivery checklist

- 1 Power cord
- 1 Single open-end wrench, size 10 mm (for turning the device feet)
- 1 Double open-end wrench, size 17/19 mm (for tightening the hexagon nuts on the device feet)
- 1 Square wrench (for installing and removing the rotor)
- 1 Allen key (to unlock the lid in an emergency)
- 1 Lubricating grease for trunnions
- 1 Tube emptier
- 10 Cover caps (Ø12 mm) for Torx screw heads, size T20
- 1 Operating manual
- 3 Program-data sheets

The rotor(s) and associated accessories are included in the delivery in the quantity ordered.

## 9 Transport and storage

### 9.1 Transport

When the device and accessories are transported, the following ambient conditions must be complied with:

- Ambient temperature: -20°C to +60°C
- Relative humidity: 10% to 80%, non-condensing

### 9.2 Storage



The device and the accessories may only be stored in closed and dry rooms.

When the device and accessories are stored, the following ambient conditions must be complied with:

- Ambient temperature: -20°C to +60°C
- Relative humidity: 10% to 80%, non-condensing

## 10 Initial operation

- A type B residual current circuit breaker must be used if the device is additionally protected with a residual current circuit breaker in the building installation. When using a different type, the residual current circuit breaker may either not switch off the unit if there is a fault on the unit, or it may switch off the unit even though there is no fault on the unit.
- Types 4950-08, 4950-58, 4950-78 and 4950-88: are permanently connected devices. With permanently connected devices, a switch must be fitted in the building installation to disconnect the mains supply to the device, in accordance with the laboratory equipment standard EN / IEC 61010-1. The switch must be located near the device, be readily accessible to the user and be marked as the means of isolation for this device. It must be possible to secure the switch to prevent it being switched on again.
- Types 4950-70, 4950-78, 4950-80 and 4950-88 may only be installed by authorized skilled personnel.



These devices must be installed according to the enclosed set-up and installation instructions, AH4950EN.

- **Position the centrifuge in a stable and level manner in a suitable place. During set-up, the required safety margin of 300 mm around the centrifuge is to be kept according to EN / IEC 61010-2-020.**



**When the centrifuge is running, according to EN / IEC 61010-2-020, no persons, dangerous substances or objects may be within the safety margin of 300 mm around the centrifuge.**

- Ventilation openings may not be blocked.  
A distance of 300 mm must be maintained from the ventilation slots and openings of the centrifuge.
- Centrifuge with PE connector:  
If required, connect the PE connector at the back of the device with an additional medical potential equalization system.
- Centrifuge with optical interface:  
Connect the optical centrifuge interface with a light-conducting cable (not included in the scope of delivery) to the PC.
- Check whether the mains voltage tallies with the statement on the type plate.
- Connect the centrifuge with the power cord to a standard mains socket. For connection ratings refer to Chapter "Technical specification".
- Turn on the mains switch. Switch position "I".  
The following display follows:  
1. Type of centrifuge, 2. The last rotor code detected by the rotor identification and the maximum speed of the rotor (n-max-Rotor), 3. The programme version, 4. **⚡ OPEN ⚡ OEFFNEN**.
- Open the lid.  
The centrifuge data of the last used program or program 1 will be displayed.

## 11 Interface (only for centrifuge with interface)

As an option, the device can be equipped with an optical interface.





The optical interface is labeled with the  symbol.

The centrifuge can be controlled and data queried via this interface.

## 12 Opening and closing the lid



### 12.1 Opening the lid

 The lid can only be opened when the centrifuge is switched on and the rotor is at rest. If it cannot be opened under these circumstances, see the section on “Emergency release”.

- Press the button  on the front panel. The lid unlocks via the motor, the illuminated pushbutton  extinguishes and in the display the symbol  changes to the symbol .

### 12.2 Closing the lid

 Do not put your fingers between lid and housing.  
Do not bang the lid shut.

- Place the lid and slightly press it down at the tubular handle. The locking action is effected by motor. The button  lights up and the symbol  in the display turns to the symbol .

## 13 Installation and removal of the rotor

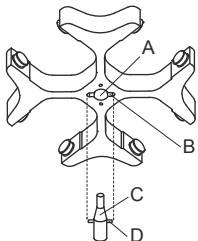

- Clean the motor shaft (C) and the rotor drilling (A), and lightly grease the motor shaft afterwards. Dirt particles between the motor shaft and the rotor hinder a perfect seating of the rotor and cause an irregular operation.
- Place the rotor vertically on the motor shaft. The motor shaft dog (D) has to fit in the rotor slot (B). The alignment of the groove is labelled on the rotor.
- Tighten the rotor tension nut with the supplied wrench by turning in a clockwise direction.
- Check the rotor for firm seating.

 To ensure a tight fit of the rotor, the nut of the rotor must be hand-tightened.

- Loosening the rotor: Loosen the tension nut by turning in a counter clockwise direction, and turning until the working point for lifting. After passing the working point for lifting the rotor is loosened from the motor shaft cone. Turn the tension nut until the rotor is able to be lifted from the motor shaft.



## 14 Inserting and removing hangers into/from the rotor

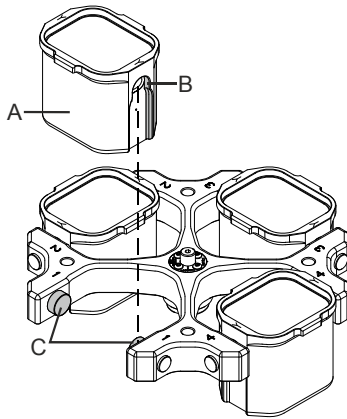

For swing-out rotors, all rotor places must be occupied with the **same** hangers.



Certain hangers are marked with the number of the rotor place. These hangers may only be inserted in the corresponding rotor place.  
Hangers which are labelled with a set number, e.g. S001/4, may only be used in a set.

### Inserting hangers in the rotor:

- Check the rotor to make sure it is seated firmly.
- Grease the lifting lug (C) (Hettich lubricating grease, no. 4051).
- Insert hangers (A) into the rotor. While doing so, make sure that the lifting lugs (C) are in the grooves (B) of the hangers.
- Push the hangers downward as far as they can go.

### Removing hangers from the rotor:

- Pull the hangers (A) straight upward and out of the rotor.

## 15 Inserting and removing the adapters into/from the hangers

### Inserting the adapters into the hangers:

- Insert the adapters (A) horizontally into the hangers (B).

### Remove the adapters from the hangers:

- Remove the adapters (A) upward and out of the hangers (B).

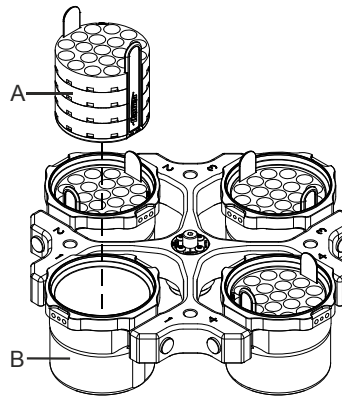
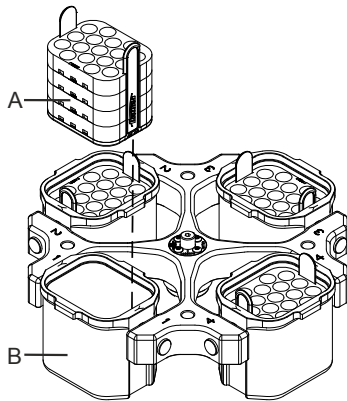

## 16 Loading the rotor



Standard centrifuge containers of glass will not stand RCF values exceeding 4000 (DIN 58970, pg. 2).

- Check the rotor for firm seating.
- With swing-out rotors all rotor positions must be lined with **identical** hangers. Certain hangers are marked with the number of the rotor position. These hangers may only be used in the respective rotor position. Hangers that are marked with a set number (e.g. S001/4) may only be used in the set.
- The rotors and hangers may only be loaded symmetrically. The centrifuge containers have to be distributed evenly on all rotor positions. For authorised combinations see Chapter "Anhang/Appendix, Rotoren und Zubehör/Rotors and accessories".  
In the case of angle rotors all possible rotor positions must be loaded, see chapter "Anhang/Appendix, Rotoren und Zubehör/Rotors and accessories".

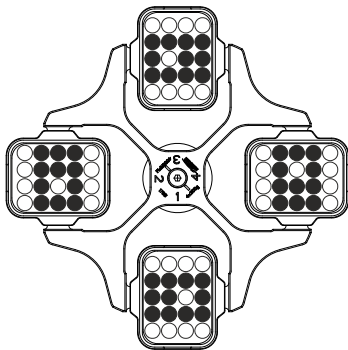

Rotor is loaded symmetrically.

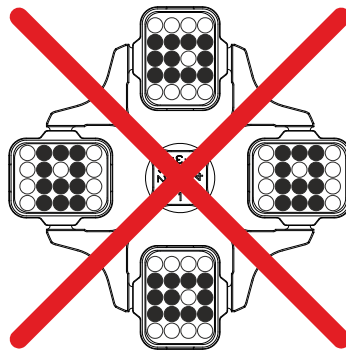

**Not permitted!**  
Rotor is loaded asymmetrically.

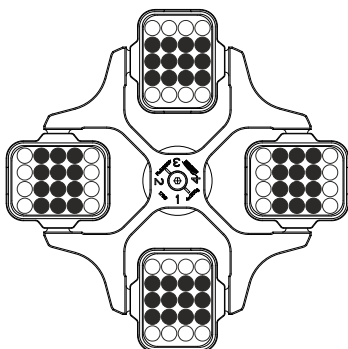

Rotor is evenly loaded

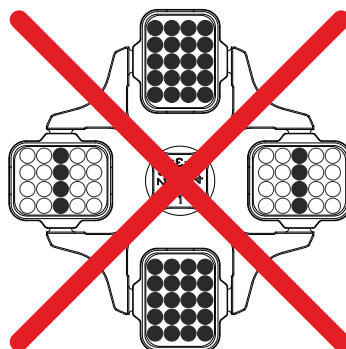

**Not permitted!**  
Rotor is not evenly loaded

- On certain hangers, the weight of the maximum load or the weight of the maximum load and the maximum weight of the completely loaded hanger is specified. This weight may not be exceeded. In case of exception, see chapter "Centrifugation of materials or mixtures of materials with a density higher than 1.2 kg/dm<sup>3</sup>". The weight specification of the maximum load includes the total weight of the adapter, centrifuge container and contents.
- In containers with rubber inserts, the same number of rubber inserts must always be among the centrifuge containers.
- The centrifuge containers may only be filled outside of the centrifuge.

- The maximum filling quantity for the centrifuge containers specified by the manufacturer must not be exceeded. In the case of angle rotors, the centrifuging vessels may only be filled so far that no fluid can be expelled from them while the centrifuge is running.

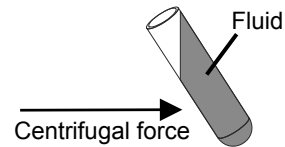

- When loading the angle rotors, no liquid may get into the angle rotors or centrifuging chamber.
- When loading the hangers and swing-out rotors and when swivelling out the hangers while the centrifuge is running, no liquid may enter the hangers or the centrifuging chamber.
- In order to maintain the weight differences within the centrifuge container as marginal as possible, a consistent fill level in the containers is to be heeded.

## 17 Closing biosafety systems



In order to guarantee that it is sealed, the lid to the biosafety system has to be firmly closed.

In order to prevent the packing ring from twisting when opening and closing the cover, the packing ring must be lightly rubbed with a rubber care product.

For further details of available biosafety systems see chapter "Anhang/Appendix, Rotoren und Zubehör/Rotors and accessories". If in doubt, you should obtain relevant information from the manufacturer.

### Lid with screw top and hole in turning handle

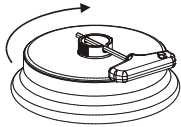

- Place the lid centred on the rotor.
- Insert the supplied key into the hole in the handle and close the lid firmly by turning the key in a clockwise direction.

### Lid with screw closure

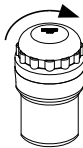

- Place the lid on the hanger.
- Tightly seal the lid by hand by turning it clockwise.

## 18 HettLiner packing instructions

### 18.1 Packing before centrifugation

Note: Make sure that the plastic insert cannot tip over when loading and unloading the inserts (use loading aid 4509).

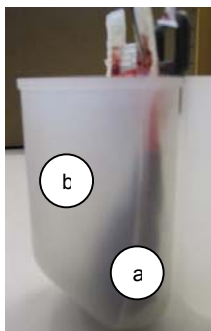

- Insert the blood bag (a) into the insert (b).

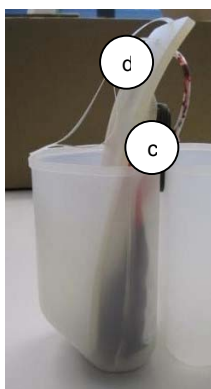
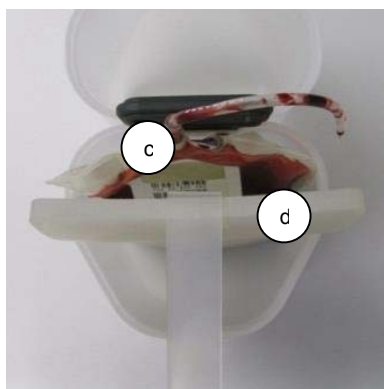

- Hold the blood bag at the connections (c) and push the support plate (d) on the outer side of the blood bag from top to bottom into the insert
- Make sure that the lower edge of the support plate rests as completely as possible on the floor.

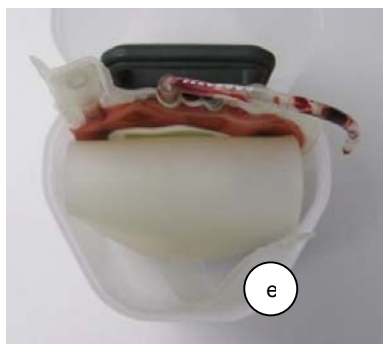

- Fold the support plate outwards and push it down until the folded edge of the support plate is level with the liquid level of the blood bag.
- The position of the loop (e) must be observed so that it can be reached after centrifugation!
- The upper edge of the support plate must not protrude too far from the insert during centrifugation due to the risk of jamming with the rotor arms!

- If available, fold empty satellite bag(s) and pack differently depending on the appropriate accessories and filling volume of the blood bag.  
It is a good idea to fold the satellite bags and pack them on the outside between the folded support plate and the outer wall of the insert.  
→ Make sure that the silicone plate does not slip while doing this!  
→ If necessary, the silicone plate can be held by the loop when packing the satellite bag and thus held against it  
→ The position of the loop must be checked afterwards!
- Place the connections over the support plate so that the valves cannot break.  
Make sure the tubes do not protrude from the insert!  
→ Stow tube sections protruding over the edge of the insert between the folded down support plate and the insert wall.
- Balance weights should be placed between the folded down support plate and the bucket wall if needed.

## 18.2 Unpacking after centrifugation

- Pull the satellite bag out of the insert while holding the silicone plate in place with one hand.
- Slowly pull out the folded part of the support plate at the loop provided!  
→ Caution: Carefully return the support plate to its original shape!  
→ The folded part of the support plate can spring back and mix blood components.
- Remove the remaining blood bag from the insert either together with the support plate or after removing the support plate!

## 19 Control and display devices

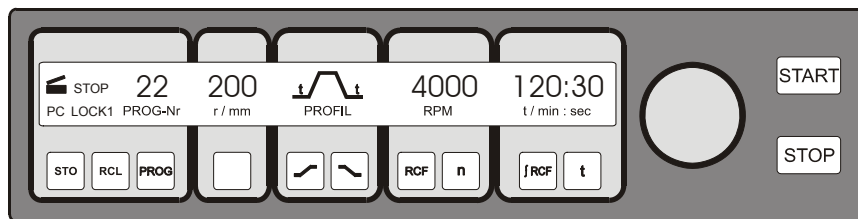

### 19.1 Status symbols



Lid open.



Lid closed.



Rotation indicator. The indication appears while the centrifuge is running as long as the rotor is turning.

**STOP**

Centrifugation run stopped or finished. Indication after completion of the centrifugation run as long as the rotor is turning. The indicator flashes following an emergency stop.

**LOCK 1,  
LOCK 2**

Keyswitch position.

**LOCK 4,  
LOCK 5**

Program interlocking when serial communication provided (for centrifuges with serial communication only).

**PC, ~~PE~~**

Serial communication (for centrifuges with serial communication only).

Operating errors or faults that occur are shown symbolically in the display (see Chapter "Faults").

### 19.2 Control knob



For setting the individual parameters.

Turning anticlockwise reduces the value. Turning clockwise increases the value.

### 19.3 Keys and set-up options



Running time, parameter t/min:sec

1. Parameter t/min: Adjustable from 1 - 999 min, in 1 min steps.
2. Parameter t/:sec Adjustable from 1 - 59 s, in 1 second steps.
3. Continuous running "---:--"



Interrogation of the integral RCF, parameter JRCF.



1. Speed, parameter RPM

A numerical value from 50 RPM up to the maximum speed of the rotor (n-max-Rotor) can be set. Maximum speed of the rotor, see Chapter "Anhang/Appendix, Rotoren und Zubehör/Rotors and accessories". Adjustable in steps of 10.

2. Interrogation of the maximum speed of the rotor, parameter n-max-Rotor.



1. Relative centrifugal force, parameter RCF/RZB

A numerical value can be set, which gives a speed between 50 RPM and the maximum speed of the rotor (n-max-Rotor). Adjustable in steps of 1.

2. Interrogation of the maximum RCF of the rotor, parameter RCF-max-Rotor.



Run-up parameters

1. Run-up steps, parameter  $\curvearrowright_{1-9}$ . Step 9 = shortest run-up time, ... Step 1 = longest run-up time.
2. Run-up time, parameter  $\curvearrowright_{\text{min:sec}}$ . The time range that can be set is dependent upon the set speed.



Run-down parameters

1. Braking steps, parameter  $\curvearrowleft_{0-9}$ . R = linear braking curve, B = similar to an exponential braking curve. Step R9, B9 = short run-down time, ... Step R1, B1 = long run-down time, Step R0 = unbraked run-down.
2. Run-down time, parameter  $\curvearrowleft_{\text{min:sec}}$ . The time range that can be set is dependent upon the set speed.
3. Brake de-energisation speed, parameter  $n^{(*)}$ /RPM  
After reaching this speed, unbraked run-down occurs.



1. Temperature setpoint, parameter T/°C. Adjustable from -20°C to +40°C, in 1°C steps (heating/cooling option settable between -20°C and +60°C). The lowest temperature that can be achieved is dependent upon the rotor (see Chapter "Anhang/Appendix, Rotoren und Zubehör/Rotors and accessories").
2. Centrifuging radius, parameter r/mm. Entry in mm. Centrifuging radius, see Chapter "Anhang/Appendix, Rotoren und Zubehör/Rotors and accessories".



- START 1. Start centrifugation run. The rotation indicator  appears.  
2. Acceptance of changes during the centrifugation run.
- STOP Stop centrifugation run.  
The rotor decelerates with the preset run-down parameters. Pressing the key twice will initiate an emergency stop.
- PROG Select program location, parameter PROG-Nr.
- RCL Calling up of programs.
- STO Saving of programs.  
89 programs can be saved (program locations 1 to 89). Note: The program locations "----" and 90 to 99 are used as automatic buffers (see Chapter "Automatic buffer"). No programs can be saved in these program locations.

## 20 Entering centrifugation parameters

 It is only possible to enter a parameter when the input field is displayed inversely (dark background). An inverse input field will go off automatically after 10 seconds.

### 20.1 Running time

#### 20.1.1 Time selection

- Press the  key repeatedly until the parameter t/min: or t/ :sec is displayed. The input field will be displayed inversely.
- Set the desired value by means of the control knob .



#### 20.1.2 Continuous running

- Select the parameters t/min: and t/ :sec one after the other (see Chapter "Time selection"), and set both to zero using the control knob . "---:--" will be displayed in the input field.

### 20.2 Speed (RPM)

- Press the  key repeatedly until the parameter RPM is displayed and the input field is shown inversely.
- Set the desired value by means of the control knob .

### 20.3 Relative centrifugal force (RCF/RZB)

- Press the  key repeatedly until the parameter RCF/RZB is displayed and the input field is shown inversely.
- Set the desired value by means of the control knob .

The centrifuging radius indicator will flash while the adjustment is being made.

### 20.4 Run-up and run-down parameters





The run-up and run-down parameters that have been set are displayed.





x: 1-9 = run-up step, t = run-up time

y: R1-R9, B1-B9 = braking step, R0 = unbraked run-down, t = run-down time, n<sup>(\*)</sup> = brake de-energisation speed

#### 20.4.1 Run-up step

- Press the  key repeatedly until the parameter <sub>1-9</sub> or  is displayed. The input field will be displayed inversely.
- Set the desired step by means of the control knob .

#### 20.4.2 Run-up time

- Press the  key repeatedly until the parameter <sup>min:sec</sup> is displayed. The input field will be displayed inversely.
- Set the desired value by means of the control knob .

If a run-up time is set that is longer than the running time, the centrifugation run will end before the set speed is reached.

### 20.4.3 Braking step

- Press the  $\square$  key repeatedly until the parameter  $\backslash_{0-9}$  or  $\backslash$  is displayed. The input field will be displayed inversely.
- Set the desired step by means of the control knob  $\odot$ .

B-braking steps can only be set for special rotors.

### 20.4.4 Run-down time

If a brake de-energisation speed has been set, it is not possible to set a run-down time.

- Press the  $\square$  key repeatedly until the parameter  $\backslash_{\text{min:sec}}$  is displayed. The input field will be displayed inversely.
- Set the desired value by means of the control knob  $\odot$ .

### 20.4.5 Brake de-energisation speed

- Press the  $\square$  key repeatedly until the parameter  $n^{(+)}/\text{RPM}$  is displayed. The input field will be displayed inversely.
- Set the desired value by means of the control knob  $\odot$ .

## 20.5 Radius/Temperature

### 20.5.1 Radius

- Press the  $\square$  key repeatedly until the parameter  $r/\text{mm}$  is displayed and the input field is shown inversely.
- Set the desired value by means of the control knob  $\odot$ .

The value of the RCF/RZB adapts automatically when the radius is changed; this is shown by the indication flashing.

### 20.5.2 Temperature

- Press the  $\square$  key repeatedly until the parameter  $T/^\circ\text{C}$  is displayed and the input field is shown inversely.
- Set the desired value by means of the control knob  $\odot$ .

## 20.6 Automatic buffer

The buffer comprises the program locations "----" and 90 to 99. Every time a centrifugation run is started, modified centrifugation data are automatically stored in program location "----". The modified centrifugation data for the last 11 centrifugation runs are stored in the buffer and can be called up (see Chapter "Calling up programs").

## 21 Programming

### 21.1 Entering / modifying programs

- Set the desired parameters (see Chapter "Entering centrifugation parameters").
- Press the  $\text{PROG}$  key in order to select the parameter PROG-Nr. The input field will be displayed inversely.
- Set the desired program location by means of the control knob  $\odot$ .  
If the program location indicator flashes, then this program location has already had centrifugation data assigned to it. In this case, set a free program location or overwrite the centrifugation data by continuing.
- Press the  $\text{STO}$  key once to save the settings in the desired program location.  
Press the  $\text{STO}$  key twice to overwrite centrifugation data already stored.

### 21.2 Calling up programs

- Press the  $\text{PROG}$  key in order to select the parameter PROG-Nr. The input field will be displayed inversely.
- Set the desired program location by means of the control knob  $\odot$ .
- Press the  $\text{RCL}$  key. The centrifugation data for the selected program location will be displayed.



## 22 Centrifugation



When the centrifuge is running, according to EN / IEC 61010-2-020, no persons, dangerous substances or objects may be within the safety margin of 300 mm around the centrifuge.



If the permissible weight difference within the rotor loading has been exceeded, the drive shuts down during the start-up, and **IMBALANCE / UNWUCHT** is displayed.

If the speed in the selected program is higher than the maximum speed of the rotor (n-max-Rotor), it will not be possible to start a centrifugation run. The message **N > ROTOR MAX 96** will be displayed (see Chapter "Faults").

A centrifugation run can be stopped at any time by pushing the key **STOP**.



It is possible to switch over between RPM and RCF display at any time using the **RPM** and **RCF** keys. When working with the RCF display, it is necessary to enter the centrifuging radius.

If **OPEN** is displayed, a further operation of the centrifuge is only possible after opening the lid once.

If **R xx n-max xxxxx** is displayed, then no centrifugation run has taken place as the rotor was changed beforehand, refer to Chapter "Rotor Identification".



- Switch on the mains supply switch. Switch position I.
- Load the rotor and close the centrifuge lid.

### 22.1 Centrifugation with time selection

- Set the time or call up a program with a pre-set time (see Chapter "Entering centrifugation parameters" or "Calling up programs").
- Press the **START** key. The rotation indicator  will appear as long as the rotor is turning.
- When the time has expired or if the centrifugation run is interrupted by pressing the **STOP** key, run-down will take place with the selected run-down parameters. When the rotor comes to a stop, the  symbol will flash in the display until the lid is opened.

During the centrifugation run, the rotor speed or the RCF value, the temperature in the centrifuging chamber, and the remaining time are displayed.

### 22.2 Continuous running

- Select the  symbol or call up a continuous running program (see Chapter "Entering centrifugation parameters" or "Calling up programs").
- Press the **START** key. The rotation indicator  will appear as long as the rotor is turning. The time count starts from 00:00.
- Press the **STOP** key to stop the centrifugation run. Run-down will take place with the selected run-down parameters. When the rotor comes to a stop, the  symbol will flash in the display until the lid is opened.

During the centrifugation run, the rotor speed or the RCF value, the temperature in the centrifuging chamber, and the elapsed time are displayed.

## 23 Changing settings during the centrifugation run.

The running time, the speed, the relative centrifugal force (RCF/RZB), the run-up and run-down parameters as well as the temperature can be changed while the centrifuge is running.

The parameters can only be changed one at a time and in succession.

- Select the desired parameter and change the value using the control knob  (see Chapter "Entering centrifugation parameters").
- Press the **START** key. The modified setting will be stored in program location "----" (see Chapter "Automatic buffer"). The original program will not be overwritten.

## 24 Integral RCF (∫RCF)

The integral RCF (∫RCF) is a measure for the sedimentation effect ( $\int n^2 dt$ ). This numerical value is used to compare centrifugation runs. To interrogate the integral RCF, press and hold the **∫RCF** key.

## 25 Displaying the maximum speed of the rotor

- Press the **RPM** key repeatedly until the parameter RPM is displayed and the input field is shown inversely.
- Press the **RPM** key once more and hold it pressed; the maximum speed of the rotor (n-max-Rotor) will be displayed.

## 26 Displaying the maximum RCF of the rotor

- Press the **[RCF]** key repeatedly until the parameter RCF/RZB is displayed and the input field is shown inversely.
- Press the **[RCF]** key once more and hold it pressed; the maximum RCF of the rotor (RCF-max-Rotor) will be displayed.

## 27 Emergency stop

- Press the **[STOP]** key twice. The **STOP** symbol will flash in the display.

In the case of an emergency stop, run-down takes place with braking step R9 (shortest run-down time). If braking step R0 was selected, the run-down time will be longer than with braking step R9 for technical reasons.

## 28 Audible signal

The audible signal sounds in accordance with the following philosophy:

<b>OFF</b>	<ul style="list-style-type: none"> <li>• at 2 s intervals on the occurrence of a fault</li> </ul>
<b>ON1</b>	<ul style="list-style-type: none"> <li>• at 2 s intervals on the occurrence of a fault</li> <li>• at 30 s intervals on completion of a centrifugation run and the rotor coming to rest.</li> </ul>
<b>ON2</b>	<ul style="list-style-type: none"> <li>• at 2 s intervals on the occurrence of a fault</li> <li>• at 30 s intervals on completion of a centrifugation run and the rotor coming to rest.</li> <li>• every time a key is pressed</li> </ul>

The audible signal is silenced by opening the lid or pressing any key.

The signal can be set as follows when the rotor is at standstill.

- Open the lid.
- Press and hold the **[t]** key for 8 seconds.  
After 8 seconds **SOUND / BELL XXX** will be displayed.
- Set the desired function (OFF, ON1, ON2) by means of the control knob **○**.
- Press the **[START]** key to save the setting.  
**\*\*\* ok \*\*\*** will be displayed briefly as a confirmation.

## 29 Interrogating the operating hours

It is only possible to interrogate the operating hours when the rotor is at standstill.

- Open the lid.
- Press and hold the **[t]** key for 8 seconds.  
After 8 seconds **SOUND / BELL XXX** will be displayed.
- Press the **[t]** key once more.  
The operating hours (**CONTROL:** ) for the centrifuge will be displayed.  
The operating hours display will go off automatically after 10 seconds.

## 30 Setting the date and time

It is only possible to set the date and time when the rotor is at standstill.

- Open the lid.
- Press and hold the **[t]** key for 8 seconds.  
After 8 seconds **SOUND / BELL XXX** will be displayed.
- Press the **[t]** key twice more.  
The date and time will be displayed (a: year, mon: month, d: day, h: hours, min: minutes).
- Press the **[ ]** key repeatedly until the input field for the desired parameter is shown inversely.
- Set the desired value by means of the control knob **○**.
- Press the **[START]** key to save the setting.  
**\*\*\* ok \*\*\*** will be displayed briefly as a confirmation.
- To exit the date and time set-up, press any key apart from the **[ ]**, **[t]** and **[START]** keys.

## 31 Centrifugation data displayed after switching on.

After switching on, the centrifugation data for program 1 or for the program last used will be displayed. This can be set as follows:

- Open the lid.
- Switch the mains supply switch off and on again. Switch position I.
- Press the **[STOP]** key when the first visual change appears in the display (inverse display).  
**PROGRAM 1, LAST PROGRAM** will be displayed.
- Set the desired function by means of the control knob **○**.
- Press the **[START]** key to save the setting.  
**\*\*\* ok \*\*\*** will be displayed briefly as a confirmation.

### 32 Immediate display of the centrifugation data after switching on

- Switch on the mains supply switch. Switch position I.
- Press any key apart from the **STOP** key when the first visual change appears in the display (inverse display). The centrifugation data will be displayed immediately.

### 33 Key-operated switch.

The following program interlocks can be set by the key-operated switch:

Left key position: **LOCK 1** will be displayed.

Programs can be called up but not changed.

Right key position: **LOCK 2** will be displayed.

No programs can be called up or changed.

Middle key position: no status display.

No program interlock. Programs can be called up and changed.

### 34 Program linking (for centrifuges with program linking only).

Several centrifugation runs can be linked together with the help of the program linking function.

#### 34.1 Linking programs



Program linking is only possible with programs in which run-up and braking steps have been set.

Before linking, the programs must be stored in the desired sequence either by entering the program or by calling up the program (see Chapter "Programming").

The program locations must be consecutive (e.g. program locations 10+11+12).

1. Press the **PROG** key in order to select the parameter PROG-Nr. The input field will be displayed inversely.
2. Set the program location for the first program (XX+) by means of the control knob  $\odot$ .
3. Press the **RCL** key. The centrifugation data for the selected program location will be displayed.
4. Press the **PROG** key twice in order to select the parameter PR-PART. The input field will be displayed inversely.
5. Press the **STO** key twice. The program will be linked and the program number for the next program location (+XX+) will be displayed.
6. Press the **RCL** key twice. The centrifugation data for the selected program location will be displayed.
7. Press the **STO** key twice. The program will be linked and the program number for the next program location (+XX+) will be displayed.
8. Keep repeating steps 6 and 7 until all programs have been linked.
9. Press the **PROG** key to exit. The program number for the last program (+XX) will be displayed.

#### 34.2 Changing program links

- Call up the desired program (see Chapter "Calling up programs"), change the desired parameters (see Chapter "Entering centrifugation parameters"), and save the modified centrifugation data to the same program location (see Chapter "Entering / modifying programs"). As a result of saving, the program linking will be removed.
- Re-link the programs (see Chapter "Linking programs").

### 34.3 Centrifugation run with program linking

- Press the **PROG** key twice in order to select the parameter PR-PART. The input field will be displayed inversely.
- Set the program location for the first program (XX+) by means of the control knob  $\odot$ .
- Press the **RCL** key. The centrifugation data for the selected program location will be displayed.
- Press the **START** key. The rotation indicator  $\odot$  will appear as long as the rotor is turning.



First program (XX+)  
**x**: Run-up step for the first program



Next program (+XX+)  
**x**: Run-up step for the next program



Last program (+XX)  
**x**: Run-up step for the last program  
**y**: Braking step for the last program

- When the time in the last program has expired, run-down will take place with the braking step of the last program. If the centrifugation run is interrupted by pressing the **STOP** key, run-down will take place with the braking step of the program running at the time.

### 34.4 Deleting program linking

- Press the **PROG** key in order to display the parameter PROG-Nr. The input field will be displayed inversely.
- Set the program location for the first program (XX+) by means of the control knob  $\odot$ .
- Press the **RCL** key. The centrifugation data for the selected program location will be displayed.
- Press the **PROG** key twice in order to display the parameter PR-PART. The input field will be displayed inversely.
- Press the **STO** key twice.
- Press the **PROG** key.

## 35 Cooling

The temperature set-point can be adjusted from -20°C to +40°C. On centrifuges with a heating/cooling option, the temperature set-point is settable from -20°C to +60°C. The lowest obtainable temperature is dependent on the rotor (see Chapter "Anhang/Appendix, Rotoren und Zubehör/Rotors and accessories"). If the actual temperature and the set temperature deviate more than 5 °C, the temperature value in the display will start to flash on and off.

### 35.1 Standby-cooling

With rotor standstill and closed lid the centrifugal chamber is cooled to the pre-selected temperature. The temperature set-point is shown in the display.

### 35.2 Pre-cooling the rotor

For rapid pre-cooling of the unloaded rotor and the accessories, it is recommended that the centrifuge is run with the continuous running settings and a speed of ca. 20% of the maximum rotor speed.

## 36 Heating

During operation of the centrifuge the centrifuge chamber can be heated as required to the preselected temperature. The heating is switched off when the rotor is stationary.



Risk of burning! The surface temperature of the heating element in the centrifugal chamber of the centrifuge can reach 500°C / 932°F. Do not touch the heating element.

### 37 Relative centrifugal force (RCF)

The relative centrifugal force (RCF) is given as a multiple of the acceleration of gravity (g). It is a unit-free value and serves to compare the separation and sedimentation performance.

These values are calculated using the formula below:

$$\text{RCF} = \left( \frac{\text{RPM}}{1000} \right)^2 \times r \times 1,118 \quad \Rightarrow \quad \text{RPM} = \sqrt{\frac{\text{RCF}}{r \times 1,118}} \times 1000$$

RCF = relative centrifugal force

RPM = rotational speed (revolutions per minute)

r = centrifugal radius in mm = distance from the centre of the turning axis to the bottom of the centrifuge container. For more on the centrifugal radius see the chapter "Anhang/Appendix, Rotoren und Zubehör/Rotors and accessories".



The relative centrifugal force (RCF) stands in relation to the revolutions per minute and the centrifugal radius.

### 38 Centrifugation of materials or mixtures of materials with a density higher than 1.2 kg/dm<sup>3</sup>

When centrifuging with maximum revolutions per minute the density of the materials or the material mixtures may not exceed 1.2 kg/dm<sup>3</sup>.

The speed must be reduced for materials or mixtures of materials with a higher density.

The permissible speed can be calculated using the following formula:

$$\text{Reduced speed } (n_{\text{red}}) = \sqrt{\frac{1.2}{\text{Greater density [kg/dm}^3]}} \times \text{maximum speed [RPM]}$$

e.g.: maximum speed RPM 4000, density 1.6 kg/dm<sup>3</sup>

$$n_{\text{red}} = \sqrt{\frac{1.2 \text{ kg/dm}^3}{1.6 \text{ kg/dm}^3}} \times 4000 \text{ RPM} = 3464 \text{ RPM}$$

In the exceptional case that the maximum loading indicated on the hanger is exceeded, the speed must also be reduced.

The permissible speed can be calculated using the following formula:

$$\text{Reduced speed } (n_{\text{red}}) = \sqrt{\frac{\text{maximum load [g]}}{\text{actual load [g]}}} \times \text{maximum speed [RPM]}$$

e.g.: maximum speed RPM 4000, maximum load 300 g, actual load 350 g

$$n_{\text{red}} = \sqrt{\frac{300 \text{ g}}{350 \text{ g}}} \times 4000 \text{ RPM} = 3703 \text{ RPM}$$

If in doubt you should obtain clarification from the manufacturer.

### 39 Rotor recognition

Rotor recognition is carried out after each start of the centrifugation run.

If the rotor has been changed, the centrifugation run is canceled after rotor recognition. The rotor code (R xx) and the maximum speed (n-max=xxxxx) of the rotor are displayed.



A further operation of the centrifuge is only possible after a single opening of the lid.

If the maximum speed of the rotor being used is less than the set speed, the speed is limited to the rotor's maximum speed.

## 40 Emergency release

During a power failure the lid cannot be unlocked by motor. An emergency release has to be executed by hand.



For emergency release disconnect the centrifuge from the mains. In the case of permanently connected devices, switch off the mains switch to disconnect the mains supply of the device in the building installation and secure it against being switched on again, e.g. by locking the switch.

Open the lid only during rotor standstill.

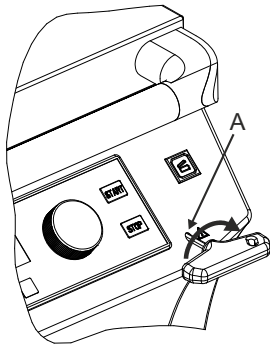

- Switch off the mains switch (switch setting "0").
- Look through the window in the lid to be sure that the rotor has come to a standstill.
- Insert the hexagon socket head wrench horizontally into the drilling (A) and carefully rotate by half a turn in clockwise direction until the lid can be opened.
- Pull the hexagon socket head wrench out of the drilling again.
- After turning the centrifuge on again, press the button  so that the motor-driven lid locking once again assumes the normal position (opened).

## 41 Maintenance and servicing



The device can be contaminated.



Pull the mains plug before cleaning. In the case of permanently connected devices, switch off the mains switch to disconnect the mains supply of the device in the building installation and secure it against being switched on again, e.g. by locking the switch.

Before any other cleaning or decontamination process other than that recommended by the manufacturer is applied, the user has to check with the manufacturer that the planned process does not damage the device.

- Centrifuges, rotors and accessories must not be cleaned in rinsing machines.
- They may only be cleaned by hand and disinfected with liquids.
- The water temperature must be between 20 – 25°C.
- Only detergents/disinfectants may be used which:
  - have a pH between 5 - 8
  - do not contain caustic alkalis, peroxides, chlorine compounds, acids and alkaline solutions
- In order to prevent appearances of corrosion through cleaning agents or disinfectants, the application guide from the manufacturer of the cleaning agent or disinfectant are absolutely to be heeded.

### 41.1 Centrifuge (housing, lid and centrifuging chamber)

#### 41.1.1 Surface cleaning and care

- Clean the centrifuge housing and the centrifuging chamber regularly, using soap or a mild detergent and a damp cloth if required. For one thing, this services purposes of hygiene, and it also prevents corrosion through adhering impurities.
- Ingredients of suitable detergents: soap, anionic tensides, non-ionic tensides.
- After using detergents, remove the detergent residue by wiping with a damp cloth.
- The surfaces must be dried immediately after cleaning.
- In the event of condensation water formation, dry the centrifugal chamber by wiping out with an absorbent cloth.
- Lightly rub the rubber seal of the centrifuge chamber with a rubber care product after each cleaning.
- The centrifuging chamber is to be checked for damage once a year.



If damage is found which is relevant to safety, the centrifuge may no longer be put into operation. In this case, notify Customer Service.

#### 41.1.2 Surface disinfection

- If infectious materials penetrates into the centrifugal chamber this is to be disinfected immediately.
- Ingredients of suitable disinfectants:  
ethanol, n-propanol, ethyl hexanol, anionic tensides, corrosion inhibitors.
- After using disinfectants, remove the disinfectant residue by wiping with a damp cloth.
- The surfaces must be dried immediately after disinfecting.

#### 41.1.3 Removal of radioactive contaminants

- The agent must be specifically labelled as being an agent for removing radioactive contaminants.
- Ingredients of suitable agents for removing radioactive contaminants:  
anionic tensides, non-ionic tensides, polyhydrated ethanol.
- After removing the radioactive contaminants, remove the agent residue by wiping with a damp cloth.
- The surfaces must be dried directly after removing the radioactive contaminants.

### 41.2 Rotors and Attachments

#### 41.2.1 Cleaning and care

- In order to avoid corrosion and changes in materials, the rotors and accessories have to be cleaned regularly with soap or with a mild cleaning agent and a moist cloth. Cleaning is recommended at least once a week. Contaminants must be removed immediately.
- Ingredients of suitable detergents:  
soap, anionic tensides, non-ionic tensides.
- After using detergents, remove detergent residue by rinsing with water (only outside of the centrifuge) or wipe off with a damp cloth.
- The rotors and accessories must be dried directly after cleaning.
- Angle rotors, container and hanger made of aluminium are to be lightly greased after drying using acid-free grease, e.g. vaseline.
- The sealing rings of bio-safety systems must be cleaned weekly.  
The sealing rings are made of silicone. To guarantee the leak-tightness of the bio-safety systems, the sealing rings must not be handled with talcum powder after cleaning or autoclaving.  
Each time before using the bio-safety system, all parts of the bio-safety system must be visually inspected for damage. In addition, the sealing ring(s) of the bio-safety system must be checked to make sure they are in the correct installation position.  
Damaged parts of the bio-safety system must be exchanged immediately.  
If there are signs of crack formation, brittleness or wear, immediately replace the sealing ring in question. In the case of lids with sealing rings which cannot be replaced, the entire lid must be exchanged.  
For the available bio-safety systems, see the chapter "Appendix, Rotors and accessories".
- In order to prevent corrosion as a result of moisture between the rotor and the motor shaft, the rotor should be disassembled and cleaned at least once a month, and the motor shaft should be lightly greased.
- The rotors and accessories have to be checked weekly for wear and corrosion. For swing-out rotors, it is important to check the area of the lifting lugs, for hangers, the grooves and the base should be checked for cracks.

Example: Crack in the groove area:

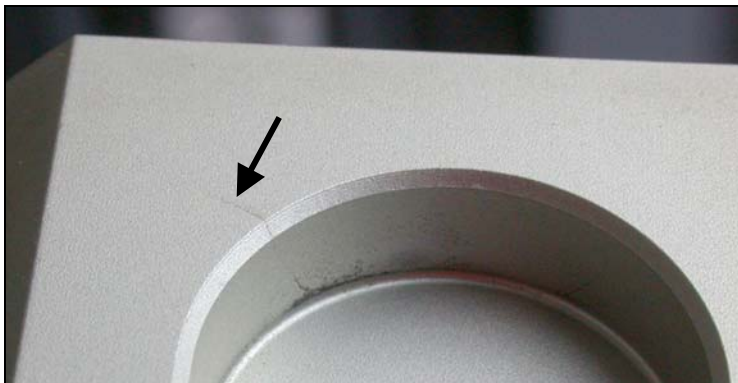

Rotors and attachments may no longer be utilised upon indication of wear and tear or corrosion.

- Check the firm seating of the rotor on a weekly basis.

### 41.2.2 Disinfection

- If infectious material should get on the rotors or accessories, they must be appropriately disinfected.
- Ingredients of suitable disinfectants:  
ethanol, n-propanol, ethyl hexanol, anionic tensides, corrosion inhibitors.
- After using disinfectants, remove disinfectant residue by rinsing with water (only outside of the centrifuge) or wipe off with a damp cloth.
- The rotors and accessories must be dried directly after disinfection.

### 41.2.3 Removal of radioactive contaminants

- The agent must be specifically labelled as being an agent for the removal of radioactive contaminants.
- Ingredients of suitable agents for removing radioactive contaminants:  
anionic tensides, non-ionic tensides, polyhydrated ethanol.
- After removing the radioactive contaminants, remove agent residue by rinsing with water (only outside of the centrifuge) or wipe off with a damp cloth.
- The rotors and accessories must be dried directly after removing the radioactive contaminants.

### 41.2.4 Trunnions

With swing-out rotors the trunnions must be regularly lubricated (Hettich Lubricating Grease No. 4051) in order to ensure consistent swinging out of the hangers.

### 41.2.5 Rotors and accessories with limited service lives

The use of certain rotors, hangers and accessory parts is limited by time.

These are marked with the maximum permitted number of operating cycles or with an expiration date and the maximum permitted number of operating cycles or just with the expiration date; e.g.:

- "einsetzbar bis Ende: IV. Quartal 2011 / usable until end of: IV. Quarter 2011" or  
"einsetzbar bis Ende Monat/Jahr: 10/2011 / usable until end of month/year: 10/2011"
- "Max. Lauf Zyklen / max. cycles: 40000".



For safety reasons, rotors, hangers and accessory parts may no longer be used if either the indicated maximum number of operating cycles or the indicated expiration date has been reached.

### 41.2.6 Calculation of the number of run cycles carried out

To calculate the number of carried out run cycles (centrifugation runs), the run-time per centrifugation run and the operating hours of the device are required.

To query the operating hours, see the chapter "Operating hours query".

If centrifugation runs were carried out with different run-times, the shortest run-time is to be used for the calculation.

The number of carried out run cycles (centrifugation runs) are calculated as follows:

Number of executed running cycles = operating hours [h] x 60 ÷ run-time [min]

e.g.: Operating hours 2000 h, run-time 5 min

Number of executed running cycles = 2000 x 60 ÷ 5 = 24000



### 41.3 Autoclaving

The following accessories may be autoclaved at 121°C / 250°F (20 min):

- Swing-out rotors
- Angle rotors made of aluminium
- Hangers made of metal
- Lid with bio-seal
- Adapter

Nothing definitive can be said about the degree of sterility.



The lids of the rotors and containers must be removed before autoclaving.

Autoclaving accelerates the ageing process of plastics. In addition, it can cause discolourations in plastics.

After autoclaving, the rotors and the accessories must be visually inspected for damage and any damaged parts must be exchanged immediately.

If there are signs of crack formation, brittleness or wear, immediately replace the sealing ring in question.

In the case of lids with sealing rings which cannot be replaced, the entire lid must be exchanged.

To guarantee the leak-tightness of the bio-safety systems, the sealing rings must not be handled with talcum powder after autoclaving.

### 41.4 Centrifuge containers

- With leakiness or after the breakage of centrifuging containers broken container parts, glass splinters and leaked centrifugation material are to be completely removed.
- The rubber inserts as well as the plastic sleeves of the rotors are to be replaced after a glass breakage.



Remaining glass splinters cause further glass breakage!

- If this concerns infectious material, a disinfection process is to be executed immediately.

## 42 Faults

If the fault cannot be eliminated with the help of the fault table, please inform Customer Service.

Please specify the type of centrifuge and the serial number. Both numbers can be found on the name plate of the centrifuge.

-  Perform a MAINS RESET:
- Switch off the mains switch (switch position "0").
  - Wait at least 10 seconds and then switch on the mains switch again (switch position "I").

Message / fault		Cause	Remedy
No display	---	No voltage. Overvoltage protection tripped out.	<ul style="list-style-type: none"> <li>- Check supply voltage.</li> <li>- Mains switch ON.</li> </ul>
TACHO - ERROR	01	Faulty speedometer.	<ul style="list-style-type: none"> <li>- Open the cover.</li> <li>- Switch off the mains switch (switch position "0").</li> <li>- Wait at least 10 seconds.</li> <li>- Turn the rotor vigorously by hand.</li> <li>- Switch on the mains switch again (switch position "I"). The rotor must turn during switch-on.</li> </ul>
	02	No rotor installed. Defective motor, frequency converter or drive.	
IMBALANCE / UNWUCHT	---	The rotor is unevenly loaded.	<ul style="list-style-type: none"> <li>- Open lid.</li> <li>- Check the loading of the rotor, see chapter "Loading the rotor".</li> <li>- Repeat the centrifugation run.</li> </ul>
CONTROL - ERROR	04, 06 - 09	Error in lid locking or lid closure.	<ul style="list-style-type: none"> <li>- Perform a MAINS RESET.</li> </ul>
N > MAX	05	Rotation too fast	
N < MIN	13	Rotation too slow	
ROTORCODE	10	Incorrect rotor coding	
MAINS INTERRUPT	---	Power failure during the centrifugation run. (The centrifugation run was not finished.)	<ul style="list-style-type: none"> <li>- Open lid.</li> <li>- Push <b>START</b> button.</li> <li>- Repeat the centrifugation run if necessary.</li> </ul>
VERSIONS-ERROR	12	Mismatch between electronic components	<ul style="list-style-type: none"> <li>- Perform a MAINS RESET.</li> </ul>
SER I/O - ERROR	30 - 38	Error / defective interface	
° C * - ERROR	50 - 56, 58	Error / defective cooling	
LOCK - ERROR	57	Error / defective program locking	
FU / CCI - ERROR	60 - 83	Error / defective motor control	
CONTROL-ERROR	26, 90 - 95, 97 - 99	Error / defective control unit	
N > ROTOR-MAX	96	Speed in the selected program greater than the maximum speed of the rotor (n-max-Rotor).	<ul style="list-style-type: none"> <li>- Check the set speed.</li> <li>- Reduce the set speed</li> </ul>
		The rotor has been changed. The maximum speed of the installed rotor is higher than that of the rotor that was previously used and this has not yet been detected by rotor recognition.	<ul style="list-style-type: none"> <li>- Set a speed up to the maximum speed of the rotor that was previously used. Press the <b>START</b> key to run rotor recognition. See chapter, "Rotor Recognition".</li> </ul>

### 43 Returning Devices

If the device or its accessories are returned to Andreas Hettich GmbH & Co. KG, in order to provide protection for people, the environment and materials, it has to be decontaminated and cleaned before being shipped.

We reserve the right to refuse contaminated devices or accessories.

Costs incurred for cleaning and disinfection are to be charged to the customer.

We ask for your understanding in this matter.

### 44 Disposal



**The device can be disposed of via the manufacturer.**

A Return Material Authorisation (RMA) form must always be requested for a return.

If necessary, contact the Technical Service Department of the manufacturer:

Andreas Hettich GmbH & Co. KG

Föhrenstrasse 12

78532 Tuttlingen, Germany

Phone: +49 7461 705 1400

Email: [service@hettichlab.com](mailto:service@hettichlab.com)

Disposal costs may be incurred.



**WARNING**

**Risk of pollution and contamination for people and the environment.**

When disposing of the centrifuge, people and the environment may be polluted or contaminated by incorrect or improper disposal.

- Removal and disposal may be carried out only by a trained and authorized service personnel.

The device is intended for the commercial sector ("Business to Business" - B2B).

According to Directive 2012/19/EU, the devices may no longer be disposed of with household waste.

The appliances are assigned to the following groups according to the Stiftung Elektro-Altgeräte Register (EAR (German foundation under civil law)):

- Group 1 (heat exchangers)



The crossed-out bin symbol indicates that the device must not be disposed of with household waste.

Regulations governing disposal of such devices may differ in individual countries. If necessary, contact the supplier.

**Table des matières**

1	Utilisation de ce mode d'emploi .....	79
2	Signification des symboles .....	79
3	Utilisation conforme .....	80
4	Risques résiduels .....	80
5	Données techniques .....	81
6	Consignes de sécurité .....	83
7	Déballage et installation de la centrifugeuse .....	85
8	Composition de la livraison .....	85
9	Transport et stockage .....	86
9.1	Transport .....	86
9.2	Stockage .....	86
10	Mise en service .....	86
11	Interface (uniquement pour les centrifugeuses avec interface) .....	87
12	Ouvrir et fermer le couvercle .....	87
12.1	Ouvrir le couvercle .....	87
12.2	Fermer le couvercle .....	87
13	Montage et démontage du rotor .....	87
14	Insérer et retirer les suspensions dans le rotor .....	88
15	Insérer et retirer les adaptateurs dans les suspensions .....	88
16	Chargement du rotor .....	89
17	Fermeture des systèmes de sécurité biologique .....	90
18	Instructions d'emballage HettLiner .....	91
18.1	Emballer avant la centrifugation .....	91
18.2	Déballer après la centrifugation .....	92
19	Éléments de commande et d'affichage .....	93
19.1	Symboles d'état .....	93
19.2	Bouton de réglage .....	93
19.3	Touches et possibilités de réglage .....	93
20	Saisie des paramètres de centrifugation .....	94
20.1	Durée de fonctionnement .....	94
20.1.1	Présélection de la durée .....	94
20.1.2	Fonctionnement en continu .....	94
20.2	Vitesse de rotation (RPM) .....	94
20.3	Accélération relative de centrifugation (RCF/RZB) .....	94
20.4	Paramètres de démarrage et paramètres de rotation par inertie .....	94
20.4.1	Niveau de démarrage .....	95
20.4.2	Temps de démarrage .....	95
20.4.3	Niveau de freinage .....	95
20.4.4	Temps de rotation par inertie .....	95
20.4.5	Nombre de tours de l'arrêt de freinage .....	95
20.5	Rayon/température .....	95
20.5.1	Rayon .....	95
20.5.2	Température .....	95
20.6	Mémoire tampon automatique .....	95

21	Programmation.....	96
21.1	Introduction de programme / modification de programme.....	96
21.2	Récupération de programme .....	96
22	Centrifugation.....	96
22.1	Centrifugation avec présélection de la durée .....	96
22.2	Fonctionnement en continu.....	96
23	Modifier des réglages pendant le processus de centrifugation.....	97
24	Integral RCF (ÍRCF) .....	97
25	Affichage de la vitesse de rotation maximale du rotor .....	97
26	Affichage de la valeur RCF maximale du rotor .....	97
27	Arrêt d'urgence .....	97
28	Signal acoustique .....	97
29	Interrogation relative au nombre d'heures de service.....	98
30	Réglage de la date et de l'heure.....	98
31	Données de centrifugation, affichées suite à la mise en service .....	98
32	Affichage immédiat des données de centrifugation suite à la mise en service .....	98
33	Interrupteur à clé .....	98
34	Création de liens entre programmes (uniquement dans le cas de centrifugeuses dotées de la fonction de création de liens entre programmes).....	98
34.1	Créer des liens entre programmes.....	99
34.2	Modifier les liens entre programmes .....	99
34.3	Processus de centrifugation avec lien entre programmes.....	99
34.4	Effacer des liens entre programmes .....	99
35	Refroidissement .....	100
35.1	Refroidissement en veilleuse .....	100
35.2	Pré-refroidissement du rotor .....	100
36	Chauffage.....	100
37	Accélération centrifuge relative (RCF).....	100
38	Centrifugation de matières et de mélanges d'une densité supérieure à 1,2 kg/dm <sup>3</sup> .....	101
39	Identification du rotor.....	101
40	Déverrouillage d'urgence.....	101
41	Entretien et maintenance .....	102
41.1	Centrifugeuse (boîtier, couvercle et cuve).....	102
41.1.1	Entretien et nettoyage des surfaces.....	102
41.1.2	Désinfection des surfaces .....	102
41.1.3	Décontamination de substances radioactives .....	102
41.2	Rotors et accessoires.....	103
41.2.1	Nettoyage et entretien.....	103
41.2.2	Désinfection .....	103
41.2.3	Décontamination de substances radioactives .....	104
41.2.4	Goupilles de fixation.....	104
41.2.5	Rotors et accessoires à durée d'utilisation limitée .....	104
41.2.6	Calcul du nombre de cycles exécutés.....	104
41.3	Autoclave .....	105
41.4	Réservoirs de centrifugation .....	105

---

42	Défauts .....	106
43	Renvoi d'appareils au fabricant .....	107
44	Mise au rebut .....	107
45	Anhang / Appendix .....	140
45.1	Rotoren und Zubehör / Rotors and accessories .....	140

## 1 Utilisation de ce mode d'emploi

- Lisez et respectez impérativement les consignes et indications contenues dans le mode d'emploi avant d'utiliser la centrifugeuse.
- Le mode d'emploi fait partie intégrante de l'appareil. Vous devez le conserver de manière à toujours être à portée de main.
- Si vous changez l'appareil de place, le mode d'emploi doit suivre l'appareil.

## 2 Signification des symboles



Symbole sur l'appareil :  
Attention, zone de danger général.



Symbole sur l'appareil :  
respecter le mode d'emploi.  
Ce symbole indique que l'utilisateur doit respecter le mode d'emploi mis à disposition.



Symbole dans ce document:  
Attention, zone de danger général.  
Ce symbole indique des consignes de sécurité et signale des situations pouvant être sources de danger.  
Le non-respect de ces instructions peut entraîner des dégâts matériels et personnels.



Symbole sur l'appareil et dans ce document:  
Avertissement de menace biologique pour l'environnement.



Symbole sur l'appareil et dans ce document:  
Faire attention aux surfaces chaudes.  
La non observance de ces indications peut conduire à des dommages matériels et corporels.



Symbole sur l'appareil:  
Équipotentiel : connecteur à fiche (connecteur L.E.P.) pour la liaison équipotentielle (uniquement pour une centrifugeuse avec un connecteur L.E.P.).



Symbole sur l'appareil:  
Positions de commutation de l'interrupteur à clé.



Symbole sur l'appareil:  
Interface optique (uniquement pour les centrifugeuses avec interface optique).



Symbole dans ce document:  
Ce symbole signale des informations importantes.



Symbole sur l'appareil et dans ce document:  
Symbole pour la collecte séparée des appareils électriques et électroniques, conformément à la directive 2012/19/EU.

Utilisation dans les pays de l'Union Européenne ainsi qu'en Norvège et en Suisse.



Symbole sur l'emballage :  
Stocker, transporter et manipuler l'emballage pour le transport à l'intérieur de la plage d'humidité affichée (10% - 80%).

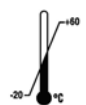

Symbole sur l'emballage :  
Stocker, transporter et manipuler l'emballage d'expédition à l'intérieur de la plage de température affichée (-20°C - +60°C).



Symbole sur l'emballage :  
Tenir l'emballage pour le transport éloigné de la pluie et le stocker dans un endroit sec.



Symbole sur l'emballage :  
Ce côté vers le haut.



Symbole sur l'emballage :  
Fragile, manipuler avec précaution.



Symbole sur l'emballage:  
Limite d'empilage. Nombre maximum de packs identiques pouvant être empilés sur le pack le plus bas, sachant que „n” correspond au nombre de packs autorisés. Le pack le plus bas n'est pas compris dans „n”.

### 3 Utilisation conforme

Le présent appareil est une centrifugeuse de laboratoire adaptée aux applications médicales.

Son utilisation thérapeutique est exclusivement la centrifugation de sang dans des systèmes de poches de sang. Les composants sanguins séparés sont transférés par un autre appareil (séparateur) dans des poches satellites correspondantes. Les composants individuels ainsi obtenus sont ensuite utilisés pour la transfusion ou l'autotransfusion.

La centrifugeuse ne doit être utilisée que par du personnel spécialisé dans les services de transfusion sanguine ou les hôpitaux.

La centrifugeuse est destinée uniquement aux fonctions citées ci-dessus.

Toute utilisation différente ou dépassant ce cadre est considérée comme non conforme. La société Andreas Hettich GmbH & Co. n'est pas responsable des dommages qui en résultent.

L'utilisation conforme aux dispositions comprend le respect de toutes les indications énoncées dans le mode d'emploi et le respect des intervalles d'inspection et de maintenance.

### 4 Risques résiduels

L'appareil est construit conformément au niveau actuel de la technologie et des règles de sécurité éprouvées.

L'utilisation et la manipulation non conforme de cet appareil risquent de menacer la santé et l'intégrité corporelle de l'utilisateur ou de tierces personnes, ou de détériorer l'appareil ou autres biens matériels.

Utilisez exclusivement l'appareil conformément à l'usage pour lequel il a été conçu et uniquement s'il est dans un état de fonctionnement technique irréprochable.

Remédier sans attendre à tout dérangement susceptible de porter atteinte à la sécurité.



## 5 Données techniques

Fabricant	Andreas Hettich GmbH & Co. KG D-78532 Tuttlingen			
Modèle	ROTIKA 500 RS			
Basic UDI-DI	4050674010002Q2			
Type	4950, 4950-50		4950-70, 4950-80	
Tension du réseau ( $\pm 10\%$ )	230-240 V ~	220 V ~	230-240 V ~	220 V ~
Fréquence du réseau	50 Hz	60 Hz	50 Hz	60 Hz
Charge de connexion	3800 VA			
Consommation de courant	16 A			
Réfrigérant	R452A			
Capacité max.	4 x 1000 ml			
Densité admise	1.2 kg/dm <sup>3</sup>			
Vitesse de rotation (RPM)	11500			
Accélération (RCF)	18038			
Energie cinétique	59620 Nm			
Obligation de contrôle (DGUV Regel 100 – 500)	oui			
Conditions ambiantes (EN / IEC 61010-1)	<p>uniquement dans les intérieurs</p> <p>Jusqu'à 2000 m au dessus du niveau de la mer</p> <p>5°C à 35°C</p> <p>humidité de l'air max. relative 80% pour températures jusqu'à 31°C, décroissant en linéaire jusqu'à 50% de l'humidité relative pour 40°C.</p>			
– Emplacement				
– Hauteur				
– Température ambiante				
– Humidité de l'air				
– Catégorie de surtension (IEC 60364-4-443)	II			
– Degré d'encrassement	2			
Catégorie de protection de l'appareil	I			
Non approprié pour l'usage dans un environnement exposé aux explosions.				
EMV	EN / IEC 61326-1, catégorie B			
– Emission de parasites, Résistance aux interférences				
Niveau du bruit (en fonction du rotor)	$\leq 65$ dB(A)		$\leq 63$ dB(A)	
Dimensions				
– Largeur	650 mm			
– Profondeur	814 mm			
– Hauteur	973 mm			
Poids	env. 219 kg		env. 233 kg	

Fabricant	Andreas Hettich GmbH & Co. KG D-78532 Tuttlingen	
Modèle	ROTIXA 500 RS	
Basic UDI-DI	4050674010002Q2	
Type	4950-08, 4950-58	4950-78, 4950-88
Tension du réseau ( $\pm 10\%$ )	208 V ~	
Fréquence du réseau	60 Hz	
Charge de connexion	3800 VA	
Consommation de courant	18 A	
Réfrigérant	R452A	
Capacité max.	4 x 1000 ml	
Densité admise	1.2 kg/dm <sup>3</sup>	
Vitesse de rotation (RPM)	11500	
Accélération (RCF)	18038	
Energie cinétique	59620 Nm	
Obligation de contrôle (DGUV Regel 100 – 500)	oui	
Conditions ambiantes (EN / IEC 61010-1)	<p>uniquement dans les intérieurs Jusqu'à 2000 m au dessus du niveau de la mer 5°C à 35°C humidité de l'air max. relative 80% pour températures jusqu'à 31°C, décroissant en linéaire jusqu'à 50% de l'humidité relative pour 40°C.</p>	
– Emplacement	II	
– Hauteur	2	
– Température ambiante	I	
– Humidité de l'air		
– Catégorie de surtension (IEC 60364-4-443)		
– Degré d'encrassement		
Catégorie de protection de l'appareil	I	
Non approprié pour l'usage dans un environnement exposé aux explosions.		
EMV	FCC Class B	
– Emission de parasites, Résistance aux interférences		
Niveau du bruit (en fonction du rotor)	$\leq 65$ dB(A)	$\leq 63$ dB(A)
Dimensions		
– Largeur	650 mm	
– Profondeur	814 mm	
– Hauteur	973 mm	
Poids	env. 225 kg	env. 239 kg

## 6 Consignes de sécurité



**Aucune demande garantie ne pourra être revendiquée auprès du fabricant si les indications données dans ce mode d'emploi ne sont pas toutes respectées.**



### **Notifications d'incidents graves avec l'appareil**

En cas d'incident grave avec l'appareil, le signaler au fabricant et, le cas échéant, aux autorités compétentes.



- **Veiller à la stabilité de la centrifugeuse.**
- **Avant d'utiliser la centrifugeuse, il est indispensable de vérifier la fixation correcte du rotor.**
- **Durant un processus de centrifugation, aucune personne, matière dangereuse et aucun objet ne doivent se trouver dans une zone de sécurité de 300 mm autour de la centrifugeuse selon EN / IEC 61010-2-020.**
- **Les rotors, balanciers et accessoires qui présentent d'importantes traces de corrosion ou des défauts mécaniques ou dont la durée d'utilisation a expiré ne doivent plus être utilisés.**
- **Suspendre immédiatement l'utilisation de la centrifugeuse si la cuve de centrifugeuse présente des dommages susceptibles de porter atteinte à la sécurité.**
- **Les goupilles de fixation des rotors à amortissement doivent être graissées régulièrement (graisse de lubrification Hettich n° 4051) de manière à assurer le balancement régulier de la suspension.**
- **Concernant les centrifugeuses sans réglage de température, il peut y avoir un réchauffement dans la cuve de centrifugeuse en cas de température ambiante élevée et/ou d'utilisation fréquente de l'appareil. Il n'est donc pas possible d'exclure une modification de l'échantillon due à la température.**

- **Il importe de lire et de respecter le mode d'emploi avant la mise en service de la centrifugeuse. Seules les personnes ayant lu et compris le mode d'emploi sont autorisées à manipuler l'appareil.**
- Outre le mode d'emploi et les réglementations contraignantes relatives à la prévention des accidents, il importe également de respecter les règles spécifiques et communément admises en matière de sécurité et de travail. Le mode d'emploi doit être complété des dispositions nationales applicables à la prévention des accidents et à la protection de l'environnement.
- La centrifugeuse a été construite conformément à l'état actuel de la technique et son fonctionnement est sûr. Elle peut cependant présenter des dangers pour l'utilisateur ou des tiers si son utilisation n'est pas confiée à un personnel dûment formé, est inadéquate ou non conforme à sa destination.
- Pendant le fonctionnement, la centrifugeuse ne devra pas être déplacée ou être heurtée.
- En cas de défaillance ou en cas de déverrouillage d'urgence, ne jamais intervenir dans l'appareil lorsque le rotor tourne.
- Afin d'éviter les dommages causés par la condensation en passant d'un local froid à un local chaud, il faut soit réchauffer la centrifugeuse en la laissant pendant au moins 3 heures dans le local chaud avant de la raccorder au secteur, soit la faire fonctionner pendant 30 minutes dans le local froid pour la chauffer.
- Pour cet appareil, vous ne devez utiliser que des rotors et des accessoires homologués par le fabricant (voir chapitre "Anhang/Appendix, Rotoren und Zubehör/Rotors and accessories"). Avant d'utiliser des récipients de centrifugation qui ne sont pas présentés dans le chapitre "Annexe/Appendix, rotors et accessoire/Rotors and accessories", l'utilisateur doit s'assurer auprès du fabricant qu'il peut les utiliser.
- Le rotor de la centrifugeuse doit uniquement être chargé conformément au chapitre "Chargement du rotor".
- Dans le cas de la centrifugation à la vitesse maximale, la densité des substances et des mélanges de substances ne doit pas excéder 1,2 kg/dm<sup>3</sup>.
- Il est interdit de procéder à des centrifugations en présence de défauts d'équilibrage.
- La centrifugeuse ne doit pas être exploitée dans un environnement explosif.

- Il est interdit de procéder à des centrifugations :
  - avec des matières inflammables ou explosives,
  - avec des matières susceptibles de réagir chimiquement ou de dégager d'importantes quantités d'énergie.En cas de centrifugation d'échantillons pétrochimiques conformément aux directives de la norme ASTM, l'utilisateur est tenu de procéder à une évaluation du risque.
  
- L'utilisateur est tenu de prendre des mesures appropriées lors de la centrifugation de substances, ou mélanges de substances, dangereuses qui sont contaminées de manière toxique, radioactive ou par des microorganismes pathogènes.

De manière générale, utiliser des réservoirs de centrifugation avec fermeture à vis spéciales pour substances dangereuses. Concernant les matériaux du groupe à risque 3 et 4, utilisez, en plus des réservoirs de centrifugation verrouillables, un système de biosécurité (voir manuel "Laboratory Bio-safety Manual" de l'Organisation Mondiale de la Santé).

Dans un système de biosécurité, une bio-étanchéité (bague d'étanchéité) empêche les fuites de gouttes et d'aérosols.

Si vous employez le balancier d'un système de biosécurité sans le couvercle, il faut retirer la bague d'étanchéité du balancier afin d'éviter que la bague d'étanchéité soit endommagée pendant le cycle de centrifugation.

Tout système de biosécurité défectueux n'est plus étanche du point de vue microbiologique.

Une centrifugeuse utilisée sans système de biosécurité n'est plus étanche du point de vue microbiologique dans l'esprit de la norme NE / IEC 61010-2-020.

Veuillez suivre les instructions au chapitre "Fermeture des systèmes de sécurité biologique" lorsque vous fermez un système de biosécurité.

Vous trouverez au chapitre "Annexe/Appendix, rotors et accessoires/Rotors and accessories" la liste des systèmes de biosécurité pouvant être livrés. En cas de doute, veuillez vous renseigner auprès du fabricant.
  
- Il est interdit de centrifuger des matières fortement corrosives pouvant réduire la résistance mécanique des rotors, des supports et des accessoires.
  
- Les réparations ne peuvent être effectuées que par une personne autorisée à cet effet par le fabricant.
  
- Utiliser uniquement les pièces de rechange originales et les accessoires d'origine homologués par les Etablissements Andreas Hettich GmbH & Co. KG.
  
- Les dispositions de sécurité suivantes font foi :  
EN / IEC 61010-1 et EN / IEC 61010-2-020 ainsi que les dérogations nationales.
  
- La sécurité et la fiabilité de la centrifugeuse seront uniquement garanties si :
  - la centrifugeuse est utilisée conformément aux instructions du mode d'emploi,
  - l'installation électrique du site de la centrifugeuse est conforme aux prescriptions EN / IEC.
  
- Le fait de respecter les prescriptions nationales relatives à la sécurité au travail concernant l'utilisation de centrifugeuses de laboratoire sur le lieu de travail prévu à cet effet par l'exploitant relève de la responsabilité du dit exploitant.

## 7 Déballage et installation de la centrifugeuse

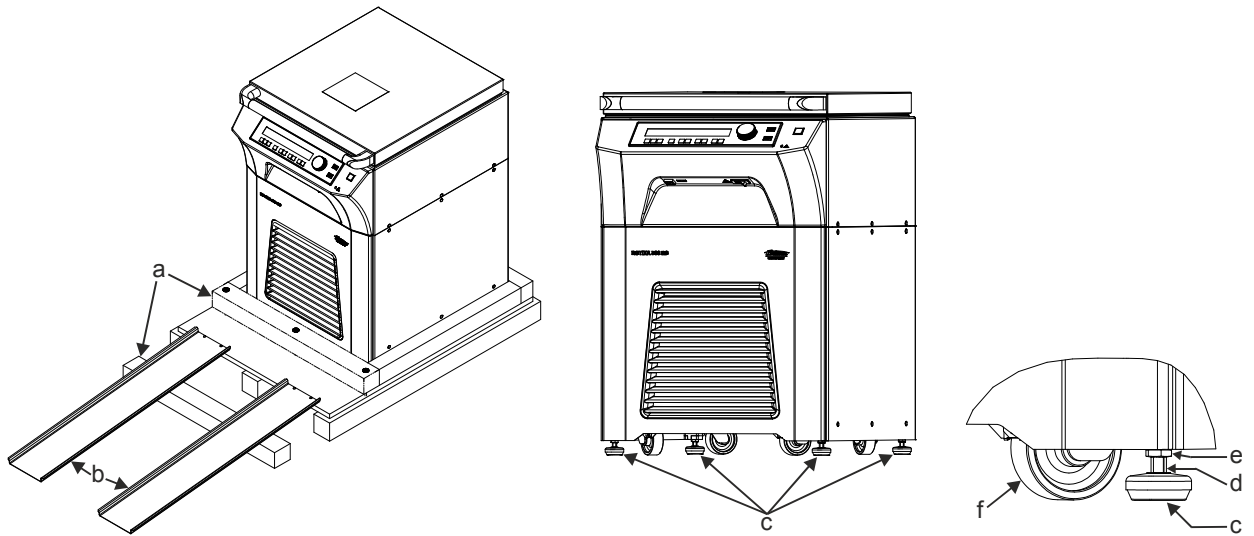

- Enlever l'emballage.
- Enlever la poutre avant (a).
- Fixer les rails métalliques (b) sur la palette en bois à l'aide de deux clous par rail.
- Faire glisser la poutre avant (a) sous les rails métalliques (b) pour les soutenir.
- Poser la clé plate fournie (taille 10 mm) sur les surfaces (d) et tourner les pieds de l'appareil (c) à fond vers le haut.
- Faire rouler avec précaution la centrifugeuse sur les rails métalliques (b) pour la descendre de la palette en bois.
- Pousser la centrifugeuse sur son site d'implantation.
- Placer la clé à fourche fournie (taille 10 mm) sur les surfaces (d) et tourner les pieds de l'appareil (c) vers le bas jusqu'à ce que les roulettes orientables (f) ne soient plus en contact avec le sol.
- Tourner les pieds de l'appareil (c) pour aligner la centrifugeuse à l'horizontale.
- Tourner les écrous 6 pans (e) vers le haut avec la clé à fourche fournie (taille 19 mm) et serrer pour bloquer la position des pieds de l'appareil (c).

## 8 Composition de la livraison

- 1 Cordon de raccordement au secteur
- 1 Clé plate simple, taille 10 mm (pour tourner les pieds de l'appareil)
- 1 Clé plate double, taille 17/19 mm (pour serrer les écrous 6 pans sur les pieds de l'appareil)
- 1 Clé carrée (pour monter et démonter le rotor)
- 1 Clé allen six pans (pour le déverrouillage de secours du couvercle)
- 1 Graisse pour tourillon porteur
- 1 Videur de tube
- 10 Capuchons (∅12 mm) pour têtes de vis à empreinte Torx T20
- 1 Mode d'emploi
- 3 Fiche de données du programme

Le(s) rotor(s) et accessoires correspondant sont livrés selon les spécifications de la commande.

## 9 Transport et stockage

### 9.1 Transport

Respecter les conditions ambiantes suivantes pour transporter l'appareil et ses accessoires :

- Température ambiante : -20°C à +60°C
- Humidité relative de l'air : 10% à 80%, non condensante

### 9.2 Stockage



Ne stocker l'appareil et ses accessoires que dans une pièce fermée au sec.

Respecter les conditions ambiantes suivantes pour stocker l'appareil et ses accessoires :

- Température ambiante : -20°C à +60°C
- Humidité relative de l'air : 10% à 80%, non condensante

## 10 Mise en service

- Si l'appareil est protégé en plus par un disjoncteur différentiel dans l'installation du bâtiment, il faut utiliser un disjoncteur différentiel de type B. En cas d'utilisation d'un autre type, il peut arriver que le disjoncteur différentiel ne coupe pas l'appareil en présence d'un défaut sur l'appareil ou qu'il coupe l'appareil alors qu'il n'y a pas de défaut sur l'appareil.
- Les modèles 4950-08, 4950-58, 4950-78 et 4950-88 sont des appareils à branchement fixe. Pour les appareils raccordés de manière fixe, un interrupteur doit être placé dans l'installation du bâtiment pour couper l'alimentation secteur de l'appareil, conformément à la norme sur les appareils de laboratoire EN / CEI 61010-1. L'interrupteur doit se trouver à proximité de l'appareil, être facilement accessible pour l'utilisateur et être identifié comme un dispositif de déconnexion pour cet appareil. L'interrupteur doit pouvoir être protégé contre une remise en marche.
- Les modèles 4950-70, 4950-78, 4950-80 et 4950-88 doivent uniquement être installés par du personnel autorisé et qualifié.



Ces appareils doivent être installés conformément aux consignes de mise en place et d'installation AH4950FR ci-jointes.

- **Placer la centrifugeuse sur un emplacement approprié de manière à ce qu'elle soit stable et mettre de niveau. Lors de la mise en place, il faut respecter la zone de sécurité exigée de 300mm autour de la centrifugeuse selon EN / IEC 61010-2-020.**



**Durant un processus de centrifugation, aucune personne, matière dangereuse et aucun objet ne doivent se trouver dans une zone de sécurité de 300 mm autour de la centrifugeuse selon EN / IEC 61010-2-020.**

- Ne pas recouvrir les fentes d'aération.  
Veuillez respecter un écart de 300 mm jusqu'aux fentes et ouvertures d'aération de la centrifugeuse.
- Centrifugeuse avec un connecteur L.E.P. :  
relier en cas de besoin le connecteur L.E.P. au dos de l'appareil à un système médical de liaison équipotentielle supplémentaire.
- Centrifugeuse avec interface optique :  
Branchez l'interface optique de la centrifugeuse sur le PC avec un câble à fibre optique (non comprise dans la livraison).
- Vérifier que la tension de secteur est identique à la mention de la plaque signalétique.
- Brancher la centrifugeuse avec son cordon de raccordement sur une prise secteur aux normes. Puissance connectée voir chapitre "Données techniques".
- Activer l'interrupteur de secteur. Amener l'interrupteur en position "I".  
Messages sur l'afficheur :  
1. Modèle de centrifugeuse, 2. Le dernier code de rotor identifié par la fonction d'identification de rotor et la vitesse de rotation maximale du rotor (n-max-Rotor), 3. Version de programme, 4. **OPEN** / **OEFFNEN**.
- Ouvrir le capot.  
Les données de centrifuge du dernier programme utilisé ou du programme 1 s'affichent.

## 11 Interface (uniquement pour les centrifugeuses avec interface)

En option, l'appareil peut être équipé d'une interface optique.





L'interface optique est désignée par le symbole 

Via cette interface, vous pouvez commander la centrifugeuse et chercher des données.

## 12 Ouvrir et fermer le couvercle



### 12.1 Ouvrir le couvercle

 Le capot ne peut être ouvert que lorsque la centrifugeuse est sous tension et que le rotor est à l'arrêt. Dans les autres cas, voir le chapitre, "Déverrouillage d'urgence".

- Appuyer sur la touche  sur le panneau frontal. Le couvercle est déverrouillé par le moteur, l'éclairage de la touche  s'éteint et le symbole de l'affichage  devient le symbole .

### 12.2 Fermer le couvercle

 Ne pas mettre les doigts entre le couvercle et le boîtier.  
Ne pas laisser tomber le couvercle pour le fermer.

- Poser le couvercle dessus et le pousser légèrement vers le bas par la poignée en tube. Le verrouillage est automatique. La touche  s'allume et sur l'afficheur, l'icône  bascule sur l'icône .

## 13 Montage et démontage du rotor

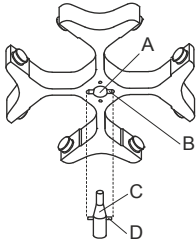

- Nettoyer l'arbre d'entraînement (C) et l'alésage du rotor (A) et enduire ensuite l'arbre d'entraînement d'une pellicule de graisse. Les particules d'impuretés entre l'arbre d'entraînement et le rotor réduisent la stabilité d'assise du rotor et provoquent un fonctionnement irrégulier.
- Enficher le rotor à la verticale sur l'arbre d'entraînement. Le taquet de l'arbre d'entraînement (D) doit être logé dans la rainure du rotor (B). L'orientation de la rainure est indiquée sur le rotor.
- Serrer l'écrou de fixation du rotor avec la clé de la livraison en tournant dans le sens horloger.
- Vérifier la stabilité d'assise du rotor.



Bien serrer à la main l'écrou du rotor afin de garantir une bonne fixation du rotor.

- Démontage du rotor: Desserrer l'écrou de fixation par rotation dans le sens anti-horloger jusqu'à ce que le rotor puisse être détaché par pression. En exerçant une légère pression, détacher le rotor du cône de l'arbre d'entraînement. Dévisser l'écrou de fixation jusqu'à ce que le rotor soit détaché de l'arbre d'entraînement.

## 14 Insérer et retirer les suspensions dans le rotor

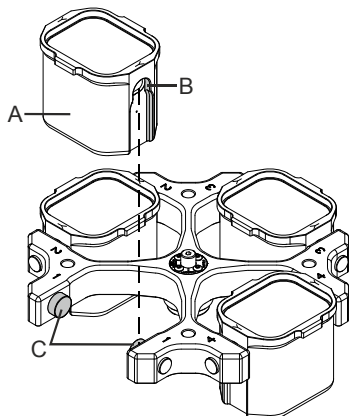

En cas de rotors à oscillation, chaque emplacement du rotor doit être occupé avec les **mêmes** suspensions.



Certaines suspensions sont identifiées par le numéro de l'emplacement du rotor. Ces suspensions ne peuvent être utilisées qu'à l'emplacement correspondant du rotor.

Les suspensions pourvues d'un numéro de jeu, S001/4 par ex., ne peuvent être utilisées qu'avec le jeu.

### Insérer les suspensions dans le rotor :

- Vérifier si le rotor se trouve dans une position fixe.
- Graisser les tourillons (C) (graisse Hettich n° 4051).
- Insérer les suspensions (A) dans le rotor. Pour ce faire, veiller à ce que les tourillons (C) se trouvent dans les rainures (B) des suspensions.
- Enfoncer les suspensions jusqu'à la butée.

### Retirer les suspensions du rotor :

- Retirer les suspensions (A) du rotor à la verticale.

## 15 Insérer et retirer les adaptateurs dans les suspensions

### Insérer les adaptateurs dans les suspensions :

- Insérer les adaptateurs (A) à l'horizontale dans les suspensions (B).

### Retirer les adaptateurs des suspensions :

- Retirer les adaptateurs (A) des suspensions (B) en les tirant vers le haut.

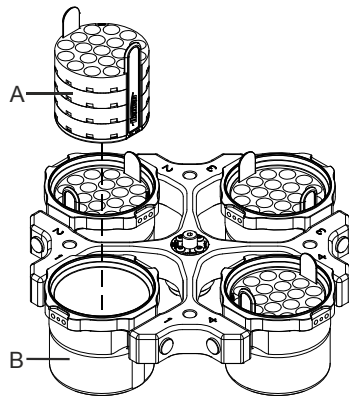
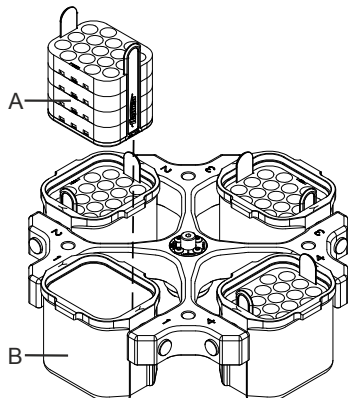



## 16 Chargement du rotor



Des récipients standard de centrifugation en verre sont résistants jusqu' à un ACR de 4000 (DIN 58970, partie 2).

- Vérifier la stabilité d'assise du rotor.
- Dans le cas des rotors à balanciers, toutes les positions des rotors doivent être équipées avec les **mêmes** balanciers. Certains balanciers sont désignés avec le numéro de la place du rotor. Ces balanciers doivent exclusivement être installés dans la place de rotor correspondante. Les balanciers désignés par un numéro de set, comme S001/4 par exemple, doivent exclusivement être utilisés dans le set.
- Le chargement des rotors et des balanciers doit être nécessairement symétrique. Les conteneurs de centrifugation doivent être uniformément répartis sur toutes les positions du rotor. Pour les combinaisons possibles, voir le Chapitre "Anhang/Appendix, Rotoren und Zubehör/Rotors and accessories". Dans le cas des rotors à angle fixe, il faut charger tous les logements possibles du rotor, voir au chapitre "Annexe/Appendix, Rotors et accessoires/Rotors and accessories".

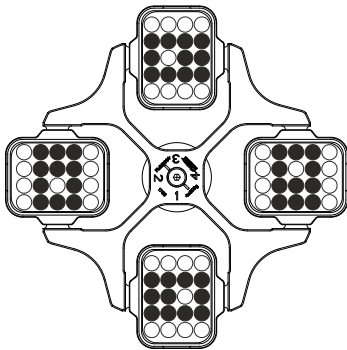

Le rotor est chargé de manière symétrique

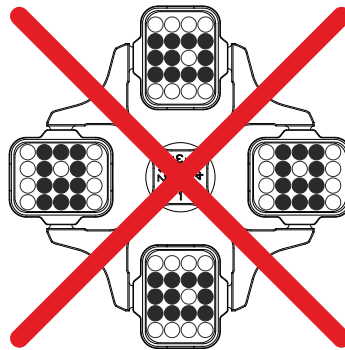

**Non autorisé !**  
Le rotor n'est pas chargé de manière symétrique

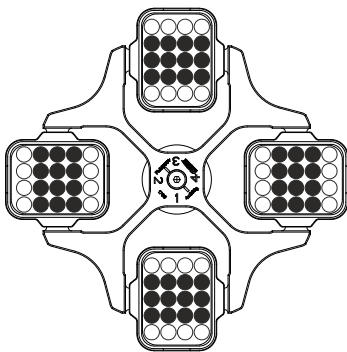

Rotor uniformément chargé

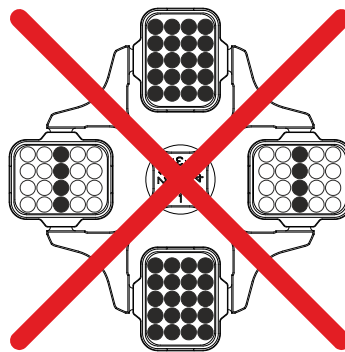

**Non autorisé !**  
Rotor irrégulièrement chargé

- Certains dispositifs de suspension indiquent soit le poids maximum de la charge, soit le poids total maximum comprenant charge et dispositifs. Pour les cas d'exception, voir le chapitre "Centrifugation de matières et de mélanges d'une densité supérieure à 1,2 kg/dm<sup>3</sup>". L'indication du poids de la charge maximale comprend le poids total de l'adaptateur, du réservoir de centrifugation et du contenu.
- Dans le cas des récipients à garniture de caoutchouc, les récipients de centrifugation doivent avoir le même nombre de garnitures dans la partie inférieure.
- Remplissez les réservoirs de centrifugation uniquement en dehors de la centrifugeuse.

- La quantité maximale de remplissage indiquée par le fabricant pour les récipients de centrifugation ne doit pas être dépassée.

Pour les rotors angulaires, remplir les réservoirs de centrifugation de sorte que du liquide ne puisse pas être projeté à l'extérieur pendant le cycle de centrifugation

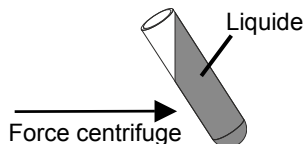

- Aucun fluide ne doit pénétrer dans les rotors angulaires et dans la cuve de centrifugeuse lors du chargement des rotors angulaires.
- Pendant le chargement de la suspension des balanciers, et pendant le balancement de la suspension dans le cycle de centrifugation, aucun fluide ne doit pénétrer dans la cuve de centrifugeuse.
- La hauteur de remplissage des récipients sera autant que possible égale pour maintenir les différences de poids entre les récipients de centrifugation aussi réduites que possible.

## 17 Fermeture des systèmes de sécurité biologique



Pour garantir l'étanchéité, le couvercle d'un système de sécurité biologique doit être solidement fermé.

Pour éviter de fausser la bague d'étanchéité en ouvrant et en fermant le couvercle, il faut frotter légèrement la bague d'étanchéité avec un produit d'entretien pour caoutchouc.

Pour ce qui concerne les systèmes à sécurité biologique, voir le chapitre "Anhang/Appendix, Rotoren und Zubehör/Rotors and accessories". Dans le doute vous pouvez obtenir les informations auprès du fabricant.

### Couvercle à fermeture vissée et alésage dans la poignée tournante

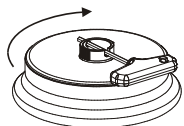

- Poser le couvercle sur le rotor, au centre.
- Insérer la clé fournie avec l'équipement dans l'alésage de la poignée tournante et fermer solidement le couvercle en le vissant dans le sens des aiguilles d'une montre.

### Couvercle avec fermeture à vis

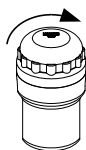

- Placer le couvercle sur le balancier.
- Bien fermer le couvercle en le tournant à la main dans le sens des aiguilles d'une montre.

## 18 Instructions d'emballage HettLiner

### 18.1 Emballer avant la centrifugation

Avis: veiller à ce que l'élément en plastique ne puisse pas basculer lors du chargement et du déchargement des inserts (utiliser le dispositif d'aide au chargement 4509).

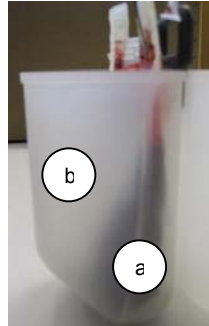
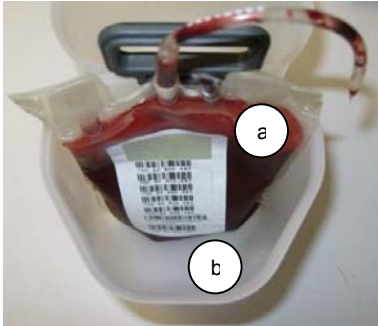

- Placer dans l'insert (b) la poche de sang (a).

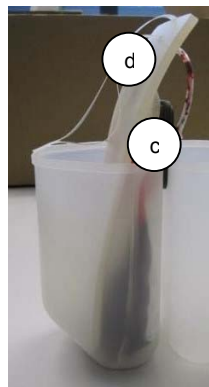
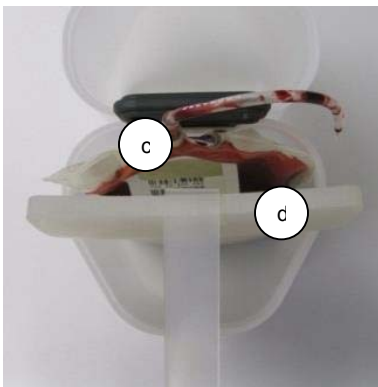

- Fixer la poche de sang aux raccords (c) et pousser dans l'insert la plaque de support (d) située sur le côté extérieur de la poche en la déplaçant de haut en bas.
- Ce faisant, veiller à ce que le bord inférieur de la plaque de support repose le plus possible complètement au sol.

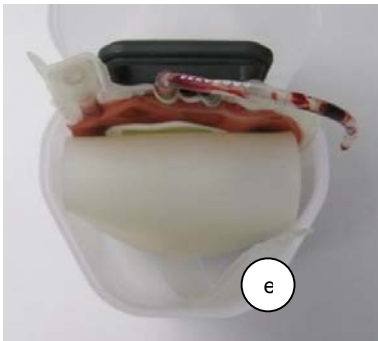

- Rabattre vers l'extérieur la plaque de support et la pousser le plus possible vers le bas, jusqu'à ce que le bord rabattu de la plaque se trouve au niveau du liquide de la poche de sang.
- Ce faisant, veiller à la position de la boucle (e) afin de pouvoir atteindre celle-ci après la centrifugation!
- Le bord supérieur de la plaque de support ne doit pas trop dépasser de l'insert lors de la centrifugation à cause du risque de coincement avec les bras du rotor!

- S'il y en a, plier la/les poche.s satellite.s vide.s et les emballer selon les accessoires correspondants et le volume des poches de sang.  
Il est préférable de plier les poches satellites et de les emballer à l'extérieur entre la plaque de support rabattue et la paroi extérieure de l'insert.  
→ Veiller à ce que la plaque en silicone ne glisse pas!  
→ Le cas échéant, tenir la boucle de la plaque en silicone lors de l'emballage de la poche satellite afin de la bloquer.  
→ Vérifier ensuite la position de la boucle!
- Placer les raccords au-dessus de la plaque de support de sorte que les vannes ne puissent pas se casser.  
Veiller à ce que les tuyaux ne dépassent pas de l'insert!  
→ Ranger entre la plaque de support rabattue et la paroi de l'insert les parties de tuyaux qui dépassent du bord de l'insert.

- Si besoin est, placer entre la plaque de support rabattue et la paroi du bécher les contrepoids.

## 18.2 Déballer après la centrifugation

- Retirer la poche satellite de l'insert tout en fixant d'une main la plaque en silicone.
- Retirer lentement la partie rabattue de la plaque de support en la tenant par la boucle prévue à cet effet!  
→ Attention : remettre la plaque de support dans sa forme initiale en faisant bien attention!  
→ La partie rabattue de la plaque peut "rebondir" et mélanger des composants sanguins.
- La poche de sang restante peut être retirée soit avec la plaque de support, soit une fois la plaque de support retirée de l'insert!

## 19 Éléments de commande et d'affichage

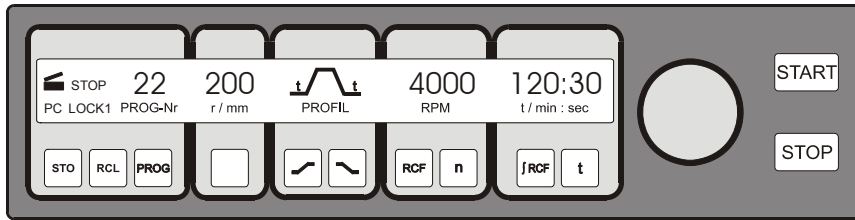

### 19.1 Symboles d'état



Couvercle ouvert.



Couvercle fermé.



Affichage de la rotation. L'affichage apparaît durant le processus de centrifugation, tant que le rotor tourne.



Processus de centrifugation arrêté ou terminé. L'affichage apparaît une fois le processus de centrifugation clôturé, tant que le rotor tourne. Suite à un arrêt d'urgence, l'affichage clignote.

**LOCK 1,  
LOCK 2**

Position enclenchée de l'interrupteur à clé.

**LOCK 4,  
LOCK 5**

Verrouillage du programme en cas de communication série (uniquement dans le cas de centrifugeuses avec communication série).

**PC, PE**

Communication série (uniquement dans le cas de centrifugeuses avec communication série).

Les erreurs de commande ou les incidents sont symbolisés à l'écran (se reporter au chapitre "Défauts").

### 19.2 Bouton de réglage



Pour le réglage des paramètres individuels.

Pour faire décroître la valeur, tourner le bouton dans le sens anti-horaire. Pour augmenter la valeur, tourner le bouton dans le sens horaire.

### 19.3 Touches et possibilités de réglage



Durée de fonctionnement, paramètres t/min:sec

1. Paramètres t/min: réglables de 1 à 999 min, par intervalles d'1 minute.
2. Paramètres t/:sec réglables de 1 à 59 s, par intervalles d'1 seconde.
3. Fonctionnement en continu"---:--"



Interrogation de l'Integral RCF, paramètre ∫RCF.



1. Vitesse de rotation, paramètre RPM

- Il est possible de régler une valeur numérique comprise entre 50 RPM et la vitesse de rotation maximale du rotor (n-max-Rotor). Pour la vitesse maximale de rotation du rotor, se reporter au chapitre "Anhang/Appendix, Rotoren und Zubehör/Rotors and accessories". Réglable par intervalles de 10.
2. Interrogation de la vitesse maximale de rotation du rotor, paramètres n-max-Rotor.



1. Accélération de centrifugation relative, paramètres RCF/RZB

- Il est possible de régler une valeur numérique dont découle une vitesse de rotation située entre 50 RPM et la vitesse maximale de rotation du rotor (n-max-Rotor). Réglable par intervalles de 1.
2. Interrogation du RCF maximal du rotor, paramètres RCF-max-Rotor.



Paramètres de démarrage

1. Niveaux de démarrage, paramètres  $\curvearrowright$ <sub>1-9</sub>. Niveau 9 = temps de démarrage le plus court, ... Niveau 1 = temps de démarrage le plus long.
2. Temps de démarrage, paramètres  $\curvearrowright$ <sub>min:sec</sub>. L'intervalle de temps pouvant être réglé dépend de la vitesse de rotation paramétrée.



Paramètres de rotation par inertie

1. Niveaux de freinage, paramètres  $\curvearrowleft$ <sub>0-9</sub>. R = courbe de freinage linéaire, B = comparable à une courbe de freinage exponentielle. Niveau R9, B9 = temps de rotation par inertie de courte durée, ... niveau R1, B1 = temps de rotation par inertie de longue durée, niveau R0 = rotation par inertie non freinée.
2. Temps de rotation par inertie, paramètres  $\curvearrowleft$ <sub>min:sec</sub>. L'intervalle de temps pouvant être réglé dépend de la vitesse de rotation paramétrée.
3. Nombre de tours de l'arrêt de freinage, paramètres n<sup>(\*)</sup>/RPM  
Dès que ce nombre de tours est atteint, la rotation par inertie n'est plus freinée.



1. Valeur nominale de la température, paramètres T/°C. Réglable de -20°C à +40°C, par intervalles de 1°C (réglable de -20°C à +60°C avec l'option Chauffer/refroidir). La température la plus basse pouvant être atteinte dépend du rotor (se reporter au chapitre "Anhang/Appendix, Rotoren und Zubehör/Rotors and accessories").
2. Rayon de centrifugation, paramètres r/mm. Introduction en mm. Pour le rayon de centrifugation, se reporter au chapitre "Anhang/Appendix, Rotoren und Zubehör/Rotors and accessories".

START

1. Démarrer le processus de centrifugation. Affichage de la rotation .
2. Validation de modifications durant le processus de centrifugation.

STOP

Terminer le processus de centrifugation.  
Rotation par inertie du rotor selon les paramètres de rotation par inertie présélectionnés. Le fait d'appuyer deux fois sur la touche déclenche l'arrêt d'urgence.

PROG

Sélectionner la position de programme, paramètres PROG-Nr.

RCL

Récupération de programmes.

STO

Mise en mémoire de programmes.

Il est possible d'enregistrer 89 programmes (positions de programmes 1 à 89). Remarque : les positions de programmes "----" et 90 à 99 servent de mémoire tampon automatique (se reporter au chapitre "Mémoire tampon automatique"). Il est impossible d'enregistrer des programmes à ces positions.



## 20 Saisie des paramètres de centrifugation



La saisie d'un paramètre est uniquement possible lorsque le champ de saisie « inversé » est affiché (arrière-plan de couleur sombre). Un champ de saisie « inversé » disparaît automatiquement, au bout de 10 secondes.

### 20.1 Durée de fonctionnement



#### 20.1.1 Présélection de la durée

- Appuyer sur la touche  autant de fois que nécessaire, jusqu'à ce que le paramètre t/min: ou t/ :sec s'affiche. Le champ de saisie affiché est « inversé ».
- Avec le bouton de réglage , paramétrer la valeur recherchée.



#### 20.1.2 Fonctionnement en continu

- Sélectionner les paramètres t/min: et t/ :sec les uns à la suite des autres (se reporter au chapitre "Présélection de la durée"), et les régler tous deux sur zéro, au moyen du bouton de réglage . "---:--" s'affiche dans le champ de saisie.

### 20.2 Vitesse de rotation (RPM)

- Appuyer sur la touche  autant de fois que nécessaire, jusqu'à ce que le paramètre RPM s'affiche et que le champ de saisie « inversé » apparaisse.
- Avec le bouton de réglage , paramétrer la valeur recherchée.

### 20.3 Accélération relative de centrifugation (RCF/RZB)

- Appuyer sur la touche  autant de fois que nécessaire, jusqu'à ce que le paramètre RCF/RZB s'affiche et que le champ de saisie « inversé » apparaisse.
- Avec le bouton de réglage , paramétrer la valeur recherchée.

Lors du paramétrage, l'affichage du rayon de centrifugation clignote.

### 20.4 Paramètres de démarrage et paramètres de rotation par inertie



Les paramètres de démarrage et les paramètres de rotation par inertie réglés s'affichent.





x: 1-9 = temps de démarrage, t = temps de démarrage

y: R1-R9, B1-B9 = niveau de freinage, R0 = rotation par inertie non freiné, t = temps de rotation par inertie, n<sup>(\*)</sup> = nombre de tours de l'arrêt de freinage

#### 20.4.1 Niveau de démarrage



- Appuyer sur la touche  autant de fois que nécessaire, jusqu'à ce que le paramètre  $\curvearrowright_{1-9}$  ou  $\curvearrowright$  s'affiche. Le champ de saisie affiché est « inversé ».
- A l'aide du bouton de réglage , paramétrer le niveau recherché.

#### 20.4.2 Temps de démarrage

- Appuyer sur la touche  autant de fois que nécessaire, jusqu'à ce que le paramètre  $\curvearrowright_{\text{min:sec}}$  s'affiche. Le champ de saisie affiché est « inversé ».
- Avec le bouton de réglage , paramétrer la valeur recherchée.

Si le temps de démarrage paramétré est supérieur à la durée de fonctionnement, le processus de centrifugation se termine avant que le nombre de tours paramétré soit atteint.



#### 20.4.3 Niveau de freinage

- Appuyer sur la touche  autant de fois que nécessaire, jusqu'à ce que le paramètre  $\curvearrowleft_{0-9}$  ou  $\curvearrowleft$  s'affiche. Le champ de saisie affiché est « inversé ».
- A l'aide du bouton de réglage , paramétrer le niveau recherché.



Les niveaux de freinage B peuvent uniquement être paramétrés pour des rotors spéciaux.

#### 20.4.4 Temps de rotation par inertie

En cas de paramétrage d'un nombre de tours d'arrêt de freinage, il est impossible de paramétrer le temps de rotation par inertie.



- Appuyer sur la touche  autant de fois que nécessaire, jusqu'à ce que le paramètre  $\curvearrowleft_{\text{min:sec}}$  s'affiche. Le champ de saisie affiché est « inversé ».
- Avec le bouton de réglage , paramétrer la valeur recherchée.

#### 20.4.5 Nombre de tours de l'arrêt de freinage

- Appuyer sur la touche  autant de fois que nécessaire, jusqu'à ce que le paramètre  $n^{(s)}/\text{RPM}$  s'affiche. Le champ de saisie affiché est « inversé ».
- Avec le bouton de réglage , paramétrer la valeur recherchée.



### 20.5 Rayon/température

#### 20.5.1 Rayon

- Appuyer sur la touche  autant de fois que nécessaire, jusqu'à ce que le paramètre r/mm s'affiche et que le champ de saisie « inversé » apparaisse.
- Avec le bouton de réglage , paramétrer la valeur recherchée.

En cas de modification du rayon, le programme ajuste automatiquement la valeur RCF/RZB et le signale par un affichage clignotant.

#### 20.5.2 Température

- Appuyer sur la touche  autant de fois que nécessaire, jusqu'à ce que le paramètre T/°C s'affiche et que le champ de saisie « inversé » apparaisse.
- Avec le bouton de réglage , paramétrer la valeur recherchée.

### 20.6 Mémoire tampon automatique

La mémoire tampon comprend les positions de programmes "----" et 90 à 99. Après chaque lancement d'un processus de centrifugation, les données de centrifugation modifiées sont automatiquement enregistrées à la position de programme "----". Les données de centrifugation modifiées des 11 derniers processus de centrifugation sont enregistrées dans la mémoire tampon et peuvent être extraites (se reporter au chapitre "Récupération de programme").

## 21 Programmation

### 21.1 Introduction de programme / modification de programme

- Régler les paramètres recherchés (se reporter au chapitre "Saisie des paramètres de centrifugation").
- Appuyer sur la touche **[PROG]**, pour sélectionner le paramètre PROG-Nr. Le champ de saisie affiché est « inversé ».
- Avec le bouton de réglage **[○]**, paramétrer la position de programme recherchée.  
L'affichage clignotant de la position de programme indique que cette position est déjà occupée par des données de centrifugation. Dans ce cas, paramétrer une position de programme libre ou écraser les données de centrifugation en poursuivant la procédure.
- Appuyer 1x sur la touche **[STO]**, pour enregistrer les paramètres à la position de programme recherchée.  
Appuyer 2x sur la touche **[STO]**, pour écraser des données de centrifugation enregistrées.

### 21.2 Récupération de programme

- Appuyer sur la touche **[PROG]**, pour sélectionner le paramètre PROG-Nr. Le champ de saisie affiché est « inversé ».
- Avec le bouton de réglage **[○]**, paramétrer la position de programme recherchée.
- Appuyer sur la touche **[RCL]**. Les données de centrifugation de la position de programme sélectionnée s'affichent.

## 22 Centrifugation

 Durant un processus de centrifugation, aucune personne, matière dangereuse et aucun objet ne doivent se trouver dans une zone de sécurité de 300 mm autour de la centrifugeuse selon EN / IEC 61010-2-020.

 L'entraînement est stoppé en phase de montée en puissance si la différence de tare admissible a été dépassée pendant le chargement du rotor, et la mention **IMBALANCE / UNWUCHT** est affichée.  
Si la vitesse de rotation du programme sélectionné est supérieure à la vitesse de rotation maximale du rotor (n-max-Rotor), aucun processus de centrifugation ne peut être lancé. Le programme affiche **N > ROTOR MAX 96** (se reporter au chapitre "Défauts").  
La centrifugation peut être stoppée n'importe quand en appuyant sur la touche **[STOP]**.  
Les touches **[R]** et **[RCF]** permettent de commuter à tout moment entre les affichages RPM et RCF. Lorsque le travail est effectué avec l'affichage RCF, il est impératif d'entrer le rayon de centrifugation.  
Après affichage de **≤ OPEN ≤ OEFFNEN** (= OUVRIR) la commande de centrifugeuse n'est possible qu'après avoir ouvert le couvercle une fois.  
Si **R xx n-max xxxxx** est affiché, la marche de centrifugation n'a pas été exécutée en raison du changement du rotor, voir chapitre "Identification de rotor".

- Activer l'interrupteur secteur. Position de l'interrupteur I.
- Charger le rotor et fermer le couvercle de la centrifugeuse.

### 22.1 Centrifugation avec présélection de la durée

- Paramétrer la durée ou appeler un programme avec présélection de la durée (se reporter au chapitre "Saisie des paramètres de centrifugation" ou "Récupération de programme").
- Appuyer sur la touche **[START]**. Le symbole de rotation **⦿** est affiché tant que le rotor tourne.
- Une fois le temps écoulé ou en cas d'interruption du processus de centrifugation par actionnement de la touche **[STOP]**, la rotation par inertie est exécutée selon les paramètres de rotation par inertie sélectionnés. Dès que le rotor s'est immobilisé, le symbole **⏏** clignote à l'écran, jusqu'à ce que le couvercle soit ouvert.

Durant le cycle de centrifugation, la vitesse de rotation du rotor ou la valeur RCF, la température dans la cuve de centrifugeuse et le temps restant s'affichent.

### 22.2 Fonctionnement en continu

- Paramétrer le symbole **---:--** ou appeler un programme de fonctionnement en continu (se reporter au chapitre "Saisie des paramètres de centrifugation" ou "Récupération de programme").
- Appuyer sur la touche **[START]**. Le symbole de rotation **⦿** est affiché tant que le rotor tourne. Le décompte du temps commence à 00:00.
- Appuyer sur la touche **[STOP]**, afin de clôturer le processus de centrifugation. La rotation par inertie est exécutée selon les paramètres de rotation par inertie sélectionnés. Dès que le rotor s'est immobilisé, le symbole **⏏** clignote à l'écran, jusqu'à ce que le couvercle soit ouvert.

Durant le cycle de centrifugation, la vitesse de rotation du rotor ou la valeur RCF, la température dans la cuve de centrifugeuse et le temps écoulé s'affichent.



### 23 Modifier des réglages pendant le processus de centrifugation

La durée de fonctionnement, la vitesse de rotation, l'accélération relative de centrifugation (RCF/RZB), les paramètres de démarrage et de rotation par inertie, ainsi que la température peuvent être modifiés pendant le processus de centrifugation.

Il est possible de modifier les paramètres uniquement individuellement et les uns à la suite des autres.

- Sélectionner le paramètre recherché et modifier la valeur au moyen du bouton de réglage  $\odot$  (se reporter au chapitre "Saisie des paramètres de centrifugation").
- Appuyer sur la touche **START**. Le paramétrage modifié est enregistré à la position de programme "----" (se reporter au chapitre "Mémoire tampon automatique"). Le programme d'origine n'est pas écrasé.

### 24 Integral RCF ( $\int$ RCF)

L'Integral RCF ( $\int$ RCF) est une cote pour l'effet de sédimentation ( $\int n^2 dt$ ). Cette valeur numérique permet de comparer les processus de centrifugation. Pour interroger l'Integral RCF, maintenir la touche **RCF** enfoncée.

### 25 Affichage de la vitesse de rotation maximale du rotor

- Appuyer sur la touche **□** autant de fois que nécessaire, jusqu'à ce que le paramètre RPM s'affiche et que le champ de saisie « inversé » apparaisse.
- Appuyer encore 1x sur la touche **□** et la maintenir enfoncée : la vitesse maximale de rotation du rotor (n-max-Rotor) s'affiche.

### 26 Affichage de la valeur RCF maximale du rotor

- Appuyer sur la touche **RCF** autant de fois que nécessaire, jusqu'à ce que le paramètre RCF/RZB s'affiche et que le champ de saisie « inversé » apparaisse.
- Appuyer encore 1x sur la touche **RCF** et la maintenir enfoncée : la valeur RCF maximale du rotor (RCF-max-Rotor) s'affiche.

### 27 Arrêt d'urgence

- Appuyer 2x sur la touche **STOP**. Le symbole **STOP** clignote à l'écran.

En cas d'arrêt d'urgence, la rotation par inertie est exécutée selon le niveau de freinage R9 (temps de rotation par inertie le plus court). Si le niveau de freinage R0 avait été présélectionné, pour des raisons techniques, le temps de rotation par inertie est plus long qu'avec le niveau de freinage R9.

### 28 Signal acoustique

Le signal acoustique retentit suite au réglage suivant :

<b>OFF</b>	<ul style="list-style-type: none"> <li>• En cas de panne, par intervalles de 2 secondes.</li> </ul>
<b>ON1</b>	<ul style="list-style-type: none"> <li>• En cas de panne, par intervalles de 2 secondes.</li> <li>• Suite à la clôture du processus de centrifugation et à l'immobilisation du rotor, par intervalles de 30 secondes.</li> </ul>
<b>ON2</b>	<ul style="list-style-type: none"> <li>• En cas de panne, par intervalles de 2 secondes.</li> <li>• Suite à la clôture du processus de centrifugation et à l'immobilisation du rotor, par intervalles de 30 secondes.</li> <li>• A chaque actionnement de touche.</li> </ul>

Le fait d'ouvrir le couvercle ou d'appuyer sur n'importe quelle touche annule le signal acoustique.

Lorsque le rotor est immobile, il est possible de régler le signal acoustique de la manière suivante :

- Ouvrir le couvercle.
- Maintenir la touche **□** enfoncée pendant 8 secondes.  
Au bout de 8 secondes, le programme affiche **SOUND / BELL XXX**.
- Au moyen du bouton de réglage  $\odot$ , paramétrer la fonction désirée (OFF, ON1, ON2).
- Appuyer sur la touche **START**, pour enregistrer le paramétrage.  
Le programme affiche brièvement **\*\*\* ok \*\*\***, à titre de confirmation.

## 29 Interrogation relative au nombre d'heures de service

Il est uniquement possible de lancer l'interrogation quant au nombre d'heures de service lorsque le rotor est immobile.

- Ouvrir le couvercle.
- Maintenir la touche **[ ]** enfoncée pendant 8 secondes.  
Au bout de 8 secondes, le programme affiche **SOUND / BELL XXX**.
- Appuyer encore 1x sur la touche **[ ]**.  
Les heures de service (**CONTROL:** ) de la centrifugeuse, s'affichent.  
L'affichage des heures de service disparaît automatiquement au bout de 10 secondes.

## 30 Réglage de la date et de l'heure

Il est uniquement possible de régler la date et l'heure lorsque le rotor est immobile.

- Ouvrir le couvercle.
- Maintenir la touche **[ ]** enfoncée pendant 8 secondes.  
Au bout de 8 secondes, le programme affiche **SOUND / BELL XXX**.
- Appuyer encore 2x sur la touche **[ ]**.  
La date et l'heure s'affichent (a: année, mon: mois, d: jour, h: heure, min: minutes).
- Appuyer sur la touche **[ ]** autant de fois que nécessaire, jusqu'à ce que le champ de saisie du paramètre recherché s'affiche de façon « inversée ».
- Avec le bouton de réglage **[ ]**, paramétrer la valeur recherchée.
- Appuyer sur la touche **[START]**, pour enregistrer le paramétrage.  
Le programme affiche brièvement **\*\*\* ok \*\*\***, à titre de confirmation.
- Pour quitter le paramétrage de la date et de l'heure, appuyer sur n'importe quelle touche, exception faite de les touches **[ ]**, **[ ]** et **[START]**.

## 31 Données de centrifugation, affichées suite à la mise en service

Suite à la mise en service, les données de centrifugation du programme 1 ou du dernier programme utilisé s'affichent. Il est possible de procéder aux réglages suivants :

- Ouvrir le couvercle.
- Désactiver l'interrupteur secteur, puis l'activer de nouveau. Position de l'interrupteur **I**.
- Dès la première transformation optique visible à l'écran (affichage « inversé »), appuyer sur la touche **[STOP]**.  
Le programme affiche **PROGRAM 1, LAST PROGRAM**.
- Au moyen du bouton de réglage **[ ]**, paramétrer la fonction désirée.
- Appuyer sur la touche **[START]**, pour enregistrer le paramétrage.  
Le programme affiche brièvement **\*\*\* ok \*\*\***, à titre de confirmation.

## 32 Affichage immédiat des données de centrifugation suite à la mise en service

- Activer l'interrupteur secteur. Position de l'interrupteur **I**.
- Dès la première transformation optique visible à l'écran (affichage « inversé »), appuyer sur n'importe quelle touche, exception faite de la touche **[STOP]**. Les données de centrifugation s'affichent instantanément.

## 33 Interrupteur à clé

L'interrupteur à clé permet de paramétrer les verrouillages de programmes suivant :

Position de l'interrupteur vers la gauche :	<b>LOCK 1</b> s'affiche. Les programmes peuvent uniquement être appelés et non pas modifiés.
Position de l'interrupteur vers la droite :	<b>LOCK 2</b> s'affiche. Aucun programme ne peut être appelé ni modifié.
Position de l'interrupteur au centre :	Pas d'affichage d'état. Aucun verrouillage du programme. Il est possible d'appeler les programmes et de les modifier.

## 34 Création de liens entre programmes (uniquement dans le cas de centrifugeuses dotées de la fonction de création de liens entre programmes)

Les liens entre programmes permettent de combiner plusieurs processus de centrifugation entre eux.

### 34.1 Créer des liens entre programmes



Il est uniquement possible de créer des liens entre les programmes pour lesquels les niveaux de démarrage et de freinage ont été paramétrés.

Avant la création des liens, les programmes doivent être enregistrés dans l'ordre chronologique désiré, soit au moyen de la fonction d'introduction de programmes, soit au moyen de la fonction de récupération de programmes (se reporter au chapitre "Programmation").

Les positions de programmes doivent être ordonnées les unes à la suite des autres (par exemple : positions de programmes 10+11+12).

1. Appuyer sur la touche **PROG**, pour sélectionner le paramètre PROG-Nr. Le champ de saisie affiché est « inversé ».
2. Au moyen du bouton de réglage  $\bar{O}$ , paramétrer la position du programme initial (XX+).
3. Appuyer sur la touche **RCL**. Les données de centrifugation de la position de programme sélectionnée s'affichent.
4. Appuyer 2x sur la touche **PROG**, pour sélectionner le paramètre PR-PART. Le champ de saisie affiché est « inversé ».
5. Appuyer 2x sur la touche **STO**. Le programme est enchaîné et le numéro de programme de la position suivante (+XX+) s'affiche.
6. Appuyer 2x sur la touche **RCL**. Les données de centrifugation de la position de programme sélectionnée s'affichent.
7. Appuyer 2x sur la touche **STO**. Le programme est enchaîné et le numéro de programme de la position suivante (+XX+) s'affiche.
8. Répéter les étapes 6 et 7 aussi souvent que nécessaire, jusqu'à ce que tous les programmes soient enchaînés.
9. Pour clore la procédure, appuyer sur la touche **PROG**. Le numéro de programme du programme final (+XX) s'affiche.

### 34.2 Modifier les liens entre programmes

- Extraire le programme recherché (se reporter au chapitre "Récupération de programme"), modifier les paramètres désirés (se reporter au chapitre "Saisie des paramètres de centrifugation"), puis enregistrer les données de centrifugation modifiées à la même position de programme (se reporter au chapitre "Introduction de programme / modification de programme"). L'enregistrement annule le lien entre programmes.
- Reconstituer les liens entre les programmes (se reporter au chapitre "Créer des liens entre programmes").

### 34.3 Processus de centrifugation avec lien entre programmes

- Appuyer 2x sur la touche **PROG**, pour sélectionner le paramètre PR-PART. Le champ de saisie affiché est « inversé ».
  - Au moyen du bouton de réglage  $\bar{O}$ , paramétrer la position du programme initial (XX+).
  - Appuyer sur la touche **RCL**. Les données de centrifugation de la position de programme sélectionnée s'affichent.
  - Appuyer sur la touche **START**. Le symbole de rotation  $\odot$  est affiché tant que le rotor tourne.
- Les niveaux de démarrage et de freinage du lien des programmes s'affichent :

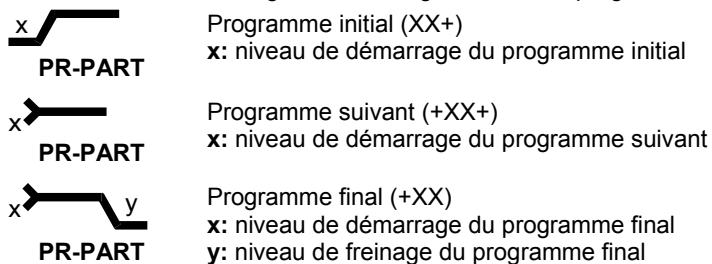

- Dès que le temps paramétré pour le programme final est écoulé, la rotation par inertie est exécutée avec le niveau de freinage du programme final. En cas d'interruption du processus de centrifugation par actionnement de la touche **STOP**, la rotation par inertie est exécutée avec le niveau de freinage du programme courant.

### 34.4 Effacer des liens entre programmes

- Appuyer sur la touche **PROG**, pour afficher le paramètre PROG-Nr. Le champ de saisie affiché est « inversé ».
- Au moyen du bouton de réglage  $\bar{O}$ , paramétrer la position du programme initial (XX+).
- Appuyer sur la touche **RCL**. Les données de centrifugation de la position de programme sélectionnée s'affichent.
- Appuyer 2x sur la touche **PROG**, pour afficher le paramètre PR-PART. Le champ de saisie affiché est « inversé ».
- Appuyer 2x sur la touche **STO**.
- Appuyer sur la touche **PROG**.

### 35 Refroidissement

La température de consigne peut être réglée sur une plage de -20 °C à +40 °C. Pour les centrifugeuses équipées de l'option Chauffer/refroidir, la valeur prescrite de la température est réglable de -20°C à +60°C. Le minimum de température possible est fonction du rotor (voir le Chapitre "Anhang/Appendix, Rotoren und Zubehör/Rotors and accessories"). Si la différence entre la température actuelle et la température de consigne dépasse 5°C, ceci est signalée par un clignotement de l'affichage de température.

#### 35.1 Refroidissement en veilleuse

À l'arrêt du rotor et lorsque le couvercle est fermé, le bol de centrifugeuse est refroidi à la température sélectionnée. La température de consigne est indiquée sur l'afficheur.

#### 35.2 Pré-refroidissement du rotor

Afin de garantir une prérefrigération rapide du rotor à l'état non chargé et des accessoires utilisés, il est recommandé de sélectionner un processus de centrifugation avec les paramétrages du fonctionnement en continu et une vitesse de rotation d'environ 20% de la vitesse de rotation maximale du rotor.

### 36 Chauffage

Au cours du fonctionnement de centrifugation, en cas de besoin, la zone de centrifugation peut être chauffée à une température pré-sélectionnée.

Lorsque le rotor est au point mort, le chauffage est éteint.



Risque de brûlure ! La température de surface de l'élément chauffant dans le compartiment de centrifugation de la centrifugeuse peut monter jusqu'à 500 °C / 932 °F. Ne pas toucher l'élément chauffant.

### 37 Accélération centrifuge relative (RCF)

L'accélération centrifuge relative (RCF) est indiquée en tant que multiple de l'accélération gravitationnelle (g). Il s'agit d'une valeur dépourvue d'unité, qui sert à la comparaison entre la puissance de séparation et de sédimentation.

Le calcul s'effectue à l'aide de la formule suivante:

$$\text{RCF} = \left( \frac{\text{RPM}}{1000} \right)^2 \times r \times 1,118 \quad \Rightarrow \quad \text{RPM} = \sqrt{\frac{\text{RCF}}{r \times 1,118}} \times 1000$$

RCF = accélération centrifuge relative

RPM = régime

r = rayon de centrifugation en mm = distance qui sépare le centre de l'axe de rotation du fond de la cuve de centrifugation. Rayon de centrifugation voir chapitre "Anhang/Appendix, Rotoren und Zubehör/Rotors and accessories".



L'accélération centrifuge relative (RCF) est dépendante du régime et du rayon de centrifugation.

### 38 Centrifugation de matières et de mélanges d'une densité supérieure à 1,2 kg/dm<sup>3</sup>

Dans le cas de la centrifugation à la vitesse maximale, la densité des substances et des mélanges de substances ne doit pas excéder 1,2 kg/dm<sup>3</sup>. Réduire la vitesse de rotation pour les matières et mélanges ayant une densité supérieure.

La vitesse de rotation autorisée se calcule de la manière suivante:

$$\text{Vitesse de centrifugation lente (n}_{\text{red}}) = \sqrt{\frac{1,2}{\text{densité supérieure [kg/dm}^3]}} \times \text{Vitesse de rotation maximum [RPM]}$$

Exemple: Vitesse de rotation maximum RPM 4000, densité 1,6 kg/dm<sup>3</sup>

$$n_{\text{red}} = \sqrt{\frac{1,2 \text{ kg/dm}^3}{1,6 \text{ kg/dm}^3}} \times 4000 \text{ RPM} = 3464 \text{ RPM}$$

Dans le cas exceptionnel de dépassement de la charge maximum indiquée sur la suspension, réduire également la vitesse de rotation.

La vitesse de rotation autorisée se calcule de la manière suivante:

$$\text{Vitesse de centrifugation lente (n}_{\text{red}}) = \sqrt{\frac{\text{Charge maximum [g]}}{\text{Charge réelle [g]}}} \times \text{Vitesse de rotation maximum [RPM]}$$

Exemple: Vitesse de rotation maximum RPM 4000, Charge maximum 300 g, Charge réelle 350 g

$$n_{\text{red}} = \sqrt{\frac{300 \text{ g}}{350 \text{ g}}} \times 4000 \text{ RPM} = 3703 \text{ RPM}$$

En cas d'incertitude, prendre contact avec le fabricant.

### 39 Identification du rotor

Une identification du rotor est effectuée après le démarrage de chaque cycle de centrifugation.

Si le rotor a été remplacé, le cycle de centrifugation s'interrompt après l'identification du rotor. L'afficheur indique le code (R xx) et la vitesse de rotation maximale (n-max=xxxxx) du rotor.



Toute commande ultérieure de la centrifuge n'est possible qu'après une ouverture du couvercle.

Si la vitesse de rotation maximale du rotor utilisé est inférieure à la vitesse de rotation paramétrée, la vitesse de rotation effective est limitée à la vitesse de rotation maximale du rotor.

### 40 Déverrouillage d'urgence

En cas de panne de courant, le couvercle ne peut pas être déverrouillé avec le moteur. Il est nécessaire d'exécuter un déverrouillage manuel.



Avant d'exécuter le déverrouillage manuel, retirer la fiche de l'alimentation. Dans le cas des appareils reliés de manière rigide, éteindre l'interrupteur de secteur pour couper l'alimentation secteur de l'appareil dans l'installation du bâtiment et empêcher une remise en marche, par ex. en verrouillant l'interrupteur.

Attendre que le rotor est à l'arrêt pour ouvrir le couvercle.

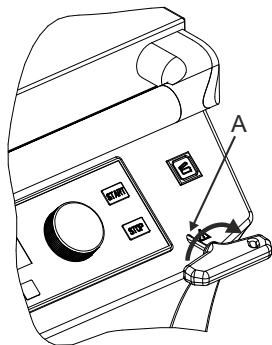

- Débranchez la tension du réseau en mettant l'interrupteur en position "0".
- Regarder par la fenêtre située sur le couvercle pour s'assurer que le rotor est immobile.
- Insérer horizontalement la clé mâle coudée à six pans creux dans l'orifice (A) et tourner avec précaution d'un demi-tour dans le sens des aiguilles d'une montre jusqu'à ce que le couvercle puisse être ouvert.
- Retirer la clé à six pans hors de l'alésage.
- Après avoir remis la centrifugeuse sous tension, appuyer sur la touche  pour ramener le verrouillage de couvercle automatique en position initiale (ouvert).

## 41 Entretien et maintenance



L'appareil est peut-être contaminé.



Retirer la prise de secteur avant de nettoyer. Dans le cas des appareils reliés de manière rigide, éteindre l'interrupteur de secteur pour couper l'alimentation secteur de l'appareil dans l'installation du bâtiment et empêcher une remise en marche, par ex. en verrouillant l'interrupteur.

Avant d'utiliser une procédure de nettoyage ou de décontamination autre que celle recommandée par le fabricant, l'utilisateur vérifiera auprès du fabricant que la procédure prévue n'endommage pas l'appareil.

- Ne pas nettoyer centrifuges, rotors et accessoires dans un lave-vaisselle.
- Seul le nettoyage manuel et une désinfection liquide sont autorisés.
- La température de l'eau doit être située entre 20 et 25°C.
- Utiliser exclusivement des agents de nettoyage ou de désinfection qui :
  - ont un pH de 5 à 8,
  - ne contiennent pas de substances caustiques, de peroxyde, composés chlorés, acides ni alcalins.
- Respecter impérativement les consignes spéciales d'utilisation données par le fabricant des agents de nettoyage et de désinfection, afin de prévenir la corrosion par les agents de nettoyage et de désinfection.

### 41.1 Centrifugeuse (boîtier, couvercle et cuve)

#### 41.1.1 Entretien et nettoyage des surfaces

- Nettoyer régulièrement le boîtier de la centrifugeuse et le compartiment de centrifugation et les laver en cas de besoin avec du savon ou un détergent doux et un chiffon humide. Ces opérations sont nécessaires pour garantir l'hygiène et pour prévenir la corrosion par la présence durable d'impuretés.
- Substances des nettoyeurs adéquats :  
savon, agents anioniques et non ioniques.
- Après utilisation des nettoyeurs, enlevez les résidus en essuyant l'appareil avec un chiffon humide.
- Séchez immédiatement les surfaces après nettoyage.
- Sécher le bol avec un chiffon absorbant en cas de dépôt d'eau de condensation dans le bol de la centrifugeuse.
- Frotter légèrement le joint d'étanchéité en caoutchouc du compartiment de centrifugation, après chaque nettoyage, avec un produit d'entretien pour caoutchouc.
- Vérifiez tous les ans le bon état de la cuve.



N'utilisez plus la centrifugeuse si elle présente des dommages susceptibles de porter atteinte à la sécurité. Auquel cas, contactez le service après-vente.

#### 41.1.2 Désinfection des surfaces

- Le bol de la centrifugeuse doit être nettoyé immédiatement dans le cas où un matériau infectieux a pénétré dans le bol de la centrifugeuse.
- Substances des désinfectants adéquats :  
éthanol, n-propanol, éthylènehexanol, agents anioniques, inhibiteurs de corrosion.
- Après utilisation de désinfectants, enlevez les résidus en essuyant l'appareil avec un chiffon humide.
- Séchez immédiatement les surfaces après désinfection.

#### 41.1.3 Décontamination de substances radioactives

- L'agent employé doit expressément convenir pour une décontamination de substances radioactives.
- Substances des agents adaptés à une décontamination des substances radioactives :  
agents anioniques, non ioniques agents, éthanol polyhydre.
- Après décontamination des substances radioactives, enlevez les résidus en essuyant l'appareil avec un chiffon humide.
- Séchez immédiatement les surfaces après décontamination des substances radioactives.

## 41.2 Rotors et accessoires

### 41.2.1 Nettoyage et entretien

- Afin de prévenir la corrosion et toute modification des matériaux, il faut nettoyer régulièrement les rotors et les accessoires avec du savon ou un détergent doux et un chiffon humide. Il est vivement recommandé d'effectuer un nettoyage au moins une fois par semaine. Enlevez immédiatement les impuretés.
- Substances des nettoyants adéquats :  
savon, agents anioniques et non ioniques.
- Après utilisation de nettoyants, enlevez les résidus en rinçant à l'eau claire (uniquement à l'extérieur de la centrifugeuse) ou en essuyant les surfaces avec un chiffon humide.
- Séchez rotors et accessoires immédiatement après nettoyage.
- Après séchage, les rotors d'angle, les réservoirs et la suspension en aluminium seront enduits d'une pellicule de graisse sans acide, par exemple la vaseline.
- Nettoyer une fois par semaine les bagues d'étanchéité des systèmes de biosécurité.  
Les bagues d'étanchéité sont fabriquées en silicone. Afin de garantir l'étanchéité des systèmes de biosécurité, ne pas traiter les bagues d'étanchéité, après leur nettoyage ou autoclave, avec du talc en poudre. Avant toute utilisation du système de biosécurité, vérifier par un contrôle visuel le bon état de chaque pièce du système de biosécurité. En outre, vérifier la position correcte de, ou des bagues d'étanchéité du système de biosécurité.

Remplacer sans plus attendre toute pièce défectueuse du système de biosécurité.

Remplacer immédiatement toute bague d'étanchéité présentant des signes de formation de fissure, de fragilisation ou d'usure. Remplacer tout le couvercle en cas de couvercle ayant des bagues d'étanchéité non remplaçables.

Vous trouverez au chapitre "Annexe/Appendix, rotors et accessoires/Rotors and accessories" la liste des systèmes de biosécurité pouvant être livrés.

- Déposer le rotor au moins une fois par mois, nettoyer et enduire l'arbre d'entraînement d'une pellicule de graisse pour prévenir la corrosion par la présence d'humidité entre le rotor et l'arbre d'entraînement.
- Vérifier une fois par semaine l'état des rotors et des accessoires afin de détecter les éventuelles détériorations issues de l'usure et l'oxydation.

Pour les rotors à oscillation, vérifier surtout la zone de portée des tourillons et pour les balanciers, vérifier les rainures et le fond pour détecter les éventuelles fissures.

Exemple : fissures dans la rainure.

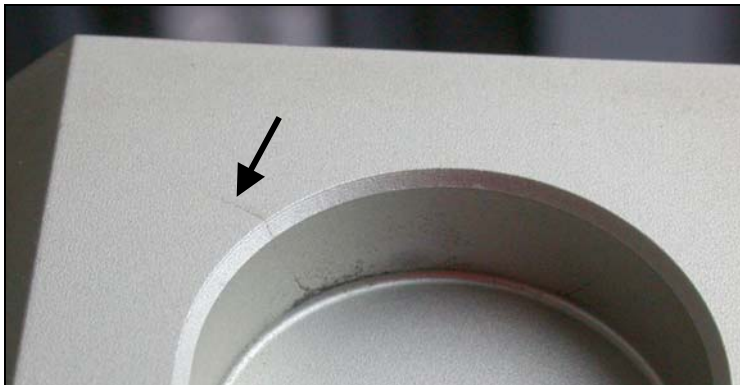

Les rotors et les accessoires usés et endommagés par la corrosion ne doivent plus être utilisés.

- Vérifier chaque semaine la stabilité de fixation du rotor.

### 41.2.2 Désinfection

- Si les rotors ou accessoires sont infectés, procédez à une désinfection appropriée.
- Substances des désinfectants adéquats :  
éthanol, n-propanol, éthylènehexanol, agents anioniques, inhibiteurs de corrosion.
- Après utilisation de désinfectants, enlevez les résidus en rinçant à l'eau claire (uniquement à l'extérieur de la centrifugeuse) ou en essuyant les surfaces avec un chiffon humide.
- Séchez rotors et accessoires immédiatement après désinfection.

#### 41.2.3 Décontamination de substances radioactives

- L'agent employé doit expressément convenir pour une décontamination de substances radioactives.
- Substances des agents adaptés à une décontamination des substances radioactives : agents anioniques, agents non ioniques, éthanol polyhydre.
- Après décontamination des substances radioactives, enlevez les résidus en rinçant à l'eau claire (uniquement à l'extérieur de la centrifugeuse) ou en essuyant les surfaces avec un chiffon humide.
- Séchez immédiatement rotors et accessoire après décontamination des substances radioactives.

#### 41.2.4 Goupilles de fixation

Les goupilles de fixation des rotors à amortissement doivent être graissées régulièrement (graisse de lubrification Hettich n° 4051) de manière à assurer le balancement régulier de la suspension.

#### 41.2.5 Rotors et accessoires à durée d'utilisation limitée

L'utilisation de certains rotors, balanciers et accessoires est limitée dans le temps.

Ces limites sont indiquées par le nombre maximum de cycles ou la date limite d'utilisation et le nombre maximum de cycles, ou simplement la date limite d'utilisation, par ex. :

- "einsetzbar bis Ende: IV. Quartal 2011 / usable until end of: IV. trimestre 2011" (utilisation autorisée jusqu'à fin: IV. trimestre 2011) ou  
"einsetzbar bis Ende Monat/Jahr: 10/2011 / usable until end of month/year: 10/2011" (utilisation autorisée jusqu'à fin mois/an : 10/2011)
- "max. Laufzyklen / max. cycles: 40000" (nombre ma. de cycles 40000)



Pour des raisons de sécurité, l'utilisation de rotors, balanciers et accessoires n'est plus autorisée dès que le nombre maximum de cycles désigné ou la date limite d'utilisation inscrite sont atteints.

#### 41.2.6 Calcul du nombre de cycles exécutés

Pour calculer le nombre de cycles (de centrifugation) réalisés, il faut connaître la durée de chaque cycle de centrifugation et des heures de service de l'appareil.

Pour connaître le nombre d'heures de service, reportez-vous au chapitre "Demande heures de service".

Si les cycles de centrifugation exécutés n'ont pas tous la même durée, prenez le cycle le plus court pour le calcul.

On calcule le nombre de cycles (de centrifugation) réalisés comme suit :

Nombre de cycles exécutés= heures de service (h) x 60 ÷ durée du cycle (min)

par ex. : Heures de service 2000 h, durée du cycle 5 min

Nombre de cycles exécutés= 2000 x 60 ÷ 5 = 24000



### 41.3 Autoclave

Vous pouvez stériliser par autoclave à 121°C / 250°F (20 min) les accessoires suivants:

- rotors à oscillation
- rotors angulaires en aluminium
- balancier en métal
- couvercle avec bio-étanchéité
- adaptateur

Nous ne pouvons faire aucune déclaration sur le degré de stérilisation.



Avant autoclave, retirez les couvercles des rotors et réservoirs.

La stérilisation en autoclave accélère le processus de vieillissement des matières plastiques. Elle peut également modifier la couleur des plastiques.

Après autoclave, vérifier si les rotors et accessoires sont en bon état (contrôle visuel), remplacer immédiatement toute pièce éventuellement défectueuse.

Remplacer immédiatement toute bague d'étanchéité présentant des signes de formation de fissure, de fragilisation ou d'usure.

Remplacer tout le couvercle en cas de couvercle ayant des bagues d'étanchéité non remplaçables.

Afin de garantir l'étanchéité des systèmes de biosécurité, ne pas traiter les bagues d'étanchéité, après autoclave, avec du talc en poudre.

### 41.4 Réservoirs de centrifugation

- En cas de fuite ou de rupture de récipients de centrifugation, il faut éliminer tous les morceaux de récipients cassés, les fragments de verre et les substances centrifugées écoulées.
- Les amortisseurs antivibrations ainsi que les caoutchouc intermédiaires des rotors doivent être remplacés après un bris de verre.



Les fragments de verre restants peuvent entraîner d'autres bris de verre !

- S'il s'agit d'un matériau infectieux, exécuter immédiatement une désinfection.

## 42 Défauts

Si l'erreur ne peut pas être éliminée d'après le tableau des défauts, il faut alors avertir le service après-vente.

Veillez indiquer le type de centrifuge et le numéro de série. Les deux numéros sont indiqués sur la plaque signalétique de la centrifugeuse.

-  Effectuer une RÉINITIALISATION DU SECTEUR :
- Couper l'interrupteur de secteur (position de l'interrupteur "0").
  - Attendre au moins 10 secondes et refermer ensuite l'interrupteur de secteur (position de l'interrupteur "I").

Message / Erreur		Origine	Solution
Pas de message	---	Pas de tension Déclenchement du fusible protecteur contre surintensité	<ul style="list-style-type: none"> <li>- Contrôler la tension d'alimentation</li> <li>- Secteur en marche</li> </ul>
TACHO - ERROR	01	Tachymètre défectueux.	<ul style="list-style-type: none"> <li>- Ouvrir le couvercle.</li> <li>- Couper l'interrupteur de secteur (position de l'interrupteur "0").</li> <li>- Attendre au moins 10 secondes.</li> <li>- Tourner vigoureusement le rotor à la main.</li> <li>- Refermer l'interrupteur de secteur (position de l'interrupteur "I"). Le rotor doit fonctionner pendant la mise en marche.</li> </ul>
	02	Absence de rotor. Moteur, convertisseur, entraînement défectueux.	
IMBALANCE / UNWUCHT	---	Le rotor est chargé de manière non symétrique.	<ul style="list-style-type: none"> <li>- Ouvrir le capot.</li> <li>- Vérifier le chargement du rotor, voir au chapitre "Chargement du rotor".</li> <li>- Répéter le cycle de centrifugation.</li> </ul>
CONTROL - ERROR	04, 06 - 09	Erreur du verrouillage ou de la fermeture du capot.	<ul style="list-style-type: none"> <li>- Effectuer une RÉINITIALISATION DU SECTEUR.</li> </ul>
N > MAX	05	Survitesse	
N < MIN	13	Vitesse trop basse	
ROTORCODE	10	Erreur codage du rotor	
MAINS INTERRUPT	---	Interruption du secteur pendant le cycle de centrifugation. (Le cycle de centrifugation n'est pas terminé.)	<ul style="list-style-type: none"> <li>- Ouvrir le capot.</li> <li>- Appuyer sur la touche <b>START</b>.</li> <li>- En cas de besoin, répéter le cycle de centrifugation.</li> </ul>
VERSIONS-ERROR	12	Pas de correspondance entre les composants électroniques	<ul style="list-style-type: none"> <li>- Effectuer une RÉINITIALISATION DU SECTEUR.</li> </ul>
SER I/O - ERROR	30 - 38	Erreur / défectuosité de l'interface	
° C * - ERROR	50 - 56, 58	Erreur / défectuosité du refroidissement	
LOCK - ERROR	57	Erreur / défectuosité verrouillage du programme	
FU / CCI - ERROR	60 - 83	Erreur / défectuosité de la commande du moteur	
CONTROL-ERROR	26, 90 - 95, 97 - 99	Erreur / défectuosité de la commande	
N > ROTOR-MAX	96	Vitesse de rotation paramétrée dans le programme sélectionné supérieure à la vitesse maximale de rotation du rotor (n-max-Rotor).	<ul style="list-style-type: none"> <li>- Corriger la vitesse du programme sélectionnée</li> </ul>
		Le rotor a été remplacé. Le rotor actuellement en place a une vitesse de rotation maximale supérieure à celle du rotor utilisé précédemment et il n'a pas encore été identifié par l'identification du rotor.	<ul style="list-style-type: none"> <li>- Paramétrer une vitesse de rotation inférieure ou égale à la vitesse de rotation maximale du rotor utilisé précédemment. Appuyer sur la touche <b>START</b> pour procéder à l'identification du rotor, voir chapitre "Identification du rotor".</li> </ul>

### 43 Renvoi d'appareils au fabricant

Dans le cas où l'appareil ou ses accessoires doivent être retournés à la société Andreas Hettich GmbH & Co. KG, il faut les décontaminer et les nettoyer avant expédition, dans le but d'assurer la protection des personnes, de l'environnement et du matériel.

Nous nous réservons le droit de refuser des appareils ou des accessoires contaminés.

Nous facturons au client les frais de nettoyage et de désinfection.

Vous voudrez bien manifester votre compréhension pour cette réglementation.

### 44 Mise au rebut



#### L'appareil peut être éliminé par le fabricant.

Pour un retour, il faut toujours demander un formulaire de retour (RMA).

Si nécessaire, contactez le service technique du fabricant :

Andreas Hettich GmbH & Co. KG

Föhrenstraße 12

78532 Tuttlingen, Allemagne

Tél. : +49 7461 705 1400

E-mail : [service@hettichlab.com](mailto:service@hettichlab.com)

Des frais d'élimination peuvent s'appliquer.



#### AVERTISSEMENT

#### Risque de pollution et de contamination pour les personnes et l'environnement

L'élimination incorrecte ou inappropriée de la centrifugeuse peut provoquer une pollution ou une contamination des personnes et de l'environnement.

- Le démontage et l'élimination ne doivent être effectués que par un spécialiste du service après-vente formé et agréé.

L'appareil est destiné à un usage professionnel (« Business to Business » - B2B).

Conformément à la directive 2012/19/UE, les appareils ne doivent plus être éliminés avec les déchets ménagers.

Les appareils sont classés dans les groupes suivants selon la fondation Elektro-Altgeräte Register (EAR).

- Groupe 1 (échangeurs de chaleur)



Le symbole de la poubelle barrée indique que l'appareil ne doit pas être éliminé avec les déchets ménagers.

Les réglementations en matière d'élimination des déchets peuvent varier d'un pays à l'autre. En cas de besoin, adressez-vous au fournisseur.

**Indice**

1	Impiego di queste istruzioni per l'uso.....	111
2	Significato dei simboli .....	111
3	Conformità di impiego.....	112
4	Rischi residui .....	112
5	Dati tecnici.....	113
6	Indicazioni inerenti la sicurezza .....	115
7	Disimballaggio e collocamento della centrifuga .....	117
8	Contenuto della fornitura .....	117
9	Trasporto ed immagazzinaggio.....	118
9.1	Trasporto.....	118
9.2	Immagazzinaggio .....	118
10	Messa in funzione .....	118
11	Interfaccia (solo per la centrifuga con interfaccia) .....	119
12	Apertura e chiusura del coperchio.....	119
12.1	Apertura del coperchio.....	119
12.2	Chiusura del coperchio .....	119
13	Installazione e disinstallazione del rotore .....	119
14	Applicare ed estrarre i ganci dal rotore.....	120
15	Applicare ed estrarre dai ganci l'adattatore .....	120
16	Carico del rotore.....	121
17	Chiudere i sistemi biologici di sicurezza .....	122
18	Istruzioni HettLiner per imballaggio .....	123
18.1	Imballaggio prima della centrifugazione.....	123
18.2	Disimballare dopo la centrifugazione .....	124
19	Elementi di comando e visualizzazione.....	125
19.1	Indicatori di stato.....	125
19.2	Manopola .....	125
19.3	Tasti e possibilità di regolazione .....	125
20	Immettere i parametri di centrifugazione .....	126
20.1	Tempo ciclo.....	126
20.1.1	Preselezione del tempo .....	126
20.1.2	Funzionamento continuo.....	126
20.2	Numero di giri (RPM) .....	126
20.3	Accelerazione centrifuga relativa (RCF/RZB) .....	126
20.4	Parametri di avviamento e arresto .....	126
20.4.1	Livello di avviamento .....	126
20.4.2	Tempo di avviamento .....	127
20.4.3	Livello di frenatura .....	127
20.4.4	Tempo di arresto.....	127
20.4.5	Numero di giri per la disattivazione frenatura.....	127
20.5	Raggio/Temperatura .....	127
20.5.1	Raggio .....	127
20.5.2	Temperatura .....	127

20.6	Memoria temporanea automatica .....	127
21	Programmazione .....	127
21.1	Impostazione/modifica del programma .....	127
21.2	Richiamo del programma .....	128
22	Centrifugazione .....	128
22.1	Centrifugazione con preselezione del tempo .....	128
22.2	Funzionamento continuo .....	128
23	Modifica delle impostazioni durante il ciclo di centrifugazione .....	128
24	Integrale RCF (JRCF) .....	129
25	Visualizzazione del numero dei giri massimo del rotore .....	129
26	Visualizzazione del RCF massimo del rotore .....	129
27	Arresto di emergenza .....	129
28	Segnale acustico .....	129
29	Interrogazione delle ore di esercizio .....	129
30	Impostazione della data e dell'ora .....	130
31	Dati di centrifugazione visualizzati dopo l'accensione .....	130
32	Visualizzazione immediata dei dati di centrifugazione dopo l'accensione .....	130
33	Interruttore a chiave .....	130
34	Collegamento di programma (solo nelle centrifughe con collegamento di programma) .....	131
34.1	Collegare i programmi .....	131
34.2	Modifica del collegamento di programma .....	131
34.3	Ciclo di centrifugazione con collegamento di programma .....	131
34.4	Cancellazione del collegamento di programma .....	131
35	Raffreddamento .....	132
35.1	Raffreddamento-Standby .....	132
35.2	Pre-raffreddamento del rotore .....	132
36	Riscaldamento .....	132
37	Accelerazione centrifuga relativa (RCF) .....	132
38	Centrifugazione di sostanze o di miscele di sostanze con densità maggiore di 1,2 kg/dm <sup>3</sup> .....	133
39	Riconoscimento del rotore .....	133
40	Sblocco di emergenza .....	133
41	Pulizia e manutenzione .....	134
41.1	Centrifughe (scatola, coperchio e vano di centrifugazione) .....	134
41.1.1	Cura e pulizia delle superfici .....	134
41.1.2	Disinfezione delle superfici .....	134
41.1.3	Rimuovere contaminazioni radioattive .....	134
41.2	Rotori ed accessori .....	135
41.2.1	Pulizia e cura .....	135
41.2.2	Disinfezione .....	135
41.2.3	Rimuovere contaminazioni radioattive .....	136
41.2.4	Perni di trascinamento .....	136
41.2.5	Rotori ed accessori con limitata durata di impiego .....	136
41.2.6	Calcolo della quantità dei cicli operativi eseguiti .....	136
41.3	Trattamento in autoclave .....	137
41.4	Contenitori centrifuga .....	137

---

42	Guasti.....	138
43	Rispedizione di apparecchi .....	139
44	Smaltimento .....	139
45	Anhang / Appendix.....	140
45.1	Rotoren und Zubehör / Rotors and accessories.....	140

## 1 Impiego di queste istruzioni per l'uso

- Lisez et respectez impérativement les consignes et indications contenues dans le mode d'emploi avant d'utiliser la centrifugeuse.
- Le mode d'emploi fait partie intégrante de l'appareil. Vous devez le conserver de manière à toujours être à portée de main.
- Si vous changez l'appareil de place, le mode d'emploi doit suivre l'appareil.

## 2 Significato dei simboli



Simbolo sull'apparecchio:  
Attenzione, punto pericoloso generico.



Simbolo sull'apparecchiatura:  
Prestare attenzione alle istruzioni per l'uso.  
Questo simbolo indica che l'utente deve prestare attenzione alle istruzioni per l'uso fornite.



Simbolo in questo documento.  
Attenzione, punto pericoloso generico.  
Questo simbolo contraddistingue le avvertenze relative alla sicurezza e indica situazioni potenzialmente pericolose.  
La mancata osservanza di tali avvertenze può causare danni materiali e personali.



Simbolo sull'apparecchiatura ed in questo documento:  
Attenzione: rischio biologico.



Simbolo sull'apparecchiatura ed in questo documento:  
Attenzione alle superfici molto calde.  
Il mancato rispetto di questa avvertenza può portare a danneggiamenti alle cose e alle persone.



Simbolo sull'apparecchiatura:  
Equipotenziale: connettore a spina (connettore PA) per collegamento equipotenziale (solo nelle centrifughe con connettore PA).



Simbolo sull'apparecchiatura:  
Posizioni dell'interruttore a chiave.



Simbolo sull'apparecchiatura:  
Interfaccia ottica (solo per la centrifuga con interfaccia ottica).



Simbolo in questo documento:  
Questo simbolo indica argomenti importanti.



Simbolo sull'apparecchiatura ed in questo documento:  
Simbolo per la raccolta separata delle apparecchiature elettriche ed elettroniche, in conformità alle direttive 2012/19/EU.  
Impiego nelle nazioni dell'Unione Europea, in Norvegia ed in Svizzera.



Simbolo sull'imballaggio:  
Questo lato in alto.



Simbolo sull'imballaggio:  
L'imballaggio di trasporto è da immagazzinare, trasportare e manipolare esclusivamente nell'indicato range di umidità dell'aria (10% - 80%).

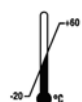

Simbolo sull'imballaggio:  
L'imballaggio di spedizione è da immagazzinare, trasportare e manipolare esclusivamente nell'indicato range di temperatura (-20°C - +60°C).



Simbolo sull'imballaggio:

L'imballaggio di trasporto non deve venir esposto alla pioggia e deve venir conservato in ambiente asciutto.



Simbolo sull'imballaggio:

Fragile, trattare con cautela.



Simbolo sull'imballaggio:

Limite di impilamento. Numero massimo di colli identici che è consentito impilare su quello più in basso, laddove con "n" si intende il numero di colli consentiti. Il collo più in basso non è compreso nel numero "n".

### 3 Conformità di impiego

Il presente dispositivo è una centrifuga da laboratorio adatta ad applicazioni mediche.

La sola destinazione d'uso terapeutico consiste nella centrifugazione di sangue in sistemi per sacche di sangue. I componenti del sangue separati vengono trasferiti da un altro dispositivo (separatore) nelle corrispondenti sacche satellite. I singoli componenti così ottenuti vengono poi utilizzati per la trasfusione o l'autotrasfusione.

La centrifuga può essere utilizzata solo da personale qualificato nei servizi di trasfusione o negli ospedali.

La centrifuga è destinata solo agli usi summenzionati.

Qualsiasi altra forma di utilizzo è da considerarsi non conforme. La ditta Andreas Hettich GmbH & Co. KG è responsabile per i danni eventualmente risultanti.

L'uso previsto comprende anche l'osservanza di tutte le istruzioni del manuale d'uso e il rispetto degli intervalli di ispezione e manutenzione.

### 4 Rischi residui

L'apparecchio è costruito secondo lo stato attuale della tecnica e le regole riconosciute riguardanti la tecnica della sicurezza.

In caso di uso ed impiego non regolamentari possono insorgere pericoli mortali per l'utilizzatore o per terzi risp. danni all'apparecchio o ad altri beni materiali.

L'apparecchio è destinato solo all'uso regolamentare e va utilizzato solo in uno stato perfetto per quanto riguarda la tecnica della sicurezza.

Eventuali anomalie, che possono pregiudicare la sicurezza devono essere immediatamente eliminate.



## 5 Dati tecnici

Costruttore	Andreas Hettich GmbH & Co. KG D-78532 Tuttlingen			
Modello	ROTIXA 500 RS			
Basic UDI-DI	4050674010002Q2			
Tipo	4950, 4950-50		4950-70, 4950-80	
Tensione di rete ( $\pm 10\%$ )	230-240 V ~	220 V ~	230-240 V ~	220 V ~
Frequenza di rete	50 Hz	60 Hz	50 Hz	60 Hz
Potenza assorbita	3800 VA			
Assorbimento di corrente	16 A			
Tipo di refrigerante	R452A			
Capacità max.	4 x 1000 ml			
Densità permessa	1.2 kg/dm <sup>3</sup>			
Regime di rotazione (RPM)	11500			
Accelerazione (RCF)	18038			
Energia cinetica	59620 Nm			
Obbligo di collaudo (DGUV Regel 100 – 500)	si			
Presupposti ambientali (EN / IEC 61010-1)	<p>solo in interni fino a 2000 metri sopra il livello del mare 5°C fino a 35°C umidità relativa massima dell'aria 80% per temperature fino a 31°C, con riduzione lineare fino al 50% dell'umidità relativa per una temperatura di 40°C.</p>			
– luogo di installazione				
– altezza				
– temperatura ambiente				
– umidità dell'aria				
– Categoria di sovratensione (IEC 60364-4-443)	II			
– grado di imbrattamento	2			
Classe di protezione	I			
non adatto per l'impiego in ambiente a rischio di esplosione.				
Compatibilità elettromagnetica	EN / IEC 61326-1, classe B			
– emissione di radiointerferenze, resistenza alle interferenze				
Livello di emissione acustica (in funzione del rotore)	$\leq 65$ dB(A)		$\leq 63$ dB(A)	
dimensioni				
– larghezza	650 mm			
– profondità	814 mm			
– altezza	973 mm			
Peso	ca. 219 kg		ca. 233 kg	

Costruttore	Andreas Hettich GmbH & Co. KG D-78532 Tuttlingen	
Modello	ROTIXA 500 RS	
Basic UDI-DI	4050674010002Q2	
Tipo	4950-08, 4950-58	4950-78, 4950-88
Tensione di rete ( $\pm 10\%$ )	208 V ~	
Frequenza di rete	60 Hz	
Potenza assorbita	3800 VA	
Assorbimento di corrente	18 A	
Tipo di refrigerante	R452A	
Capacità max.	4 x 1000 ml	
Densità permessa	1.2 kg/dm <sup>3</sup>	
Regime di rotazione (RPM)	11500	
Accelerazione (RCF)	18038	
Energia cinetica	59620 Nm	
Obbligo di collaudo (DGUV Regel 100 – 500)	si	
Presupposti ambientali (EN / IEC 61010-1)	<p>solo in interni fino a 2000 metri sopra il livello del mare 5°C fino a 35°C umidità relativa massima dell'aria 80% per temperature fino a 31°C, con riduzione lineare fino al 50% dell'umidità relativa per una temperatura di 40°C.</p>	
– luogo di installazione		
– altezza		
– temperatura ambiente		
– umidità dell'aria		
– Categoria di sovratensione (IEC 60364-4-443)	II	
– grado di imbrattamento	2	
Classe di protezione	I	
non adatto per l'impiego in ambiente a rischio di esplosione.		
Compatibilità elettromagnetica	FCC Class B	
– emissione di radiointerferenze, resistenza alle interferenze		
Livello di emissione acustica (in funzione del rotore)	$\leq 65$ dB(A)	$\leq 63$ dB(A)
dimensioni		
– larghezza	650 mm	
– profondità	814 mm	
– altezza	973 mm	
Peso	ca. 225 kg	ca. 239 kg

## 6 Indicazioni inerenti la sicurezza



**Se non vengono rispettate tutte le avvertenze riportate in queste istruzioni per il funzionamento, non può essere accettata da parte del costruttore alcuna richiesta di garanzia.**



### **Segnalazione di incidenti gravi con il dispositivo**

In caso di incidenti gravi con il dispositivo, segnalarli al costruttore ed eventualmente alle autorità competenti.



- **La centrifuga deve venire posizionata in modo sicuro.**
- **Prima di utilizzare la centrifuga, è necessario controllare che il rotore sia correttamente in sede.**
- **Durante un'operazione di centrifugazione, in una zona di sicurezza di 300 mm attorno alla centrifuga non deve sostare alcuna persona, materiali pericolosi ed oggetti, in conformità alle norme EN / IEC 61010-2-020.**
- **I rotori, le sospensioni e gli accessori che presentano forti segni di corrosione o danni meccanici, oppure la cui durata d'impiego è scaduta, non devono più essere utilizzati.**
- **Se il vano di centrifugazione presenta danni rilevanti per la sicurezza, la centrifuga non deve essere più messa in funzione.**
- **In rotori oscillanti, i perni di trascinamento devono essere lubrificati regolarmente (Grasso lubrificante Hettich no. d'ord. 4051) per consentire un'oscillazione equilibrata dei ganci.**
- **Nel caso di centrifughe senza regolazione termica, con temperature ambiente elevate e/o con frequente impiego dell'apparecchiatura può presentarsi un riscaldamento del vano di centrifugazione. Per questo motivo non può venire esclusa una modificazione del materiale di prova a causa alla temperatura.**

- **Prima di mettere in funzione la centrifuga si devono leggere ed osservare le istruzioni per l'uso. L'apparecchio può essere utilizzato solo da persone che abbiano letto e compreso le istruzioni d'uso.**
  - Oltre alle istruzioni per l'uso, si devono osservare anche i regolamenti, relativi alla protezione antinfortunistica ed i regolamenti tecnici, riconosciuti in materia di sicurezza del lavoro. Le istruzioni per l'uso vanno completate dalle norme nazionali in vigore nel paese d'impiego, relative alla protezione antinfortunistica ed alla tutela ambientale.
  - La centrifuga è costruita in base all'attuale livello tecnologico e le regole di sicurezza conosciute. La centrifuga può essere tuttavia fonte di pericolo per l'operatore o per terzi, se non viene utilizzata da personale appositamente addestrato o se viene utilizzata in modo improprio o non conforme alla destinazione.
  - Durante l'esercizio bisogna evitare di muovere la centrifuga o di urtarvi contro.
  - In caso di guasto, ovvero del ripristino d'emergenza, non si deve assolutamente toccare il rotore.
  - Quando la centrifuga passa da un ambiente freddo in uno caldo, per evitare danni dovuti alla condensa, lasciar riscaldare la centrifuga per almeno 3 ore nell'ambiente caldo prima di collegarla alla rete, oppure portare la centrifuga a temperatura d'esercizio mettendola in funzione per 30 minuti nell'ambiente freddo.
  - Devono essere utilizzati esclusivamente i rotori e gli accessori omologati per questa apparecchiatura (vedere capitolo "Anhang/Appendix, Rotoren und Zubehör/Rotors and accessories"). Prima di utilizzare contenitori di centrifugazione, che non sono elencati nel capitolo "Appendice/Appendix, Rotori ed accessori/Rotors and accessories", l'utente deve accertarsi presso il costruttore, che questi possano venire utilizzati.
  - Il rotore della centrifuga può essere caricato solo in conformità al capitolo " Carico del rotore".
  - In caso di centrifugazione con massimo numero di giri, la densità dei materiali o delle miscele di materiali non deve superare il valore di composizione di  $1,2 \text{ kg/dm}^3$ .
  - Non è consentito l'uso di centrifughe non bilanciate in modo regolamentare.
  - Non è permesso l'impiego della centrifuga in ambiente a pericolo di esplosione.
  - E' proibito l'uso di una centrifuga con:
    - materiali infiammabili od esplosivi
    - materiali che possono reagire chimicamente tra loro con forte energia.
- Per la centrifugazione di campioni petrolchimici in conformità agli standard ASTM, l'utente deve provvedere all'esecuzione di una valutazione dei rischi.

- Se vengono centrifugate sostanze pericolose o miscele di sostanze contaminate da microrganismi tossici, radioattivi o patogeni, l'utente dovrà prendere opportuni provvedimenti in materia.  
È consentito esclusivamente l'impiego di contenitori di centrifugazione con speciali chiusure a vite per sostanze pericolose. Nel caso di materiali appartenenti al gruppo a rischio 3 e 4 oltre ai contenitori di centrifugazione è da utilizzare un sistema di biosicurezza (vedi manuale "Laboratory Bio-safety Manual" dell'Organizzazione mondiale per la salute).  
Una ermetizzazione biologica (guarnizione ad anello) di questo sistema di biosicurezza impedisce la fuoriuscita delle goccioline e degli aerosol.  
Se il gancio di un sistema di biosicurezza viene utilizzato senza il coperchio, la guarnizione ad anello deve venire tolta dal gancio, per evitare un danneggiamento della guarnizione ad anello durante il processo di centrifugazione. I sistemi di biosicurezza che sono danneggiati non sono più ermetici dal punto di vista microbiologico.  
Senza l'impiego di un sistema di biosicurezza, una centrifuga non può essere considerata a tenuta ermetica dal punto di vista microbiologico ai sensi della norma EN / IEC 61010-2-020.  
Per la chiusura di un sistema di biosicurezza sono da seguire le istruzioni al capitolo "Chiudere i sistemi biologici di sicurezza".  
Per quanto riguarda i sistemi di biosicurezza fornibili, rimandiamo al capitolo "Appendice/Appendix, Rotori ed accessori/Rotors and accessories". Nel dubbio chiedere maggiori informazioni al produttore.
- Non è consentito il funzionamento della centrifuga con sostanze altamente corrosive che possono pregiudicare la resistenza meccanica dei rotor, delle sospensioni e degli accessori.
- Gli interventi di riparazione devono essere effettuati esclusivamente da una persona autorizzata dal costruttore.
- Devono essere impiegati solo ed esclusivamente pezzi di ricambio originali ed accessori autorizzati della ditta Andreas Hettich GmbH & Co. KG.
- Sono di validità le seguenti norme di sicurezza:  
EN / IEC 61010-1 e EN / IEC 61010-2-020 come anche le loro nazionali varianti.
- La sicurezza e l'affidabilità della centrifuga sono garantite solo se:
  - la centrifuga funziona in conformità con le istruzioni per l'uso
  - l'installazione elettrica sul luogo di posizionamento della centrifuga risponde ai requisiti previsti dalla EN / IEC.
- Rientra nelle responsabilità dell'utente il rispetto degli standard specifici nazionali per la sicurezza del lavoro riguardanti l'impiego delle centrifughe di laboratorio ai posti di lavoro da lui previsti.

## 7 Disimballaggio e collocamento della centrifuga

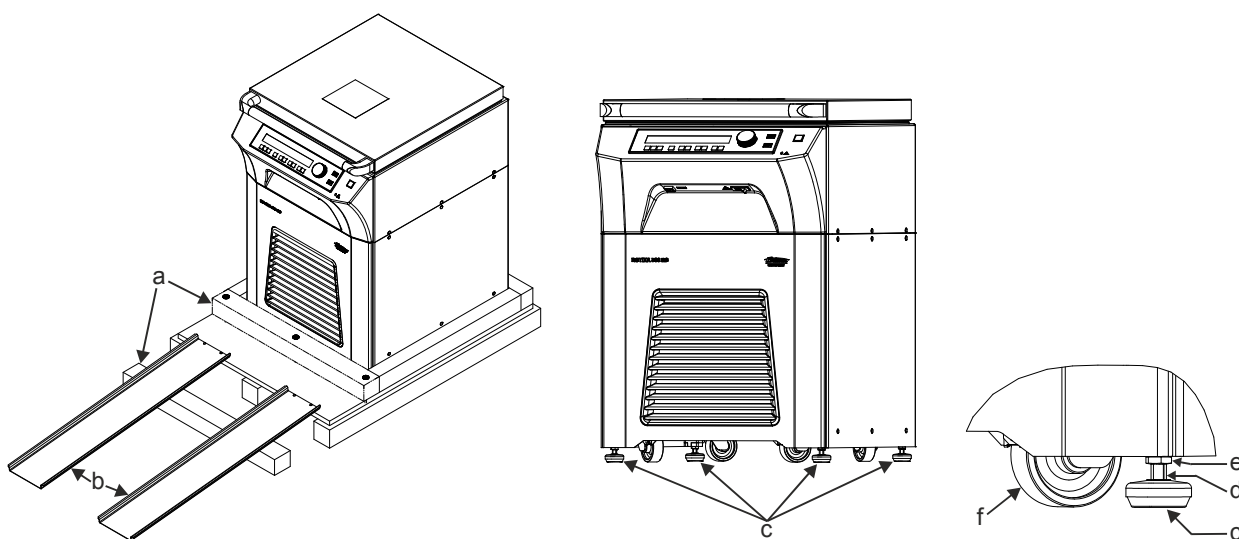

- Rimuovere l'imballaggio.
- Rimuovere le travi di legno (a) anteriori.
- Utilizzando due chiodi per ciascuna, fissare le rotaie di metallo (b) alla paletta di legno.
- Spingere le travi di legno (a) anteriori sotto le rotaie di metallo (b) per poterle supportare.
- Applicare la chiave fissa (da 10 mm), che fa parte della fornitura, ai punti (d) e girare per quanto possibile verso l'alto i piedini dell'apparecchiatura (c).
- Lasciar scendere la centrifuga con cautela dalla paletta di legno, facendola passare con le rotelle sulle rotaie di metallo (b).
- Spingere la centrifuga sul suo luogo di collocamento.
- Applicare la chiave fissa (da 10 mm), che fa parte della fornitura, alle superfici (d) e svitare verso il basso i piedini l'apparecchiatura (c), fino a quando le rotelle di guida (f) non hanno più alcun contatto con il pavimento.
- Girando i piedini dell'apparecchiatura (c) mettere la centrifuga in posizione orizzontale.
- Girare verso l'alto e serrare con forza i dadi esagonali (e) utilizzando la chiave fissa (da 19 mm) che fa parte della fornitura, per assicurare la posizione dei piedini dell'apparecchiatura (c).

## 8 Contenuto della fornitura

- 1 Cavo di rete
- 1 Chiave fissa semplice, da 10 mm (per girare i piedini dell'apparecchiatura)
- 1 Chiave fissa doppia, da 17/19 mm (per serrare con forza i dadi esagonali ai piedini dell'apparecchiatura)
- 1 Chiave a maschio quadro (per montaggio e smontaggio del rotore)
- 1 Chiave a brugola esagonale (per lo sbloccaggio di emergenza del coperchio)
- 1 Grasso per perni portanti
- 1 Svuotatore tubetti
- 10 Cappucci (Ø12 mm) di copertura per teste di vite Torx del tipo T20
- 1 Istruzioni per l'uso
- 3 Schede dati di programma

Rotore/i e i corrispondenti accessori vengono forniti in base alla commessa.

## 9 Trasporto ed immagazzinaggio

### 9.1 Trasporto

Per il trasporto dell'apparecchiatura e degli accessori devono venire rispettati i seguenti presupposti di ambiente.

- Temperatura ambiente: -20°C fino a +60°C
- Umidità relativa dell'aria: 10% fino a 80%, non condensante

### 9.2 Immagazzinaggio



L'immagazzinaggio dell'apparecchiatura e degli accessori è ammesso solo in ambienti chiusi ed asciutti.

Per l'immagazzinaggio dell'apparecchiatura e degli accessori devono essere rispettati i seguenti presupposti di ambiente.

- Temperatura ambiente: -20°C fino a +60°C
- Umidità relativa dell'aria: 10% fino a 80%, non condensante

## 10 Messa in funzione

- Se l'unità è protetta anche da un interruttore differenziale nell'impianto dell'edificio, è necessario utilizzare un interruttore differenziale di tipo B. Se si utilizza un tipo diverso, l'interruttore differenziale potrebbe non spegnere l'unità in caso di guasto, oppure spegnerla anche se non è presente alcun guasto.
- I tipi 4950-08, 4950-58, 4950-78 e 4950-88 sono unità collegate in modo permanente. Per le unità collegate in modo permanente, nell'impianto dell'edificio deve essere installato un interruttore per scollegare l'alimentazione di rete dell'unità, in conformità alla norma sulle apparecchiature di laboratorio EN / IEC 61010-1. L'interruttore deve essere posizionato vicino all'unità, facilmente accessibile all'utente e contrassegnato come dispositivo di disconnessione per questa unità. Deve essere possibile bloccare l'interruttore per evitare che venga reinserito.
- I tipi 4950-70, 4950-78, 4950-80 e 4950-88 possono essere installati solo da personale specializzato e autorizzato.



Questi apparecchi devono essere installati secondo le istruzioni di montaggio e installazione AH4950EN allegate.

- **Porre la centrifuga in un posto adatto e livellarla. Per l'installazione deve essere rispettata la zona di sicurezza di 300 mm attorno alla centrifuga, richiesta in conformità alle norme EN / IEC 61010-2-020.**



**Durante un'operazione di centrifugazione, in una zona di sicurezza di 300 mm attorno alla centrifuga non deve sostare alcuna persona, materiali pericolosi ed oggetti, in conformità alle norme EN / IEC 61010-2-020.**

- Le aperture di ventilazione non devono essere chiuse mettendo oggetti davanti. Rispetto alle feritoie di ventilazione e ad alle aperture di ventilazione della centrifuga deve venir mantenuta una distanza di 300 mm.
- Centrifuga con connettore PA:  
all'occorrenza collegare il connettore PA sul retro dell'apparecchio con un sistema di collegamento equipotenziale medico aggiuntivo.
- Centrifuga con interfaccia ottica:  
collegare l'interfaccia ottica della centrifuga al PC con un cavo a fibre ottiche (non fa parte della fornitura).
- Verificare se la tensione di rete sia adatta all'indicazione riportata nella targhetta con i dati caratteristici.
- Collegare la centrifuga ad una presa di rete standard utilizzando un cavo di rete. Per la potenza massima assorbita, vedere il capitolo "Dati tecnici".
- Accendere l'interruttore di rete. Posizione di accensione "I".  
Compare l'indicazione:  
1. Tipo di centrifuga, 2. il codice rotore rilevato per ultimo dal riconoscimento rotore e il numero di giri massimo del rotore (n-max-rotore), 3. Versione del programma, 4. **OPEN** **OEFFNEN**.
- Aprire il coperchio.  
Vengono illustrati i dati di centrifuga del programma utilizzato per ultimo o del programma 1.

## 11 Interfaccia (solo per la centrifuga con interfaccia)

In opzione, l'apparecchiatura può essere dotata di un'interfaccia ottica.





L'interfaccia ottica è contrassegnata dal simbolo 

Attraverso questa interfaccia si può comandare la centrifuga e richiamare i dati.

## 12 Apertura e chiusura del coperchio



### 12.1 Apertura del coperchio

 E' possibile aprire il coperchio solo se la centrifuga è accesa ed il rotore è fermo. Se non dovesse essere possibile, vedi capitolo "Sblocco di emergenza".

- Premere il tasto  sul pannello anteriore. Il coperchio si sblocca a motore, l'illuminazione del tasto  si spegne e nell'indicazione il simbolo  si trasforma nel simbolo .

### 12.2 Chiusura del coperchio

 Non afferrare con le dita tra il coperchio e il rivestimento. Non chiudere il coperchio sbattendolo.

- Appoggiare il coperchio e spingerlo leggermente in basso mediante la maniglia tubolare. La chiusura avviene grazie ad un sistema motorizzato. Il tasto  si illumina e sul display il simbolo  si modifica nel simbolo .

## 13 Installazione e disinstallazione del rotore

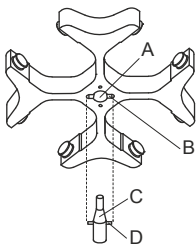

- Pulire l'albero motore (C) ed il foro del rotore (A), successivamente lubrificare leggermente l'albero motore. Particelle di sporco tra l'albero motore ed il rotore impediscono un normale funzionamento del rotore e causano un movimento rumoroso.
- Porre il rotore in senso verticale sull'albero motore. Il meccanismo di trascinamento dell'albero motore (D) deve trovarsi nella scanalatura del rotore (B). Sul rotore è segnato l'allineamento della scanalatura.
- Stringere il dado di registrazione di tensione del rotore con l'aiuto della chiave inclusa nel cartone, ruotandola in senso orario.
- Verificare che il rotore sia fissato.

 Per garantire che il rotore sia fissato stabilmente, il dado del rotore deve venir serrato bene a mano.

- Disinstallare il rotore: svitare il dado di registrazione di tensione, ruotandolo in senso anti-orario fino a che non abbia raggiunto il punto di completo svitamento. Con il punto di svitamento completo, il rotore si può smontare dal cono dell'albero motore. Girare il dado di registrazione di tensione fino a che diventi possibile smontare il rotore dall'albero motore.

## 14 Applicare ed estrarre i ganci dal rotore

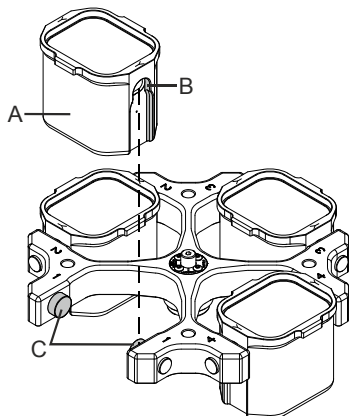

Nel caso di rotori di smorzamento, tutti i posti del rotore devono essere occupati con ganci **uguali**.



Particolari ganci sono contrassegnati con il numero del posto del rotore. L'applicazione di questi ganci è consentita esclusivamente nel corrispondente posto del rotore.

L'applicazione di ganci contrassegnati con un numero di set, p.es. S001/4, è consentita esclusivamente in set.

### Applicare i ganci nel rotore:

- Controllare che il rotore sia fissato stabilmente.
- Ingrassare i perni di supporto (C) (grasso lubrificante Hettich N° 4051).
- Applicare i ganci (A) nel rotore. A questo riguardo prestare attenzione che i perni di supporto (C) si trovino nelle scanalature (B) dei ganci.
- Spingere i ganci verso il basso fino al fermo di arresto.

### Estrarre i ganci dal rotore:

- Estrarre dal rotore, perpendicolarmente verso l'alto, i ganci (A).

## 15 Applicare ed estrarre dai ganci l'adattatore

### Applicare l'adattatore nei ganci:

- Applicare orizzontalmente l'adattatore (A) nei ganci (B).

### Estrarre l'adattatore dai ganci:

- Estrarre verso l'alto l'adattatore (A) dai ganci (B).

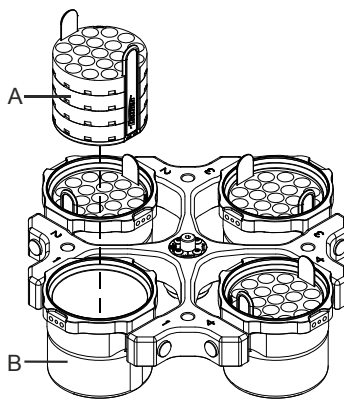
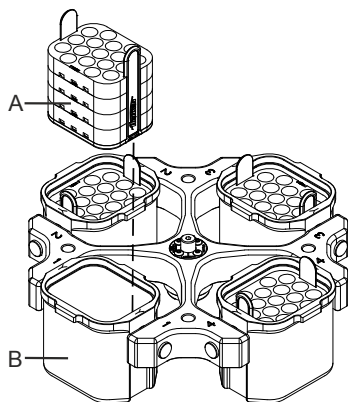



## 16 Carico del rotore



Lo standard dei recipienti di vetro centrifugati sono da caricare fino a RCF 4000 (DIN 58970 capoverso 2).

- Verificare che il rotore sia fissato.
- Nel caso di rotori oscillanti, tutti i siti del rotore devono essere muniti di ganci **uguali**. Particolari ganci sono contrassegnati con il numero del sito del rotore. Questi ganci devono essere applicati solo nel relativo sito del rotore.  
Ganci contrassegnati con un numero di kit, p.es. S001/4, devono essere utilizzati esclusivamente in kit.
- I rotori ed i ganci devono essere caricati esclusivamente in modo simmetrico. I recipienti di centrifuga devono essere distribuiti uniformemente su tutti i posti del rotore. Per le combinazioni permesse vedere capitolo "Anhang/Appendix, Rotoren und Zubehör/Rotors and accessories".  
In caso di rotori angolari devono essere caricati tutti i possibili siti del rotore, vedere il capitolo "Anhang/Appendix, Rotoren und Zubehör/Rotors and accessories".

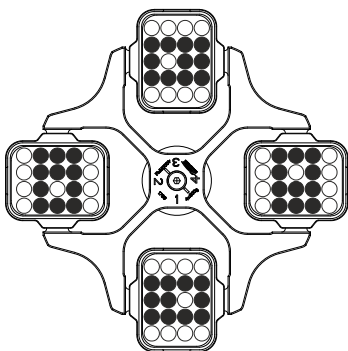

Il rotore è caricato in modo simmetrico

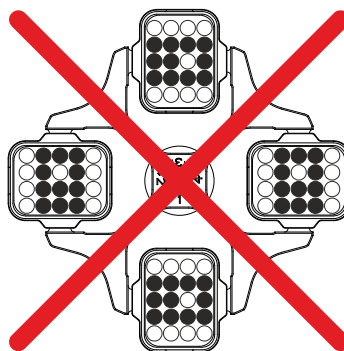

**Non ammesso!**  
Il rotore è caricato in modo non simmetrico

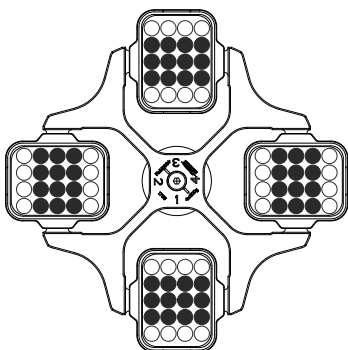

Il rotore è caricato uniformemente

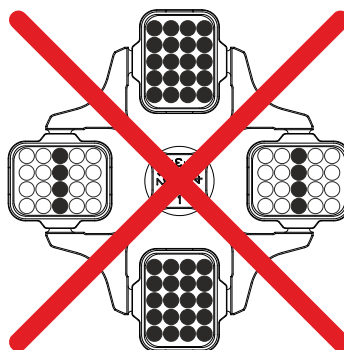

**Non ammesso!**  
Il rotore è caricato in modo non uniforme

- Su certe sospensioni è indicato il peso del carico massimo oppure il peso del carico massimo e il peso massimo della sospensione completamente equipaggiata. Questi pesi non devono essere superati. In casi eccezionali vedere al capitolo "Centrifugazione di sostanze o di miscele di sostanze con densità maggiore di  $1,2 \text{ kg/dm}^3$ ". L'indicazione del peso di carico massimo comprende il peso complessivo dell'adattatore, il contenitore di centrifugazione ed il contenuto.

- Nel caso di contenitori con inserimenti in gomma, deve essere sempre mantenuto lo stesso numero di inserimenti in gomma sotto i contenitori di centrifugazione.
- L'operazione di riempimento dei contenitori di centrifugazione è ammessa solo al di fuori della centrifuga.
- Il carico massimo dei recipienti della centrifuga non deve essere superiore a quello indicato dalla casa costruttrice.

Con rotori a squadra, il riempimento dei contenitori di centrifugazione è consentito solo fino al livello per cui, durante l'operazione di centrifugazione, non venga espulso alcun liquido dai contenitori.

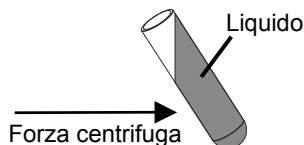

- Con il caricamento di rotori a squadra non deve pervenire alcun liquido nei rotori a squadra e nel vano di centrifugazione.
- Con il caricamento dei ganci dei rotori di smorzamento come anche con lo smorzamento dei ganci durante l'operazione di centrifuga non deve pervenire alcun liquido nei ganci e nel vano di centrifugazione.
- Per limitare al massimo le differenze di peso all'interno dei contenitori di centrifugazione, bisogna fare attenzione che siano riempiti tutti in modo uguale.

## 17 Chiudere i sistemi biologici di sicurezza



Per garantire la tenuta, il coperchio di un sistema biologico di sicurezza deve essere ben chiuso.

Per evitare che durante l'apertura e la chiusura del coperchio l'anello di guarnizione si giri, spalmarvi, frizionando leggermente, una sostanza per la cura della gomma.

Per quanto riguarda i sistemi biologici di sicurezza fornibili, rimandiamo al capitolo "Anhang/Appendix, Rotoren und Zubehör/Rotors and accessories". Nel dubbio chiedere maggiori informazioni al produttore o importatore.

### Coperchio con chiusura a vite e foro nella manopola

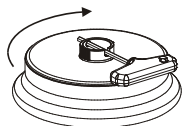

- Applicare il coperchio centralmente sul rotore.
- Inserire la chiave fornita attraverso il foro nella manopola e stringere ruotando il coperchio in senso orario.

### Coperchio con chiusura a vite

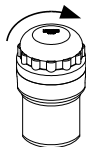

- Applicare il coperchio sul gancio.
- Chiudere con forza a mano il coperchio, girando in senso orario.

## 18 Istruzioni HettLiner per imballaggio

### 18.1 Imballaggio prima della centrifugazione

Avviso: Fate attenzione, che nell'operazione di carico e scarico degli inserti l'inserto in plastica non possa ribaltare (utilizzare l'ausilio di caricamento 4509).

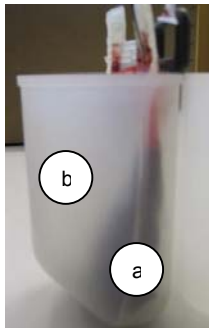
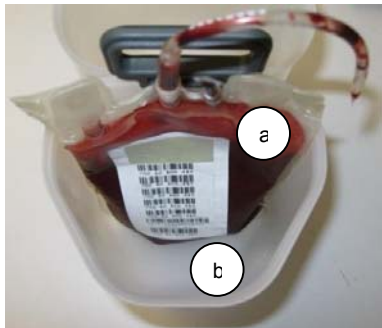

- Applicare la sacca per il plasma (a) nell'inserto (b).

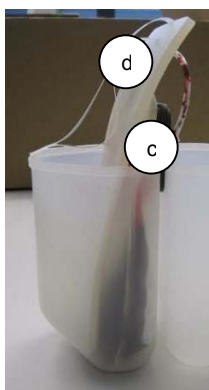
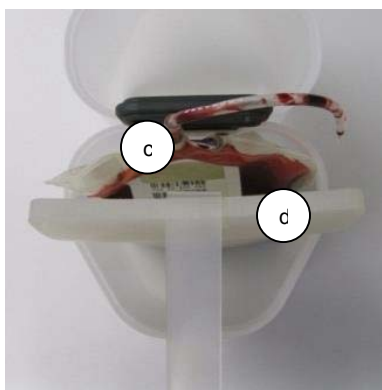

- Trattenere la sacca per il plasma agli attacchi (c) ed al lato esterno della sacca per il plasma spingere nell'inserto dall'alto verso il basso la placca di supporto (d).

- Prestare attenzione che il bordo inferiore della placca di supporto stia il più possibile in modo completo sul fondo.

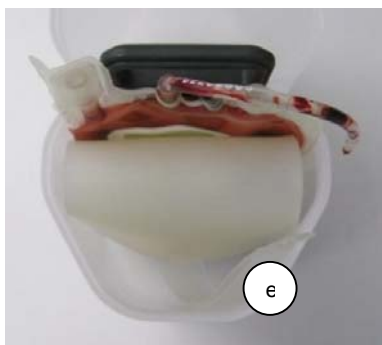

- Piegare la placca di supporto verso l'esterno e quel tanto verso il basso fino a quando il bordo piegato della placca si trova all'altezza del livello del liquido della sacca per il plasma.

- A questo riguardo prestare attenzione alla posizione del laccio (e), in modo che dopo la centrifugazione questi possa venir raggiunto!

- A causa del pericolo di schiacciamento con i bracci del rotore durante la centrifugazione, il bordo superiore della placca di supporto non deve sporgere troppo dall'inserto!

- Se a disposizione, ripiegare le sacche satelliti vuote ed imballare in modo differenziato in funzione del rispettivo accessorio e dei volumi di riempimento della sacca per il plasma.  
È di vantaggio ripiegare le sacche satelliti e di imballarle all'esterno tra la placca di supporto piegata e la parete esterna dell'inserto.  
→ Fare attenzione, che nell'operazione la placca di silicone non scivoli!  
→ Eventualmente, nell'operazione di imballaggio della sacca satellite la placca di silicone può venir trattenuta al laccio ed in questo modo venir sostenuta.  
→ La posizione del laccio deve venir poi controllata!
- Adagiare gli attacchi sopra la placca di supporto in modo che le valvole non possano rompersi. Fare attenzione che i tubi flessibili non sporgano dall'inserto!

→ Sistemare tra le placche di supporto piegate e la parete dell'inserto le parti dei tubi flessibili che sporgono oltre il bordo dell'inserto.

- I pesi di equilibratura dovrebbero venir posti, se sono necessari, tra la placca di supporto piegata e la parete del bicchiere.

## **18.2 Disimballare dopo la centrifugazione**

- Estrarre dall'inserto la sacca satellite e facendo ciò fissare con una mano la placca di silicone.
- Estrarre lentamente la parte piegata della placca di supporto tenendola all'apposito laccio!  
→ Attenzione: La placca di supporto è da ridisporre controllatamene nella sua forma originale!  
→ La parte piegata della placca di supporto può rimbalzare indietro e così facendo può miscelare componenti del sangue.
- La rimanente sacca per il plasma è da prelevare a scelta insieme con la placca di supporto oppure dopo aver rimosso la placca di supporto!

## 19 Elementi di comando e visualizzazione

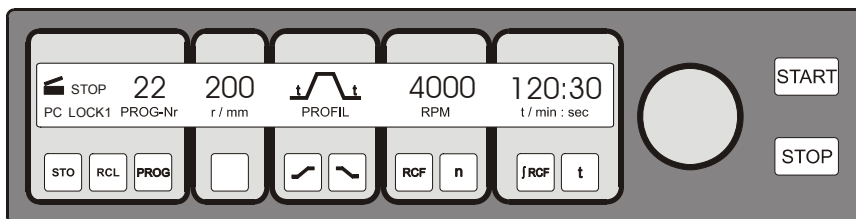

### 19.1 Indicatori di stato



Coperchio aperto



Coperchio chiuso.



Indicazione della centrifugazione. L'indicazione avviene durante il ciclo di centrifugazione, per quanto giri il rotore.

**STOP**

Ciclo di centrifugazione interrotto o terminato. Indicazione al termine del ciclo di centrifugazione, per quanto giri il rotore. L'indicatore lampeggia dopo un arresto d'emergenza.

**LOCK 1,  
LOCK 2**

Posizione di commutazione dell'interruttore a chiave.

**LOCK 4,  
LOCK 5**

Blocco del programma con comunicazione seriale (solo nelle centrifughe con comunicazione seriale).

**PC, PE**

Comunicazione seriale (solo nelle centrifughe con comunicazione seriale).

Errori di comando ovv. anomalie che si presentano vengono visualizzati nel display (vedi capitolo "Guasti").

### 19.2 Manopola



Per l'impostazione dei singoli parametri.

La rotazione in senso antiorario riduce il valore. La rotazione in senso orario aumenta il valore.

### 19.3 Tasti e possibilità di regolazione



Tempo ciclo, parametro t/min:sec

1. Parametro t/min: Impostabile da 1 - 999 min., ad intervalli di 1 min.
2. Parametro t/:sec Impostabile da 1 - 59 sec., ad intervalli di 1 secondo.
3. Funzionamento continuo "---:--"



Interrogazione dell'integrale RCF, parametro fRCF.



1. Numero di giri, parametro RPM

È impostabile un valore numerico di 50 rpm fino al numero di giri massimo del rotore (n-max-Rotor). Per il numero di giri massimo del rotore, vedi capitolo "Anhang/Appendix, Rotoren und Zubehör/Rotors and accessories". Regolabile ad intervalli di 10.

2. Interrogazione del numero di giri massimo del rotore, parametro n-max-Rotor.



1. Accelerazione centrifuga relativa, parametro RCF/RZB

È impostabile un valore numerico con il quale si ottiene un numero di giri compreso tra 50 rpm ed il numero di giri massimo del rotore (n-max-rotore). Regolabile ad intervalli di 1.

2. Interrogazione del RCF massimo del rotore, parametro RCF-max-Rotor.



Parametri di avviamento

1. Livelli di avviamento, parametri  $\curvearrowright_{1-9}$ . Livello 9 = tempo di avviamento più breve, ... Livello 1 = tempo di avviamento più lungo.

2. Tempo di avviamento, parametri  $\curvearrowright_{\text{min:sec}}$ . Il campo di durata regolabile dipende dal numero di giri impostato.



Parametri di arresto

1. Livelli di rallentamento, parametri  $\curvearrowleft_{0-9}$ . R = curva di frenatura lineare, B = simile ad una curva di frenatura esponenziale. Livello R9, B9 = tempo di arresto breve, ... Livello R1, B1 = tempo di arresto lungo, livello R0 = arresto graduale senza frenatura.

2. Tempo di arresto, parametri  $\curvearrowleft_{\text{min:sec}}$ . Il campo di durata regolabile dipende dal numero di giri impostato.

3. Numero di giri per la disattivazione frenatura, parametro  $n^{(c)}/\text{RPM}$

Al raggiungimento di questo numero di giri si ha un arresto graduale senza frenatura.

1. Valore nominale temperatura, parametro T/°C. Regolabile da -20°C a +40°C, ad intervalli di 1°C (regolabile con opzione di riscaldamento/ raffreddamento da -20 °C a +60°C. La più bassa temperatura raggiunta dipende dal rotore (vedi capitolo "Anhang/Appendix, Rotoren und Zubehör/Rotors and accessories").
2. Raggio di centrifugazione, parametro r/mm. Immissione in mm. Per il raggio di centrifugazione, vedi capitolo "Anhang/Appendix, Rotoren und Zubehör/Rotors and accessories".

START

1. Avviare il ciclo di centrifugazione. Si attiva l'indicazione della centrifugazione .
2. Adozione di modifiche durante il ciclo di centrifugazione.

STOP

Terminare il ciclo di centrifugazione.  
Il rotore si arresta gradualmente con il parametro di arresto prestabilito. Una doppia pressione del tasto fa scattare l'arresto di emergenza.

PROG

Selezionare la posizione di programma, parametro PROG-Nr.

RCL

Richiamo di programmi.

STO

Memorizzazione di programmi.  
Possono essere memorizzati 89 programmi (posizioni di programma da 1 a 89). Nota: Le posizioni di programma "----" e 90 fino a 99 servono come memoria temporanea automatica (vedi capitolo "Memoria temporanea automatica"). In queste posizioni programma non possono essere memorizzati programmi.



## 20 Immettere i parametri di centrifugazione



L'immissione di un parametro è solo possibile se il campo d'immissione viene visualizzato in modo invertito (con sfondo scuro). Un campo d'immissione invertito si spegne automaticamente dopo 10 secondi.

### 20.1 Tempo ciclo



#### 20.1.1 Preselezione del tempo

- Premere ripetutamente il tasto  fino a che viene visualizzato il parametro t/min: o t/ :sec. Il campo d'immissione viene visualizzato in modo invertito.
- Con la manopola  impostare il valore voluto.



#### 20.1.2 Funzionamento continuo

- Selezionare uno dopo l'altro i parametri t/min: e t/ :sec (vedi capitolo "Preselezione del tempo"), e regolarli entrambi su zero tramite la manopola .
- Nel campo d'immissione viene visualizzato "---:--".

### 20.2 Numero di giri (RPM)

- Premere ripetutamente il tasto  fino a che viene visualizzato il parametro RPM e il campo d'immissione appare in modo invertito.
- Con la manopola  impostare il valore voluto.

### 20.3 Accelerazione centrifuga relativa (RCF/RZB)

- Premere ripetutamente il tasto  fino a che viene visualizzato il parametro RCF/RZB ed il campo d'immissione appare in modo invertito.
- Con la manopola  impostare il valore voluto.

Durante la regolazione lampeggia l'indicatore del raggio di centrifugazione.

### 20.4 Parametri di avviamento e arresto





Vengono visualizzati i parametri di avviamento e di arresto impostati.





x: 1-9 = livello di avviamento, t = tempo di avviamento

y: R1-R9, B1-B9 = livello di frenatura, R0 = arresto graduale senza frenatura, t = tempo di arresto, n<sup>(\*)</sup> = numero di giri per la disattivazione frenatura

#### 20.4.1 Livello di avviamento



- Premere ripetutamente il tasto  fino a che viene visualizzato il parametro <sub>1-9</sub> oppure . Il campo d'immissione viene visualizzato in modo invertito.
- Con la manopola  impostare il livello voluto.

### 20.4.2 Tempo di avviamento

- Premere ripetutamente il tasto  fino a che viene visualizzato il parametro  $t_{\text{min:sec}}$ . Il campo d'immissione viene visualizzato in modo invertito.
- Con la manopola  impostare il valore voluto.

Se viene impostato un tempo di avviamento che è più lungo del tempo ciclo, il ciclo di centrifugazione termina prima di aver raggiunto il numero di giri impostato.



### 20.4.3 Livello di frenatura

- Premere ripetutamente il tasto  fino a che viene visualizzato il parametro  $f_{0-9}$  oppure  $f$ . Il campo d'immissione viene visualizzato in modo invertito.
- Con la manopola  impostare il livello voluto.



Livelli di rallentamento B possono essere impostati solo con rotori speciali.

### 20.4.4 Tempo di arresto

Se è impostato un numero di giri per la disattivazione frenatura, non è impostabile alcun tempo di arresto.



- Premere ripetutamente il tasto  fino a che viene visualizzato il parametro  $t_{\text{min:sec}}$ . Il campo d'immissione viene visualizzato in modo invertito.
- Con la manopola  impostare il valore voluto.

### 20.4.5 Numero di giri per la disattivazione frenatura

- Premere ripetutamente il tasto  fino a che viene visualizzato il parametro  $n^{(*)}/\text{RPM}$ . Il campo d'immissione viene visualizzato in modo invertito.
- Con la manopola  impostare il valore voluto.



## 20.5 Raggio/Temperatura

### 20.5.1 Raggio

- Premere ripetutamente il tasto  fino a che viene visualizzato il parametro  $r/\text{mm}$  ed il campo d'immissione appare in modo invertito.
- Con la manopola  impostare il valore voluto.

Modificando il raggio, il valore del RCF/RZB viene adattato automaticamente, il che viene visualizzato tramite il lampeggiamento.

### 20.5.2 Temperatura





- Premere ripetutamente il tasto  fino a che viene visualizzato il parametro  $T/^{\circ}\text{C}$  ed il campo d'immissione appare in modo invertito.
- Con la manopola  impostare il valore voluto.

## 20.6 Memoria temporanea automatica

La memoria temporanea comprende le posizioni programma "----" e 90 a 99. Dopo ogni avvio di un ciclo di centrifugazione, i dati di centrifugazione modificati vengono memorizzati automaticamente nella posizione di programma "----". Di dati di centrifugazione modificati degli ultimi 11 cicli di centrifugazione sono memorizzati nella memoria temporanea e possono essere richiamati (vedi capitolo "Richiamo del programma").

## 21 Programmazione

### 21.1 Impostazione/modifica del programma

- Impostare i parametri voluti (vedi capitolo "Immettere i parametri di centrifugazione").
- Premere il tasto  per selezionare il parametro PROG-Nr. Il campo d'immissione viene visualizzato in modo invertito.
- Con la manopola  impostare la posizione di programma voluta.  
Se l'indicatore della posizione di programma lampeggia, questa posizione di programma è già occupata da dati di centrifugazione. In questo caso è necessario impostare una posizione di programma libera oppure sovrascrivere i dati di centrifugazione con Continua.
- Premere 1x il tasto  per memorizzare le impostazioni sulla posizione di programma voluta.  
Premere 2x il tasto  per sovrascrivere dati di centrifugazione già salvati.

## 21.2 Richiamo del programma

- Premere il tasto **[PROG]** per selezionare il parametro PROG-Nr. Il campo d'immissione viene visualizzato in modo invertito.
- Con la manopola **○** impostare la posizione di programma voluta.
- Premere il tasto **[RCL]**. Vengono visualizzati i dati di centrifugazione della posizione di programma selezionata.

## 22 Centrifugazione



Durante un'operazione di centrifugazione, in una zona di sicurezza di 300 mm attorno alla centrifuga non deve sostare alcuna persona, materiali pericolosi ed oggetti, in conformità alle norme EN / IEC 61010-2-020.



Nel caso in cui la differenza di peso permessa nel caricamento del rotore venga superata, si ferma l'azionamento durante l'avvio, e compare la dicitura **IMBALANCE / UNWUCHT**.

Se il numero di giri nel programma selezionato è più elevato del numero di giri massimo del rotore (n-max-rotore), non è possibile avviare un ciclo di centrifugazione. Viene visualizzato **N > ROTOR MAX 96** (vedi capitolo "Guasti").

Una corsa di centrifugazione può essere interrotta in ogni momento premendo il tasto **[STOP]**

Con i tasti **[n]** e **[RCF]** è possibile passare in ogni momento dalla visualizzazione RPM a quella RCF e viceversa. Se si lavora con la visualizzazione RCF, è necessario immettere il raggio di centrifugazione.

Se compaiono le diciture **◀ OPEN ▶ OEFFNEN (=APRIRE)**, è possibile un'operazione della centrifuga solo dopo aver aperto una volta il coperchio.

Se viene visualizzato **R xx n-max xxxxx**, non ha avuto luogo alcun processo di centrifugazione in quanto è stato sostituito il rotore, vedere il capitolo "Riconoscimento del rotore".

- Accendere l'interruttore di rete. Posizione dell'interruttore I.
- Caricare il rotore e chiudere il coperchio della centrifuga.

### 22.1 Centrifugazione con preselezione del tempo

- Impostare il tempo o richiamare un programma con preselezione del tempo (vedi capitolo "Immettere i parametri di centrifugazione" o "Richiamo del programma").
- Premere il tasto **[START]**. L'indicazione della centrifugazione **⦿** rimane attiva finché gira il rotore.
- Una volta scaduto il tempo o in caso di interruzione del ciclo di centrifugazione premendo il tasto **[STOP]**, si ha un arresto graduale con il parametro di arresto selezionato. Dopo il fermo completo del rotore, il simbolo **☐** nel visualizzatore continua a lampeggiare fino a che viene aperto il coperchio.

Durante lo svolgimento della centrifugazione vengono esposti il regime di rotazione del rotore oppure il valore RCF, la temperatura nel vano di centrifugazione ed il tempo residuo.

### 22.2 Funzionamento continuo

- Impostare il simbolo **---:-- einstellen** o richiamare un programma di funzionamento continuo (vedi capitolo "Immettere i parametri di centrifugazione" o "Richiamo del programma").
- Premere il tasto **[START]**. L'indicazione della centrifugazione **⦿** rimane attiva finché gira il rotore. Il conteggio del tempo parte da 00:00.
- Premere il tasto **[STOP]** per terminare il ciclo di centrifugazione. L'arresto avviene con il parametro di arresto selezionato. Dopo il fermo completo del rotore, il simbolo **☐** nel visualizzatore continua a lampeggiare fino a che viene aperto il coperchio.

Durante lo svolgimento della centrifugazione vengono esposti il regime di rotazione del rotore oppure il valore RCF, la temperatura nel vano di centrifugazione ed il tempo decorso.

## 23 Modifica delle impostazioni durante il ciclo di centrifugazione

Il tempo ciclo, il numero di giri, l'accelerazione centrifuga relativa (RCF/RZB), i parametri di avviamento e di arresto nonché la temperatura possono essere modificate durante il ciclo di centrifugazione.

I parametri possono essere modificati solo ad uno ad uno e uno dopo l'altro.

- Selezionare il parametro voluto e modificare il valore con la manopola **○** (vedi capitolo "Immettere i parametri di centrifugazione").
- Premere il tasto **[START]**. L'impostazione modificata viene memorizzata sulla posizione di programma "----" (vedi capitolo "Memoria temporanea automatica"). Il programma originale non viene sovrascritto.



## 24 Integrale RCF ( $\int RCF$ )

L'integrale RCF ( $\int RCF$ ) è una misura per l'effetto di sedimentazione ( $\int n^2 dt$ ). Questo valore numerico serve per confrontare cicli di centrifugazione. Per l'interrogazione dell'integrale RCF, mantenere premuto il tasto  $\int RCF$ .

## 25 Visualizzazione del numero dei giri massimo del rotore

- Premere ripetutamente il tasto  $\int$  fino a che viene visualizzato il parametro RPM ed il campo d'immissione appare in modo invertito.
- Premere ancora 1x il tasto  $\int$  e tenerlo premuto, viene visualizzato il numero di giri massimo del rotore (n-max-Rotor).

## 26 Visualizzazione del RCF massimo del rotore

- Premere ripetutamente il tasto  $\int RCF$  fino a che viene visualizzato il parametro RCF/RZB ed il campo d'immissione appare in modo invertito.
- Premere ancora 1x il tasto  $\int RCF$  e tenerlo premuto, viene visualizzato il RCF massimo del rotore (RCF-max-Rotor).

## 27 Arresto di emergenza

- Premere 2x il tasto  $\int STOP$ . Nel visualizzatore lampeggia il simbolo **STOP**.

Nell'arresto di emergenza l'arresto avviene con il livello di frenatura R9 (tempo di arresto più breve). Se era stato prelezionato il livello di frenatura R0, per ragioni tecniche il tempo di arresto è più lungo che con il livello di frenatura R9.

## 28 Segnale acustico

Il segnale acustico risuona dopo la seguente impostazione:

<b>OFF</b>	<ul style="list-style-type: none"> <li>• all'insorgere di un'anomalia nell'intervallo di 2 sec.</li> </ul>
<b>ON1</b>	<ul style="list-style-type: none"> <li>• all'insorgere di un'anomalia nell'intervallo di 2 sec.</li> <li>• al termine del ciclo di centrifugazione e con il fermo completo del rotore nell'intervallo di 30 sec.</li> </ul>
<b>ON2</b>	<ul style="list-style-type: none"> <li>• all'insorgere di un'anomalia nell'intervallo di 2 sec.</li> <li>• al termine del ciclo di centrifugazione e con il fermo completo del rotore nell'intervallo di 30 sec.</li> <li>• ad ogni pressione di un tasto.</li> </ul>

Il segnale acustico termina aprendo il coperchio o premendo un tasto qualsiasi.

A rotore fermo, il segnale può essere regolato nel modo seguente:

- Aprire il coperchio.
- Tenere premuto il tasto  $\int$  per 8 secondi.  
Dopo 8 secondi viene visualizzato **SOUND / BELL XXX**.
- Con la manopola  $\odot$ , impostare la funzione voluta (OFF, ON1, ON2).
- Premere il tasto  $\int START$  per memorizzare l'impostazione.  
In segno di conferma viene brevemente visualizzato **\*\*\* ok \*\*\***.

## 29 Interrogazione delle ore di esercizio

L'interrogazione delle ore di esercizio è possibile solo a rotore fermo.

- Aprire il coperchio.
- Tenere premuto il tasto  $\int$  per 8 secondi.  
Dopo 8 secondi viene visualizzato **SOUND / BELL XXX**.
- Premere ancora 1x il tasto  $\int$ .  
Vengono visualizzate le ore di esercizio (**CONTROL:** ) della centrifuga.  
La visualizzazione delle ore di esercizio si spegne automaticamente dopo 10 secondi.

### 30 Impostazione della data e dell'ora

L'impostazione della data e dell'ora è solo possibile a rotore fermo.

- Aprire il coperchio.
- Tenere premuto il tasto **[T]** per 8 secondi.  
Dopo 8 secondi viene visualizzato **SOUND / BELL XXX**.
- Premere ancora 2x il tasto **[T]**.  
Vengono visualizzati la data e l'ora (a: anno, mon: mese, d: giorno, h: ore, min: minuti).
- Premere ripetutamente il tasto **[ ]** fino a che il campo d'immissione del parametro voluto viene indicato in modo invertito.
- Con la manopola **[O]** impostare il valore voluto.
- Premere il tasto **[START]** per memorizzare l'impostazione.  
In segno di conferma viene brevemente visualizzato **\*\*\* ok \*\*\***.
- Per uscire dall'impostazione della data e dell'ora, premere un tasto qualsiasi all'infuori i tasti **[ ]**, **[T]** ed **[START]**.

### 31 Dati di centrifugazione visualizzati dopo l'accensione

Dopo l'accensione vengono visualizzati i dati di centrifugazione del programma 1 oppure quelli dell'ultimo programma utilizzato. Ciò può essere impostato come segue:

- Aprire il coperchio.
- Spegner e riaccendere l'interruttore di rete. Posizione dell'interruttore **I**.
- Alla prima modifica visiva nel visualizzatore (visualizzazione invertita), premere il tasto **[STOP]**.  
Viene visualizzato **PROGRAM 1, LAST PROGRAM**.
- Con la manopola **[O]**, impostare la funzione voluta.
- Premere il tasto **[START]** per memorizzare l'impostazione.  
In segno di conferma viene brevemente visualizzato **\*\*\* ok \*\*\***.

### 32 Visualizzazione immediata dei dati di centrifugazione dopo l'accensione

- Accendere l'interruttore di rete. Posizione dell'interruttore **I**.
- Alla prima modifica visiva nel visualizzatore (visualizzazione invertita), premere un tasto qualsiasi all'infuori del tasto **[STOP]**. I dati di centrifugazione vengono visualizzati immediatamente.

### 33 Interruttore a chiave

Con l'interruttore a chiave possono essere impostati i seguenti blocchi del programma:

Posizione con chiave a sinistra:	Viene visualizzato <b>LOCK 1</b> . I programmi possono essere solo richiamati, non modificati.
Posizione con chiave a destra:	Viene visualizzato <b>LOCK 2</b> . I programmi non possono essere né richiamati né modificati.
Posizione con chiave in mezzo:	nessuna indicazione di stato. Nessun blocco del programma. I programmi possono essere richiamati e modificati.

### 34 Collegamento di programma (solo nelle centrifughe con collegamento di programma)

Grazie al collegamento di programma è possibile collegare più cicli di centrifugazione.

#### 34.1 Collegare i programmi



Un collegamento di programma è solo possibile con programmi nei quali sono impostati i livelli di avvio e di frenatura.

Prima del collegamento è necessario che i programmi vengano memorizzati nella successione voluta tramite l'impostazione del programma oppure tramite il richiamo del programma (vedi capitolo "Programmazione").

Le posizioni programma devono trovarsi in successione diretta (ad es. posizioni programma 10+11+12).

1. Premere il tasto **PROG** per selezionare il parametro PROG-Nr. Il campo d'immissione viene visualizzato in modo invertito.
2. Tramite la manopola **○**, impostare la posizione di programma del programma iniziale (XX+).
3. Premere il tasto **RCL**. Vengono visualizzati i dati di centrifugazione della posizione di programma selezionata.
4. Premere 2x il tasto **PROG** per selezionare il parametro PR-PART. Il campo d'immissione viene visualizzato in modo inverso.
5. Premere 2x il tasto **STO**. Il programma viene collegato e viene visualizzato il numero di programma della posizione di programma successiva (+XX+).
6. Premere 2x il tasto **RCL**. Vengono visualizzati i dati di centrifugazione della posizione di programma selezionata.
7. Premere 2x il tasto **STO**. Il programma viene collegato e viene visualizzato il numero di programma della posizione di programma successiva (+XX+).
8. Ripetere i passi 6 e 7 fino a che tutti i programmi sono collegati.
9. Per terminare, premere il tasto **PROG**. Viene visualizzato il numero di programma del programma finale (+XX).

#### 34.2 Modifica del collegamento di programma

- Richiamare il programma voluto (vedi capitolo "Richiamo del programma"), modificare i parametri voluti (vedi capitolo "Immettere i parametri di centrifugazione") e memorizzare nuovamente i dati di centrifugazione sulla stessa posizione di programma (vedi capitolo "Impostazione/modifica del programma"). La memorizzazione elimina il collegamento di programma.
- Ricollegare i programmi (vedi capitolo "Collegare i programmi").

#### 34.3 Ciclo di centrifugazione con collegamento di programma

- Premere 2x il tasto **PROG** per selezionare il parametro PR-PART. Il campo d'immissione viene visualizzato in modo invertito.
- Tramite la manopola **○**, impostare la posizione di programma del programma iniziale (XX+).
- Premere il tasto **RCL**. Vengono visualizzati i dati di centrifugazione della posizione di programma selezionata.
- Premere il tasto **START**. L'indicazione della centrifugazione **⦿** rimane attiva finché gira il rotore. Vengono visualizzati i livelli di avvio e di frenatura del collegamento di programma:



Programma iniziale (XX+)  
x: Livello di avviamento del programma iniziale



Programma successivo (+XX+)  
x: Livello di avviamento del programma successivo



Programma finale (+XX)  
x: Livello di avviamento del programma finale  
y: Livello di frenatura del programma finale

- Una volta scaduto il tempo nel programma finale si ha un arresto graduale con il livello di frenatura del programma finale. In caso di interruzione del ciclo di centrifugazione tramite pressione del tasto **STOP**, si ha un arresto graduale con il livello di frenatura del programma al momento in corso.

#### 34.4 Cancellazione del collegamento di programma

- Premere il tasto **PROG** per visualizzare il parametro PROG-Nr. Il campo d'immissione viene visualizzato in modo invertito.
- Tramite la manopola **○**, impostare la posizione di programma del programma iniziale (XX+).
- Premere il tasto **RCL**. Vengono visualizzati i dati di centrifugazione della posizione di programma selezionata.
- Premere 2x il tasto **PROG** per visualizzare il parametro PR-PART. Il campo d'immissione viene visualizzato in modo invertito.
- Premere 2x il tasto **STO**.
- Premere il tasto **PROG**.

### 35 Raffreddamento

Il valore nominale di temperatura può essere selezionata da -20°C fino a +40°C. Nelle centrifughe con l'opzione di riscaldamento/ raffreddamento, il valore nominale della temperatura è regolabile da -20 °C a +60 °C. La temperatura minima raggiungibile dipende dal rotore (vedere capitolo "Anhang/Appendix, Rotoren und Zubehör/Rotors and accessories"). Se la differenza tra la temperatura Nominale e quella Reale è superiore a 5°C, lampeggia l'indicazione temperatura.

#### 35.1 Raffreddamento-Standby

Con l'arresto del rotore e coperchio chiuso, la camera di centrifugazione viene raffreddata alla temperatura selezionata. Nel display compare il valore nominale di temperatura.

#### 35.2 Pre-raffreddamento del rotore

Per una rapida preraffreddazione del rotore non carico e degli accessori è consigliabile effettuare un ciclo di centrifugazione con le impostazioni funzionamento continuo ed un numero di giri all'incirca del 20% del numero di giri massimo del rotore.

### 36 Riscaldamento

Durante il processo di centrifuga, in caso di necessità, il vano di centrifugazione può essere riscaldato alla temperatura preimpostata.

Al fermo del rotore, il riscaldamento è spento.



Pericolo di combustione! La temperatura superficiale dell'elemento riscaldante nella camera di centrifugazione della centrifuga può raggiungere 500°C / 932°F. Non toccare l'elemento riscaldante.

### 37 Accelerazione centrifuga relativa (RCF)

L'accelerazione centrifuga relativa (RCF) è indicata come un multiplo dell'accelerazione terrestre (g). È un valore numerico privo di unità e funge per paragonare le prestazioni di separazione de sedimentazione.

Il calcolo viene eseguito in base alla formula:

$$RCF = \left( \frac{RPM}{1000} \right)^2 \times r \times 1,118 \quad \Rightarrow \quad RPM = \sqrt{\frac{RCF}{r \times 1,118}} \times 1000$$

RCF = accelerazione centrifuga relativa

RPM = numero dei giri

r = raggio di centrifugazione in mm = distanza dal centro dell'asse di rotazione fino al fondo del recipiente di centrifugazione. Raggio di centrifugazione vedi al capitolo "Anhang/Appendix, Rotoren und Zubehör/Rotors and accessories".



L'accelerazione centrifuga relativa (RCF) dipende dal numero dei giri e dal raggio di centrifugazione.

### 38 Centrifugazione di sostanze o di miscele di sostanze con densità maggiore di 1,2 kg/dm<sup>3</sup>

In caso di centrifugazione con massimo numero di giri, la densità dei materiali o delle miscele di materiali non deve superare il valore di composizione di 1,2 kg/dm<sup>3</sup>.

Con sostanze o miscele di sostanze di densità maggiore, il regime di rotazione deve venire ridotto.

Il numero di giri consentito si calcola con la formula seguente:

$$\text{numero di giri ridotto (n}_{\text{red}}) = \sqrt{\frac{1,2}{\text{densità maggiore [kg/dm}^3]}} \times \text{regime massimo di rotazione [RPM]}$$

p.es.: regime massimo di rotazione RPM 4000, densità 1,6 kg/dm<sup>3</sup>

$$n_{\text{red}} = \sqrt{\frac{1,2 \text{ kg/dm}^3}{1,6 \text{ kg/dm}^3}} \times 4000 \text{ RPM} = 3464 \text{ RPM}$$

Se in casi eccezionali viene superato il carico massimo indicato sul gancio, il regime di rotazione deve essere ridotto.

Il numero di giri consentito si calcola con la formula seguente:

$$\text{numero di giri ridotto (n}_{\text{red}}) = \sqrt{\frac{\text{carico massimo [g]}}{\text{carico effettivo [g]}}} \times \text{regime massimo di rotazione [RPM]}$$

p.es.: regime massimo di rotazione RPM 4000, carico massimo 350 g, carico effettivo 300 g

$$n_{\text{red}} = \sqrt{\frac{300 \text{ g}}{350 \text{ g}}} \times 4000 \text{ RPM} = 3703 \text{ RPM}$$

In caso di dubbio, rivolgersi al costruttore per maggiori informazioni.

### 39 Riconoscimento del rotore

Con l'inizio di ogni corsa di centrifugazione avviene il riconoscimento del rotore installato.

Dopo una sostituzione del rotore, il ciclo di centrifugazione si interrompe dopo il riconoscimento del rotore. Vengono visualizzati il Rotorcode (R xx) e il numero di giri massimo (n-max=xxxxx) del rotore.



L'ulteriore utilizzo della centrifuga è possibile solo dopo avere aperto una volta il coperchio.

Se il numero di giri massimo del rotore utilizzato è inferiore al numero di giri impostato, la velocità viene limitata al numero di giri massimo del rotore.

### 40 Sblocco di emergenza

In caso di una caduta di tensione, il coperchio non può essere sbloccato a motore. Deve essere effettuata manualmente uno sblocco di emergenza.



Per lo sblocco di emergenza, disconnettere la centrifuga dalla rete elettrica. Negli apparecchi a collegamento fisso, disinserire l'interruttore di rete dell'installazione dell'edificio per interrompere l'alimentazione di rete dell'apparecchio e assicurare contro un reinserimento, per es. chiudendo a chiave l'interruttore.

Aprire il coperchio solo con l'arresto del rotore.

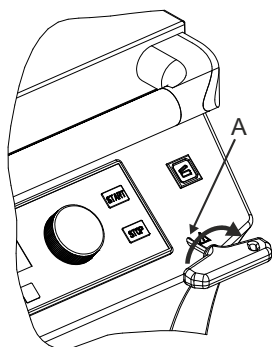

- Disinserire l'interruttore di rete (posizione di interruttore "0").
- Guardare attraverso la finestra presente nel coperchio per assicurarsi che il rotore sia fermo.
- Introdurre la chiave per viti Allen nel foro (A) e ruotarla con cautela di mezzo giro in senso orario, fino ad aprire il coperchio.
- Strappare la vite senza testa esagonale dal foro.
- Dopo la riaccensione della centrifuga, premere il tasto , in modo che la chiusura a mezzo di motore del coperchio riprenda nuovamente la posizione iniziale (apertura).

## 41 Pulizia e manutenzione



L'apparecchiatura può essere contaminata.



Prima della pulizia, staccare la presa di corrente. Negli apparecchi a collegamento fisso, disinserire l'interruttore di rete dell'installazione dell'edificio per interrompere l'alimentazione di rete dell'apparecchio e assicurare contro un reinserimento, per es. chiudendo a chiave l'interruttore.

Prima di iniziare un procedimento di pulizia e decontaminazione diverso da quello consigliato dal produttore, l'utilizzatore deve accertarsi presso il produttore che tale procedimento previsto non rechi danno all'apparecchio.

- Centrifughe, rotori e accessori non devono essere lavati in lavastoviglie.
- Si deve eseguire solo una pulizia manuale ed una disinfezione con liquido.
- La temperatura dell'acqua deve essere di 20 – 25°C.
- Devono essere utilizzati solo detersivi o disinfettanti che:
  - abbiano un campo di valori del pH che va da 5 a 8,
  - non contengano alcali caustici, perossidi, composti di cloro, acidi e soluzioni alcaline.
- Seguire attentamente le indicazioni speciali del produttore sull'impiego di detersivi e disinfettanti, al fine di evitare qualsiasi fenomeno di corrosione.

### 41.1 Centrifughe (scatola, coperchio e vano di centrifugazione)

#### 41.1.1 Cura e pulizia delle superfici

- Pulire regolarmente il corpo della centrifuga e la camera di centrifugazione e impiegare all'occorrenza sapone o un detersivo delicato e un panno umido. Ciò serve da un lato per l'igiene e dall'altro lato per evitare la corrosione causata da impurità incrostate.
- Ingredienti dei detersivi adatti: sapone, tensidi anionici, tensidi non ionici.
- Dopo l'impiego di detersivi, rimuovere i resti del detersivo pulendo di nuovo con un panno umido.
- Le superfici devono essere asciugate subito dopo la pulizia.
- In caso di formazione di acqua di condensa, asciugare la camera di centrifugazione pulendola con un panno assorbente.
- Spalmare sulla guarnizione di gomma della camera di centrifugazione, frizionando leggermente, una sostanza per la cura della gomma.
- Controllare una volta l'anno se il vano di centrifugazione presenta danneggiamenti.



Se vengono stabiliti danni rilevanti per la sicurezza, la centrifuga non deve essere più messa in funzione. In questo caso si deve contattare il servizio assistenza clienti.

#### 41.1.2 Disinfezione delle superfici

- In presenza di materiale infettivo nella camera di centrifugazione si deve disinfettarla immediatamente.
- Ingredienti dei disinfettanti adatti: etanolo, alcol n proclitico, etilexanolo, tensidi anionici, inibitori di corrosione.
- Dopo l'impiego di disinfettanti, rimuovere i resti del disinfettante pulendo di nuovo con un panno umido.
- Le superfici devono essere asciugate subito dopo la disinfezione.

#### 41.1.3 Rimuovere contaminazioni radioattive

- La sostanza deve essere certificata in modo speciale per rimuovere contaminazioni radioattive.
- Ingredienti di sostanze adatte alla rimozione di contaminazioni radioattive: tensidi anionici, tensidi non ionici, etanolo poliidrato.
- Dopo aver rimosso le contaminazioni radioattive, rimuovere i resti della sostanza pulendo di nuovo con un panno umido.
- Le superfici devono essere asciugate, subito dopo la rimozione delle contaminazioni radioattive.

## 41.2 Rotori ed accessori

### 41.2.1 Pulizia e cura

- Per prevenire corrosione e alterazioni dei materiali, i rotori e l'accessorio devono essere regolarmente puliti con sapone o con un detergente delicato e con un panno umido. Si consiglia la pulizia almeno una volta la settimana. La sporcizia deve essere subito rimossa.
- Ingredienti dei detergenti adatti:  
sapone, tensidi anionici, tensidi non ionici.
- Dopo l'impiego di detergenti, rimuovere i resti del detergente, risciacquando con acqua (solo al di fuori della centrifuga) o ripulendo con un panno umido.
- I rotori e gli accessori devono essere asciugati immediatamente dopo la pulizia.
- I rotor ad angolo, i contenitori e i supporti in alluminio devono essere ingrassati leggermente con grasso privo d'acidi come ad esempio vaselina quando sono ben asciutti.
- Le guarnizioni ad anello dei sistemi di biosicurezza sono da pulire settimanalmente.  
Le guarnizioni ad anello sono realizzate in silicone. Per garantire l'ermeticità dei sistemi di biosicurezza, dopo la pulizia od il trattamento in autoclave non è consentito il trattamento delle guarnizioni ad anello con polvere di talco.

Prima di qualsiasi utilizzo del sistema di biosicurezza deve venir controllato il perfetto stato di tutti i suoi componenti. Deve venir controllata inoltre l'esatta posizione di installazione della guarnizione ad anello ovvero delle guarnizioni ad anello del sistema di biosicurezza.

I componenti danneggiati del sistema di biosicurezza devono venire immediatamente sostituiti.

In presenza di incrinature, infragilimento od usura la guarnizione ad anello interessata deve venir sostituita immediatamente. Nel caso di coperchi con guarnizioni ad anello non sostituibili deve venir sostituito l'intero coperchio.

Per quanto riguarda i sistemi di biosicurezza fornibili, rimandiamo al capitolo "Appendice/Appendix, Rotori ed accessori/Rotors and accessories".

- Per evitare la corrosione causata dall'umidità tra il rotore e l'albero motore, si deve provvedere almeno una volta al mese di smontare il rotore, pulirlo e di lubrificare leggermente l'albero motore.
- I rotor e gli elementi accessori devono essere verificati settimanalmente per quanto riguarda il loro stato di usura ed i danneggiamenti da corrosione.

Con i motori di smorzamento devono essere verificati soprattutto il settore dei perni di supporto e per i ganci le scanalature, verificare inoltre l'eventuale presenza di incrinature nel fondo.

Esempio: Incrinatura nel settore della scanalatura.

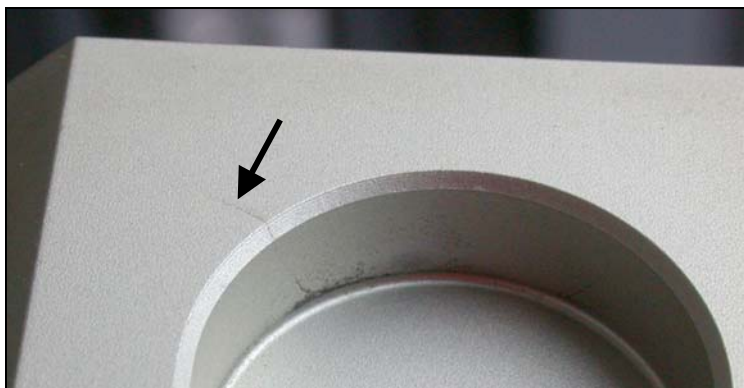

Rotori ed accessori non devono essere più utilizzati se presentano consumo o corrosione.

- Verificare settimanalmente la posizione del rotore.

### 41.2.2 Disinfezione

- Se del materiale infetto viene a contatto con i rotor o con gli accessori, allora si deve eseguire una disinfezione adeguata.
- Ingredienti dei disinfettanti adatti:  
etanolo, alcol n proclitico, etilexanolo, tensidi anionici, inibitori di corrosione.
- Dopo l'impiego di disinfettanti, rimuovere i resti del disinfettante, risciacquando con acqua (solo al di fuori della centrifuga) o ripulendo con un panno umido.
- I rotor e gli accessori devono essere asciugati immediatamente dopo la disinfezione.

### 41.2.3 Rimuovere contaminazioni radioattive

- La sostanza deve essere certificata in special modo per rimuovere contaminazioni radioattive.
- Ingredienti di sostanze adatte alla rimozione di contaminazioni radioattive: tensidi anionici, tensidi non ionici, etanolo poliidrato.
- Dopo la rimozione delle contaminazioni radioattive, rimuovere la sostanza, risciacquando con acqua (solo al di fuori della centrifuga) o ripulendo con un panno umido.
- I rotori e gli accessori devono essere asciugati subito dopo la rimozione delle contaminazioni radioattive.

### 41.2.4 Perni di trascinamento

In rotori oscillanti, i perni di trascinamento devono essere lubrificati regolarmente (Grasso lubrificante Hettich no. d'ord. 4051) per consentire un'oscillazione equilibrata dei ganci.

### 41.2.5 Rotori ed accessori con limitata durata di impiego

L'impiego di particolari rotori, ganci ed elementi accessori è limitato nel tempo.

Questi sono contrassegnati con la quantità max. di cicli di funzionamento o dalla data di scadenza ed il numero massimo di cicli di funzionamento o solo con la data di scadenza, p.es.:

- "einsetzbar bis Ende: IV. Quartal 2011 / usable until end of: IV. trimestre 2011" (utilizzabile fino alla fine: IV. trimestre 2011) o "einsetzbar bis Ende Monat/Jahr: 10/2011 / usable until end of month/year: 10/2011" (utilizzabile fino a fine mese/anno: 10/2011)
- "max. Laufzyklen / max. cycles: 40000". (Max. funzionamento cicli)



Per motivi di sicurezza l'impiego dei rotori, dei ganci e degli elementi di accessorio non è più ammesso, quando è raggiunta la quantità massima permessa dei cicli di funzionamento che è sopracontrassegnata o quando è raggiunta la data di scadenza sopracontrassegnata.

### 41.2.6 Calcolo della quantità dei cicli operativi eseguiti

Per il calcolo della quantità dei cicli operativi eseguiti (operazioni di centrifuga) sono necessari il tempo operativo per ogni operazione di centrifuga e le ore di esercizio dell'apparecchiatura.

Per l'interrogazione delle ore di esercizio vedere al capitolo "Interrogazione delle ore di esercizio".

Se le operazioni di centrifuga sono state eseguite con diversi tempi operativi, per il calcolo deve essere utilizzato il tempo operativo più basso.

La quantità dei cicli operativi eseguiti (operazioni di centrifuga) viene calcolata nel modo seguente:

Quantità cicli operativi eseguiti = Ore di esercizio [h] x 60 ÷ Tempo operativo [min]

per es.: Ore di esercizio 2000 h, tempo operativo 5 min

Quantità cicli operativi eseguiti = 2000 x 60 ÷ 5 = 24000



### 41.3 Trattamento in autoclave

I seguenti accessori possono essere trattati in autoclave a 121°C / 250°F (20 min).

- Rotori di smorzamento
- Rotori a squadra in alluminio
- Gancio in metallo
- Coperchio con ermetizzazione biologica
- Adattatore

Per quanto riguarda il grado di sterilizzazione non può essere citato alcun dato.



I coperchi dei rotor ed i serbatoi devono venir tolti prima del trattamento in autoclave.

Il trattamento in autoclave accelera il processo di invecchiamento delle plastiche. Oltre a ciò può provocare il cambiamento di colorazione delle plastiche.

Dopo il trattamento in autoclave deve venir controllata visivamente l'eventuale presenza di danneggiamenti ai rotor ed agli accessori ed i componenti eventualmente danneggiati devono essere immediatamente sostituiti.

In presenza di incrinature, fragilimento od usura la guarnizione ad anello interessata deve venir sostituita immediatamente.

Nel caso di coperchi con guarnizioni ad anello non sostituibili deve venir sostituito l'intero coperchio.

Per garantire l'ermeticità dei sistemi di biosicurezza, dopo il trattamento in autoclave non è consentito il trattamento delle guarnizioni ad anello con polvere di talco.

### 41.4 Contenitori centrifuga

- In caso di mancanza di tenuta o dopo la rottura dei contenitori per centrifugazione, rimuovere completamente i frammenti dei contenitori, le schegge di vetro e il centrifugato fuoriuscito.
- Dopo la rottura di parti in vetro, sostituire gli inserti di gomma e i manicotti di plastica dei rotor.



Le schegge di vetro rimaste causano ulteriori rotture!

- Nel caso di materiale infettivo, bisogna provvedere immediatamente ad una disinfezione.

## 42 Guasti

Se non si riesce a eliminare l'errore seguendo le indicazioni della tabella guasti, informare il servizio assistenza clienti.

Si prega di indicare il tipo di centrifuga e il numero di serie. Entrambi i numeri sono visibili sulla targhetta di modello della centrifuga.

	<p>Esecuzione di un RESET RETE:</p> <ul style="list-style-type: none"> <li>- Disinserire l'interruttore di rete (posizione interruttore "0").</li> <li>- Attendere almeno 10 secondi quindi reinserire l'interruttore di rete (posizione interruttore "1").</li> </ul>
-----------------------------------------------------------------------------------	------------------------------------------------------------------------------------------------------------------------------------------------------------------------------------------------------------------------------------------------------------------------

Visualizzazione/guasto		Causa	Eliminazione
Nessuna visualizzazione	---	Non c'è tensione. Scatto fusibile sovraccorrente.	<ul style="list-style-type: none"> <li>- Controllare alimentatore elettrico.</li> <li>- Interruttore di rete ON.</li> </ul>
TACHO - ERROR	01	Tachimetro difettoso	<ul style="list-style-type: none"> <li>- Aprire il coperchio.</li> <li>- Disinserire l'interruttore di rete (posizione interruttore "0").</li> <li>- Attendere per almeno 10 secondi.</li> <li>- Girare energicamente a mano il rotore.</li> <li>- Reinserrire l'interruttore di rete (posizione interruttore "1").</li> <li>- Durante l'inserimento il rotore deve girare</li> </ul>
	02	Rotore non installato Motore, convertitore, azionatore difettosi.	
IMBALANCE / UNWUCHT	---	Il rotore è caricato in modo non uniforme.	<ul style="list-style-type: none"> <li>- Aprire il coperchio.</li> <li>- Controllare il caricamento del rotore, vedere il capitolo "Carico del rotore".</li> <li>- Ripetere il ciclo di centrifugazione.</li> </ul>
CONTROL - ERROR	04, 06 - 09	Errore blocco coperchio, ovvero chiusura coperchio.	<ul style="list-style-type: none"> <li>- Esecuzione di un RESET RETE.</li> </ul>
N > MAX	05	N° giri eccedente	
N < MIN	13	N° giri insufficiente	
ROTORCODE	10	Errore codifica rotore	
MAINS INTERRUPT	---	Interruzione di rete durante il ciclo di centrifugazione. (Il ciclo di centrifugazione non viene terminato.)	<ul style="list-style-type: none"> <li>- Aprire il coperchio.</li> <li>- Premere tasto <b>START</b>.</li> <li>- All'occorrenza ripetere il ciclo di centrifugazione.</li> </ul>
VERSIONS-ERROR	12	Non c'è corrispondenza tra i componenti elettronici	<ul style="list-style-type: none"> <li>- Esecuzione di un RESET RETE.</li> </ul>
SER I/O - ERROR	30 - 38	Errore/guasto interfaccia	
° C * - ERROR	50 - 56, 58	Errore/guasto raffreddamento	
LOCK - ERROR	57	Errore/guasto blocco programma	
FU / CCI - ERROR	60 - 83	Errore/guasto controllo motore	
CONTROL-ERROR	26, 90 - 95, 97 - 99	Errore/guasto lato comandi	
N > ROTOR-MAX	96	Il numero di giri nel programma selezionato è superiore al numero di giri massimo del rotore (n-max-Rotor).	<ul style="list-style-type: none"> <li>- Verificare e correggere la velocità nel programma selezionato.</li> </ul>
		Il rotore è stato cambiato. Il rotore installato ha un numero di giri superiore del precedente e non è stato ancora riconosciuto.	<ul style="list-style-type: none"> <li>- Impostare un numero di giri massimo superiore a quello del rotore precedentemente utilizzato. Premere il tasto <b>START</b> per effettuare il riconoscimento del rotore, vedi capitolo "Riconoscimento del rotore".</li> </ul>

### 43 Rispedizione di apparecchi

Se l'apparecchio o uno dei suoi accessori viene rispedito alla ditta Andreas Hettich GmbH & Co. KG, esso deve essere prima decontaminato e pulito per la tutela di persone, ambiente e materiale.

Ci riserviamo la facoltà di accettare apparecchi o accessori contaminati.

Eventuali costi di pulizia e disinfezione verranno fatturati al cliente.

Contiamo a questo riguardo sulla vostra comprensione.

### 44 Smaltimento



#### **L'apparecchio può essere smaltito contattando il costruttore.**

Per il reso richiedere sempre l'apposito modulo (RMA).

In caso di necessità contattare l'assistenza tecnica del costruttore:

Andreas Hettich GmbH & Co. KG

Föhrenstraße 12

78532 Tuttlingen, Germania

Telefono: +49 7461 705 1400

E-mail: [service@hettichlab.com](mailto:service@hettichlab.com)

Lo smaltimento potrebbe essere a pagamento.



#### **ATTENZIONE**

#### **Pericolo di inquinamento e contaminazione per l'uomo e l'ambiente**

Uno smaltimento inappropriato o non conforme della centrifuga può essere causa di inquinamento o contaminazione per l'uomo e l'ambiente.

- Lo smontaggio e lo smaltimento devono essere effettuati esclusivamente da personale tecnico esperto e autorizzato.

L'apparecchio è destinato al settore commerciale ("Business to Business" - B2B).

Ai sensi della direttiva 2012/19/UE gli apparecchi non devono essere smaltiti insieme ai normali rifiuti.

Secondo lo Stiftung Elektro-Altgeräte Register (EAR) gli apparecchi vengono classificati nei seguenti gruppi.

- Gruppo 1 (Scambiatori di calore)











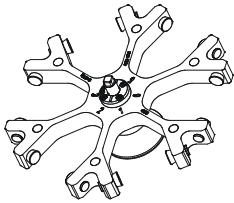

























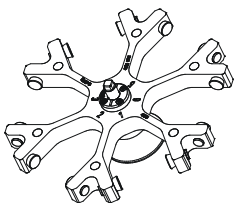









Il simbolo del bidone della spazzatura barrato indica che l'apparecchio non può essere smaltito insieme ai normali rifiuti.

I regolamenti in materia di smaltimento dei singoli Paesi possono essere differenti. In caso di necessità contattare il fornitore.

45 Anhang / Appendix











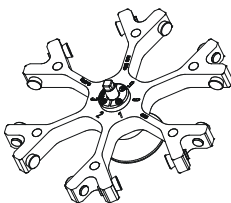







45.1 Rotoren und Zubehör / Rotors and accessories







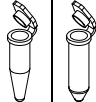

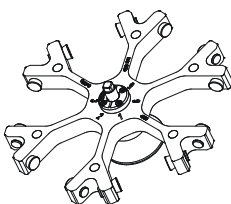

4296	5051 + 5053									
<p><b>Ausschwingrotor 6-fach / Swing out rotor 6-times</b></p>  <p>max. Laufzyklen / max. cycles 120000</p> <p>∠ 90°</p>	 									
	max. Laufzyklen / max. cycles: 50000 max. Beladung / max. load: 500 g									
	5262	5249	5243	5243 + 6316	5242	5247	5227	5257		
										
			Falcon®							
										
Kapazität / capacity ml	100	100	50	50	25	7	5	6	1,5	2
Maße / dimensions Ø x L mm	44 x 100	40 x 115	34 x 100	29 x 115	24 x 100	12 x 100	12 x 75	12 x 82	11 x 38	
Anzahl p. Rotor / number p. rotor	6	6	12	12	30	120	120		240	
Drehzahl / speed RPM	4000	4000	4000	4000	4000	4000	4000		4000	
RZB / RCF <sup>2)</sup>	3291	3291	3291	3291	3291	3291	3309		2486 / 3363	
Radius / radius mm	184	184	184	184	184	184	185		139/188	
 9 (97%) sec						33				
 9 sec						50				
Temperatur / temperature °C <sup>1)</sup>						0				

4296	5051 + 5053									
<p><b>Ausschwingrotor 6-fach / Swing out rotor 6-times</b></p>  <p>max. Laufzyklen / max. cycles 120000</p> <p>∠ 90°</p>	 									
	max. Laufzyklen / max. cycles: 50000 max. Beladung / max. load: 500 g									
	5248-91	5247-91	5266	5258	5264	5227	5248			
10)	10)									
										
Kapazität / capacity ml	15	7	30	9-10	4-5,5	7,5-8,5	2,7-3	4,5-5	15	
Maße / dimensions Ø / L mm <sup>2</sup>	17 x 100	12 x 100	25 x 110	16 x 92	15 x 75	15 x 92	11 x 66	11 x 92	17 x 100	
Anzahl p. Rotor / number p. rotor	72	120	30	66	72	72	120		72	
Drehzahl / speed RPM	4000	4000	4000	4000	4000	4000	4000		4000	
RZB / RCF <sup>2)</sup>	3291	3291	3291	3291	3309	3309	3309		3291	
Radius / radius mm	184	184	184	184	185	185	185		184	
 9 (97%) sec						33				
 9 sec						50				
Temperatur / temperature °C <sup>1)</sup>						0				

- 1) Tiefste erreichbare Temperatur bei maximaler Drehzahl, 1 h Laufzeit und 20°C Raumtemperatur (nur bei Kühlzentrifuge)
- 2) Angaben des Röhrchenherstellers beachten.
- 3) nicht mit Deckel 5053 verschließbar
- 10) mit Dekantierhilfe











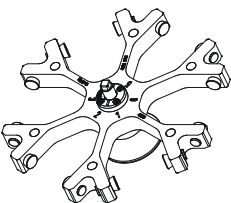



- 1) Lowest possible temperature during maximum speed, 1 h running time and 20°C ambient temperature (only with cooling centrifuges)
- 2) Observe the tube manufacturer's instructions.
- 3) not possible to close the lid 5053
- 10) with decanting aid









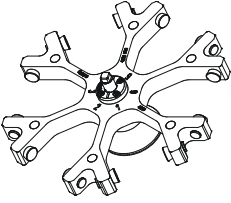
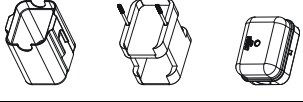

4296	5051 + 5053									
<p><b>Ausschwingrotor 6-fach / Swing out rotor 6-times</b></p>  <p>max. Laufzyklen / max. cycles 120000</p> <p>∠ 90°</p>	 									
	max. Laufzyklen / max. cycles: 50000 max. Beladung / max. load: 500 g									
	5259	6306	5248	5264	5267	5281				
	 3)	 3)								
										
Kapazität / capacity ml	50	15	8,5 - 10	4 - 7	9	1,1-1,4	3	1,5	2,0	
Maße / dimensions Ø x L mm	29 x 115	17 x 120	16 x 100	16 x 75	14 x 100	8 x 66	10 x 60	11 x 38		
Anzahl p. Rotor / number p. rotor	12	42	72	72	72	120	120	96		
Drehzahl / speed RPM	4000	4000	4000	4000	4000	4000	4000	4000		
RZB / RCF <sup>2)</sup>	3363	3434	3291	3309	3309	3274	3274	3363		
Radius / radius mm	188	192	184	185	185	183	183	188		
 9 (97%) sec						33				
 9 sec						50				
Temperatur / temperature °C <sup>1)</sup>						0				

4296	5051 + 5053									
<p><b>Ausschwingrotor 6-fach / Swing out rotor 6-times</b></p>  <p>max. Laufzyklen / max. cycles 120000</p> <p>∠ 90°</p>	 									
	max. Laufzyklen / max. cycles: 50000 max. Beladung / max. load: 500 g									
	5268									
										
										
Kapazität / capacity ml	1,6 - 5	4 - 7	5	2,6 - 3,4	4,9					
Maße / dimensions Ø x L mm	13 x 75	13 x 100	13 x 75	13 x 65	13 x 90					
Anzahl p. Rotor / number p. rotor	72	72	72	72	72					
Drehzahl / speed RPM	4000	4000	4000	4000	4000					
RZB / RCF <sup>2)</sup>	3345	3345	3345	3345	3345					
Radius / radius mm	187	187	187	187	187					
 9 (97%) sec						33				
 9 sec						50				
Temperatur / temperature °C <sup>1)</sup>						0				

1) Tiefste erreichbare Temperatur bei maximaler Drehzahl, 1 h Laufzeit und 20°C Raumtemperatur (nur bei Kühlzentrifuge)  
 2) Angaben des Röhrchenherstellers beachten.  
 3) nicht mit Deckel 5053 verschließbar











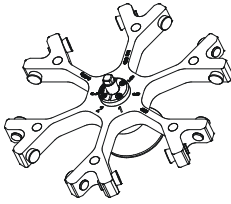





1) Lowest possible temperature during maximum speed, 1 h running time and 20°C ambient temperature (only with cooling centrifuges)  
 2) Observe the tube manufacturer's instructions.  
 3) not possible to close the lid 5053

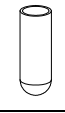
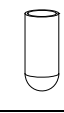

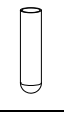







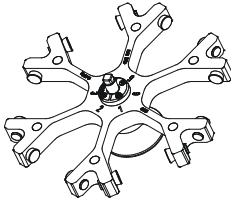







4296		5051 + 5280 5053							
<b>Ausschwingrotor 6-fach / Swing out rotor 6-times</b>    $\angle 90^\circ$  max. Laufzyklen / max. cycles 120000									
		1662						1670	
								 4)	
		1663	1664	1665	1666	1667	1668	1663	1664
									
Kapazität / capacity	ml	1	2	4	8	3 x 2	4 x 1	1	2
Maße / dimensions $\varnothing$ / A	mm <sup>2</sup>	6,2 / 30	8,7 / 60	12,4 / 120	17,5 / 240	8,7 / 60	6,2 / 30	6,2 / 30	8,7 / 60
Anzahl p. Rotor / number p. rotor		12	12	12	12	12	12	12	12
Filterkarten / filter cards		1675	1675	1675	1676	1677	1668	1692	1692
Drehzahl / speed	RPM	4000	4000	4000	4000	4000	4000	4000	4000
RZB / RCF	<sup>2)</sup>	2290 / 3274	2290 / 3274	2290 / 3274	2290 / 3274	2290 / 3274	2290 / 3274	2290 / 3274	2290 / 3274
Radius / radius	mm	128 / 183	128 / 183	128 / 183	128 / 183	128 / 183	128 / 183	128 / 183	128 / 183
 9 (97%)	sec							33	
 9	sec							50	
Temperatur / temperature	°C <sup>1)</sup>							0	

4296		5051 + 5280 5053							
<b>Ausschwingrotor 6-fach / Swing out rotor 6-times</b>    $\angle 90^\circ$  max. Laufzyklen / max. cycles 120000									
		1670			1470				
		 4)							
		1665	1666	1667	1668	1475	1471		
									
Kapazität / capacity	ml	4	8	3 x 2	4 x 1	2 x 8	1 x 8		
Maße / dimensions $\varnothing$ / A	mm <sup>2</sup>	12,4 / 120	17,5 / 240	8,7 / 60	6,2 / 30	17,5 / 240	17,5 / 240		
Anzahl p. Rotor / number p. rotor		12	12	12	12	12	12		
Filterkarten / filter cards		1692	1691	1694	1693	---	---		
Drehzahl / speed	RPM	4000	4000	4000	4000	4000	4000		
RZB / RCF	<sup>2)</sup>	2290 / 3274	2290 / 3274	2290 / 3274	2290 / 3274	2200 / 3202	2200 / 3202		
Radius / radius	mm	128 / 183	128 / 183	128 / 183	128 / 183	123 / 179	123 / 179		
 9 (97%)	sec							33	
 9	sec							50	
Temperatur / temperature	°C <sup>1)</sup>							0	

- 1) Tiefste erreichbare Temperatur bei maximaler Drehzahl, 1 h Laufzeit und 20°C Raumtemperatur (nur bei Kühlzentrifuge)
- 2) Angaben des Röhrchenherstellers beachten.
- 4) Objektträger nur belastbar bis RZB 1100











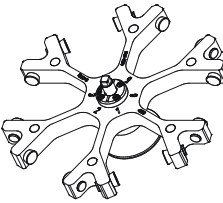

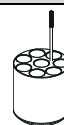

- 1) Lowest possible temperature during maximum speed, 1 h running time and 20°C ambient temperature (only with cooling centrifuges)
- 2) Observe the tube manufacturer's instructions.
- 4) Object slide will not stand RCF values exceeding 1100











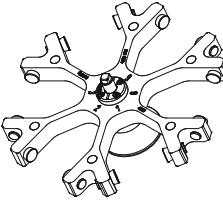

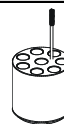

4296	5092 + 5093									
<b>Ausschwingrotor 6-fach / Swing out rotor 6-times</b>    $\angle 90^\circ$  max. Laufzyklen / max. cycles 120000	 									
	mit Bioabdichtung / with bio-containment 5)									
	max. Laufzyklen / max. cycles: 30000 max. Beladung / max. load: 500 g									
		5126	5125	5123	5124	5122		5128		
										
										
Kapazität / capacity ml	100	100	50	50	25	30	4	5	6	
Maße / dimensions $\varnothing$ x L mm	40 x 115	44 x 100	29 x 115	34 x 100	24 x 100	25 x 110	12 x 60	12 x 75	12 x 82	
Anzahl p. Rotor / number p. rotor	6	6	12	6	24	24	72		72	
Drehzahl / speed RPM	4000	4000	4000	4000	4000	4000	4000		4000	
RZB / RCF <sup>2)</sup>	3488	3488	3631	3488	3434	3434	3542		3542	
Radius / radius mm	195	195	203	195	192	192	198		198	
 9 (97%) sec					33					
 9 sec					50					
Temperatur / temperature °C <sup>1)</sup>					- 2					

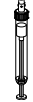
4296	5092 + 5093									
<b>Ausschwingrotor 6-fach / Swing out rotor 6-times</b>    $\angle 90^\circ$  max. Laufzyklen / max. cycles 120000	 									
	mit Bioabdichtung / with bio-containment 5)									
	max. Laufzyklen / max. cycles: 30000 max. Beladung / max. load: 500 g									
		5120			5121				5121-93	
										
										
Kapazität / capacity ml	7	4,5 - 5	4 - 7	2,6 - 3,4	9 - 10	10	8,5 - 10	8	15	4 - 7
Maße / dimensions $\varnothing$ x L mm	12 x 100	11 x 92	13 x 100	13 x 65	16 x 92	15 x 102	16 x 100	16 x 125	17 x 100	16 x 75
Anzahl p. Rotor / number p. rotor	72	72	72	42	42		42		42	42
Drehzahl / speed RPM	4000	4000	4000	4000	4000	4000	4000	4000	4000	4000
RZB / RCF <sup>2)</sup>	3542	3542	3542	3542	3542	3542	3542	3542	3542	3542
Radius / radius mm	198	198	198	198	198	198	198	198	198	198
 9 (97%) sec					33					
 9 sec					50					
Temperatur / temperature °C <sup>1)</sup>					- 2					

- 1) Tiefste erreichbare Temperatur bei maximaler Drehzahl, 1 h Laufzeit und 20°C Raumtemperatur (nur bei Kühlzentrifuge)
- 2) Angaben des Röhrchenherstellers beachten.
- 3) nicht mit Deckel 5053 verschließbar
- 5) Nach DIN EN 61010, Teil 2 – 020. Die Hinweise für Bio-Sicherheitssysteme in den Kapiteln "Sicherheitshinweise" und "Pflege und Wartung" beachten.

- 1) Lowest possible temperature during maximum speed, 1 h running time and 20°C ambient temperature (only with cooling centrifuges)
- 2) Observe the tube manufacturer's instructions.
- 3) not possible to close the lid 5053
- 5) in conformity with DIN EN 61010, part 2 – 020. Observe the notes for bio safety systems in chapters "Notes on safety" and "Maintenance and servicing".











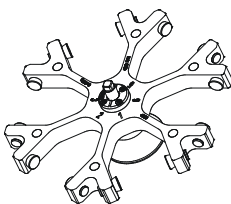

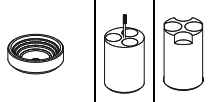

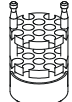
<p><b>4296</b></p> <p><b>Ausschwingrotor 6-fach / Swing out rotor 6-times</b></p>  <p>∠ 90°</p> <p>max. Laufzyklen / max. cycles 120000</p>	<b>5092 + 5093</b>		 		mit Bioabdichtung / with bio-containment 5)		max. Laufzyklen / max. cycles: 30000 max. Beladung / max. load: 500 g		5136			
												
	Kapazität / capacity	ml	10	15	10	4 – 4,5	7,5 - 8,5	9 - 10	10	4 - 7	8,5 - 10	
	Maße / dimensions	∅ x L	mm	16 x 80	17 x 100	17 x 70	15 x 75	15 x 92	16 x 92	15 x 102	16 x 75	16 x 100
	Anzahl p. Rotor / number p. rotor			48	48	48	48	48	48	48	48	
	Drehzahl / speed	RPM		4000	4000	4000	4000	4000	4000	4000	4000	
	RZB / RCF			3488	3488	3488	3488	3488	3488	3488	3488	
	Radius / radius	mm		195	195	195	195	195	195	195	195	
	 9 (97%)	sec		33								
	 9	sec		50								
Temperatur / temperature	°C <sup>1)</sup>		- 2									

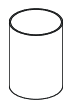
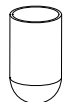





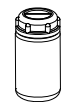
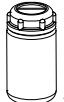

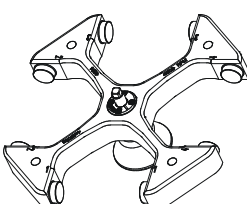
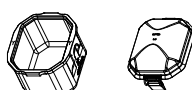
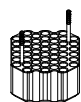

<p><b>4296</b></p> <p><b>Ausschwingrotor 6-fach / Swing out rotor 6-times</b></p>  <p>∠ 90°</p> <p>max. Laufzyklen / max. cycles 120000</p>	<b>5092 + 5093</b>		 		mit Bioabdichtung / with bio-containment 5)		max. Laufzyklen / max. cycles: 30000 max. Beladung / max. load: 500 g		5137			
												
	Kapazität / capacity	ml	1,6 - 5	4 - 7	4,9	1,1 - 1,4	2,6 – 3,4	2,7 - 3	4,5 - 5	5		
	Maße / dimensions	∅ x L	mm	13 x 75	13 x 100	13 x 90	8 x 66	13 x 65	11 x 66	11 x 92	13 x 75	
	Anzahl p. Rotor / number p. rotor			48	48	48	48	48	48	48	48	
	Drehzahl / speed	RPM		4000	4000	4000	4000	4000	4000	4000	4000	
	RZB / RCF			3488	3488	3488	3488	3488	3488	3488	3488	
	Radius / radius	mm		195	195	195	195	195	195	195	195	
	 9 (97%)	sec		33								
	 9	sec		50								
Temperatur / temperature	°C <sup>1)</sup>		- 2									

- 1) Tiefste erreichbare Temperatur bei maximaler Drehzahl, 1 h Laufzeit und 20°C Raumtemperatur (nur bei Kühlzentrifuge)
- 2) Angaben des Röhrchenherstellers beachten.
- 5) Nach DIN EN 61010, Teil 2 – 020. Die Hinweise für Bio-Sicherheitssysteme in den Kapiteln "Sicherheitshinweise" und "Pflege und Wartung" beachten.

- 1) Lowest possible temperature during maximum speed, 1 h running time and 20°C ambient temperature (only with cooling centrifuges)
- 2) Observe the tube manufacturer's instructions.
- 5) In conformity with DIN EN 61010, part 2 – 020. Observe the notes for bio safety systems in chapters "Notes on safety" and "Maintenance and servicing".











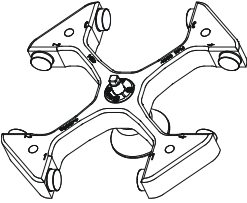



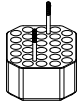
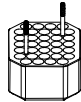
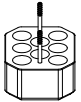
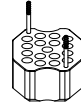
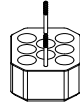
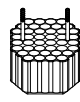

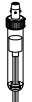







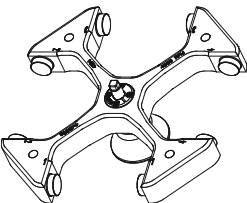

4296		5092 + 5093							5092		
<b>Ausschwingrotor 6-fach / Swing out rotor 6-times</b>  $\angle 90^\circ$ max. Laufzyklen / max. cycles 120000											
		mit Bioabdichtung / with bio-containment $\S$ max. Laufzyklen / max. cycles: 30000 max. Beladung / max. load: 500 g									
		1791	5134	5135	5129	5138			6319	6319	
											
											
Kapazität / capacity	ml	250	25	50	15	1.1 – 1.4	2.7 - 3	2.6 – 3.4	1.6 – 5	250	290
Maße / dimensions $\varnothing$ x L	mm	65 x 115	25 x 90	29 x 115	17 x 120	8 x 66	11 x 66	13 x 65	13 x 75	62 x 122	62 x 137
Anzahl p. Rotor / number p. rotor		6	18	12	42	72	72	72	72	6	6
Drehzahl / speed	RPM	4000	4000	4000	4000	4000	4000	4000	4000	4000	4000
RZB / RCF	<sup>2)</sup>	3631	3363	3560	3631	3077	3077	3077	3077	3631	3631
Radius / radius	mm	203	188	199	203	172	172	172	172	203	203
 9 (97%)	sec						33				
 9	sec						50				
Temperatur / temperature	$^{\circ}\text{C}$ <sup>1)</sup>						- 2				

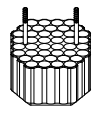
4294		4290 + 4291							
<b>Ausschwingrotor 4-fach / Swing out rotor 4-times</b>  $\angle 90^\circ$ max. Laufzyklen / max. cycles 40000									
		max. Laufzyklen / max. cycles: 30000 (4500 RPM), 45000 (4000 RPM), 60000 (3500 RPM) max. Beladung / max. load: 1200 g							
		mit Bioabdichtung / with bio-containment $\S$ 4273							
									
									
Kapazität / capacity	ml	5	6	7	2,6 - 3,4	4,9	1,6 - 5	4 - 7	
Maße / dimensions $\varnothing$ x L	mm	12 x 75	12 x 82	12 x 100	13 x 65	13 x 90	13 x 75	13 x 100	
Anzahl p. Rotor / number p. rotor		200	200	200	200	200	200	200	
Drehzahl / speed	RPM	4500							
RZB / RCF	<sup>2)</sup>	4551							
Radius / radius	mm	201							
 9 (97%)	sec	115							
 9	sec	116							
Temperatur / temperature	$^{\circ}\text{C}$ <sup>1)</sup>	2							

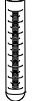
- 1) Tiefste erreichbare Temperatur bei maximaler Drehzahl, 1 h Laufzeit und 20°C Raumtemperatur (nur bei Kühlzentrifuge)
- 2) Angaben des Röhrchenherstellers beachten.
- 5) Nach DIN EN 61010, Teil 2 – 020. Die Hinweise für Bio-Sicherheitssysteme in den Kapiteln "Sicherheitshinweise" und "Pflege und Wartung" beachten.









- 1) Lowest possible temperature during maximum speed, 1 h running time and 20°C ambient temperature (only with cooling centrifuges)
- 2) Observe the tube manufacturer's instructions.
- 5) In conformity with DIN EN 61010, part 2 – 020. Observe the notes for bio safety systems in chapters "Notes on safety" and "Maintenance and servicing".

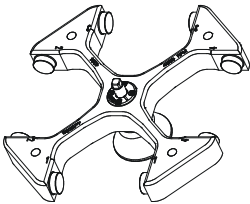

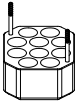
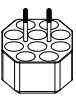
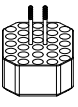







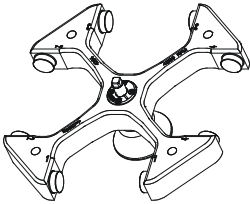

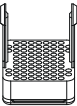
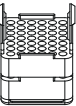
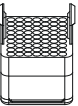
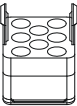
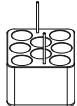
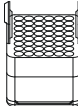
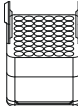

4294		4290 + 4291							
<b>Ausschwingrotor 4-fach / Swing out rotor 4-times</b>   max. Laufzyklen / max. cycles 40000		 							
		max. Laufzyklen / max. cycles: 30000 (4500 RPM); 45000 (4000 RPM), 60000 (3500 RPM) max. Beladung / max. load: 1200 g mit Bioabdichtung / with bio-containment <sup>s)</sup>							
		4310	4311	4313	4314	4321	4338		
									
									
Kapazität / capacity	ml	12	10	9 - 10	50	15	50	10	
Maße / dimensions	∅ x L mm	17 x 100	15 x 102	16 x 92	29 x 115	17 x 120	29 x 115	16 x 80	
Anzahl p. Rotor / number p. rotor		112	132	132	32	68	32	168	
Drehzahl / speed	RPM	4500	4500	4500	4500	4500	4500	4500	
RZB / RCF	<sup>2)</sup>	4437	4573	4573	4528	4618	4618	4551	
Radius / radius	mm	196	202	202	200	204	204	201	
	9 (97%)							115	
	9							116	
Temperatur / temperature	°C <sup>1)</sup>							2	

4294		4290 + 4291						
<b>Ausschwingrotor 4-fach / Swing out rotor 4-times</b>   max. Laufzyklen / max. cycles 40000		 						
		max. Laufzyklen / max. cycles: 30000 (4500 RPM); 45000 (4000 RPM), 60000 (3500 RPM) max. Beladung / max. load: 1200 g mit Bioabdichtung / with bio-containment <sup>s)</sup>						
		4338						
								
								
Kapazität / capacity	ml	9	14	15	4 - 5,5	7,5 - 8,5	4 - 7	8,5 - 10
Maße / dimensions	∅ x L mm	14 x 100	16 x 101	17 x 100	15 x 75	15 x 92	16 x 75	16 x 100
Anzahl p. Rotor / number p. rotor		168	168	168	168	168	168	168
Drehzahl / speed	RPM	4500						
RZB / RCF	<sup>2)</sup>	4551						
Radius / radius	mm	201						
	9 (97%)							115
	9							116
Temperatur / temperature	°C <sup>1)</sup>							2

- 1) Tiefste erreichbare Temperatur bei maximaler Drehzahl, 1 h Laufzeit und 20°C Raumtemperatur (nur bei Kühlzentrifuge)
- 2) Angaben des Röhrchenherstellers beachten.
- 5) Nach DIN EN 61010, Teil 2 – 020. Die Hinweise für Bio-Sicherheitssysteme in den Kapiteln "Sicherheitshinweise" und "Pflege und Wartung" beachten.









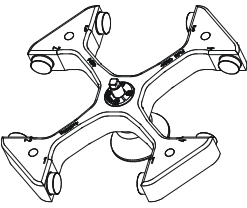
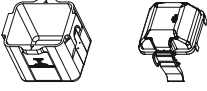
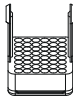
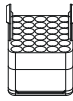
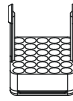

- 1) Lowest possible temperature during maximum speed, 1 h running time and 20°C ambient temperature (only with cooling centrifuges)
- 2) Observe the tube manufacturer's instructions.
- 5) In conformity with DIN EN 61010, part 2 – 020. Observe the notes for bio safety systems in chapters "Notes on safety" and "Maintenance and servicing".









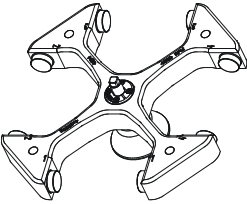
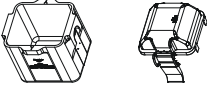
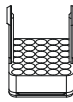

4294		4290						
<b>Ausschwingrotor 4-fach / Swing out rotor 4-times</b>    90°  max. Laufzyklen / max. cycles 40000		  max. Laufzyklen / max. cycles: 30000 (4500 RPM); 45000 (4000 RPM), 60000 (3500 RPM) max. Beladung / max. load: 1200 g						
		4339	4323	4320				
								
								
Kapazität / capacity	ml	50	50	15				
Maße / dimensions	∅ x L	mm	29 x 115	29 x 115	17 x 120			
Anzahl p. Rotor / number p. rotor		40	40	112				
Drehzahl / speed	RPM	4500	4500	4500				
RZB / RCF	<sup>2)</sup>	4528	4618	4618				
Radius / radius	mm	200	204	204				
 9 (97%)	sec							115
 9	sec							116
Temperatur / temperature	°C <sup>1)</sup>							2

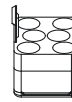
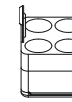
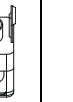
4294		4295-A + 4229-B								
<b>Ausschwingrotor 4-fach / Swing out rotor 4-times</b>    90°  max. Laufzyklen / max. cycles 40000		   max. Laufzyklen / max. cycles: 15000 (4500 RPM); 50000 (4000 RPM) max. Beladung / max. load: 1060 g								
		4226	4225	4224	4241	4245-A	4213			
										
										
Kapazität / capacity	ml	0.8	1.5	2.0	4	25	50	6	7	4.5 - 5
Maße / dimensions	∅ x L	mm	8 x 45	11 x 38	10 x 88	25 x 90	29 x 115	12 x 82	12 x 100	11 x 92
Anzahl p. Rotor / number p. rotor		312	336	252	32	32	32	192	192	192
Drehzahl / speed	RPM	4500	4500	4500	4500	4500	4500	4500	4500	4500
RZB / RCF	<sup>2)</sup>	4777	3690 / 4887	4777	4777	4777	4958	4777	4777	4777
Radius / radius	mm	211	163 / 215	211	211	211	219	211	211	211
 9 (97%)	sec							115		
 9	sec							116		
Temperatur / temperature	°C <sup>1)</sup>							6		











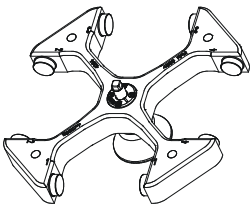

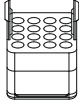
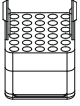
1) Tiefste erreichbare Temperatur bei maximaler Drehzahl, 1 h Laufzeit und 20°C Raumtemperatur (nur bei Kühlzentrifuge)  
2) Angaben des Röhrchenherstellers beachten.









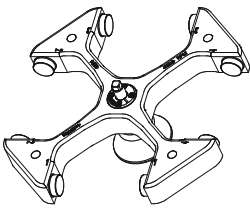
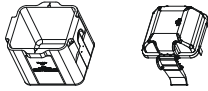
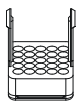
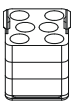
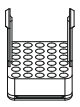
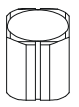

1) Lowest possible temperature during maximum speed, 1 h running time and 20°C ambient temperature (only with cooling centrifuges)  
2) Observe the tube manufacturer's instructions.

4294		4295-A + 4229-B							
<b>Ausschwingrotor 4-fach / Swing out rotor 4-times</b>  max. Laufzyklen / max. cycles 40000 90°									
		max. Laufzyklen / max. cycles: 15000 (4500 RPM); 50000 (4000 RPM) max. Beladung / max. load: 1060 g							
		4213-93			4214			4214-93	
									
									
Kapazität / capacity	ml	5	6	2,7 - 3	15	7,5 - 8,2	8,5 - 10	10	4 - 7
Maße / dimensions	∅ x L mm	12 x 75	12 x 82	11 x 66	17 x 100	15 x 92	16 x 100	15 x 102	16 x 75
Anzahl p. Rotor / number p. rotor		192	192	192	120	120	120	120	120
Drehzahl / speed	RPM	4500	4500	4500	4500	4500	4500	4500	4500
RZB / RCF	<sup>2)</sup>	4777	4777	4777	4777	4777	4777	4777	4777
Radius / radius	mm	211	211	211	211	211	211	211	211
 9 (97%)	sec	115							
 9	sec	116							
Temperatur / temperature	°C <sup>1)</sup>	6							



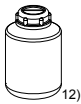





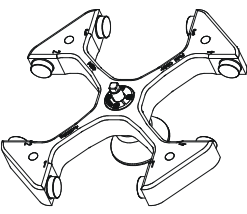

4294		4295-A + 4229-B					
<b>Ausschwingrotor 4-fach / Swing out rotor 4-times</b>  max. Laufzyklen / max. cycles 40000 90°							
		max. Laufzyklen / max. cycles: 15000 (4500 RPM); 50000 (4000 RPM) max. Beladung / max. load: 1060 g					
		4214-93	4215	4216	4218	4238	
							
						 <sup>12)</sup>	
Kapazität / capacity	ml	4 - 4,5	25	50	100	250	
Maße / dimensions	∅ x L mm	15 x 75	24 x 100	34 x 100	40 x 115	62 x 122	
Anzahl p. Rotor / number p. rotor		120	44	24	16	4	
Drehzahl / speed	RPM	4500	4500	4500	4500	4500	
RZB / RCF	<sup>2)</sup>	4777	4777	4777	4777	4777	
Radius / radius	mm	211	211	211	211	211	
 9 (97%)	sec	115					
 9	sec	116					
Temperatur / temperature	°C <sup>1)</sup>	6					

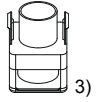
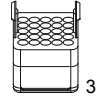
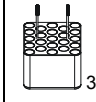
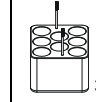
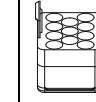





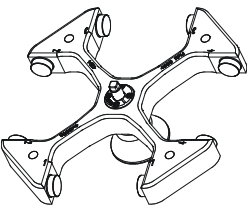

- |                                                                                                                                                                                                                                                                                               |                                                                                                                                                                                                                                                                                                       |
|-----------------------------------------------------------------------------------------------------------------------------------------------------------------------------------------------------------------------------------------------------------------------------------------------|-------------------------------------------------------------------------------------------------------------------------------------------------------------------------------------------------------------------------------------------------------------------------------------------------------|
| <p>1) Tiefste erreichbare Temperatur bei maximaler Drehzahl, 1 h Laufzeit und 20°C Raumtemperatur (nur bei Kühlzentrifuge)</p> <p>2) Angaben des Röhrchenherstellers beachten.</p> <p>12) Bei Temperaturen über 40 °C und/oder geringer Befüllung der Gefäße können sich diese verformen.</p> | <p>1) Lowest possible temperature during maximum speed, 1 h running time and 20°C ambient temperature (only with cooling centrifuges)</p> <p>2) Observe the tube manufacturer's instructions.</p> <p>12) At temperatures above 40 °C and/or poor filling of the tubes, these can go out of shape.</p> |
|-----------------------------------------------------------------------------------------------------------------------------------------------------------------------------------------------------------------------------------------------------------------------------------------------|-------------------------------------------------------------------------------------------------------------------------------------------------------------------------------------------------------------------------------------------------------------------------------------------------------|

4294	4295-A + 4229-B								
<b>Ausschwingrotor 4-fach / Swing out rotor 4-times</b>  max. Laufzyklen / max. cycles 40000 90°	 max. Laufzyklen / max. cycles: 15000 (4500 RPM); 50000 (4000 RPM) max. Beladung / max. load: 1060 g								
	4220		4222		4223				
									
									
Kapazität / capacity ml	9 - 10	12	4 - 7	7	9	12			
Maße / dimensions Ø x L mm	16 x 92	17 x 100	13 x 100	12 x 100	14 x 100	16 x 101			
Anzahl p. Rotor / number p. rotor	64	64	120	120	100	100			
Drehzahl / speed RPM	4500	4500	4500	4500	4500	4500			
RZB / RCF <sup>2)</sup>	4777	4777	4777	4777	4777	4777			
Radius / radius mm	211	211	211	211	211	211			
 9 (97%) sec								115	
 9 sec								116	
Temperatur / temperature °C <sup>1)</sup>								6	



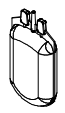

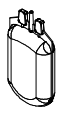
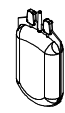
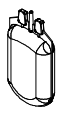
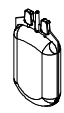
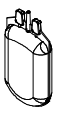





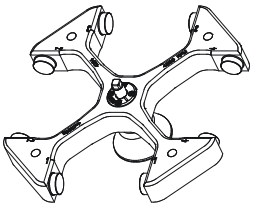
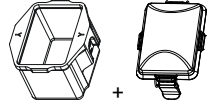

4294	4295-A + 4229-B								
<b>Ausschwingrotor 4-fach / Swing out rotor 4-times</b>  max. Laufzyklen / max. cycles 40000 90°	 max. Laufzyklen / max. cycles: 15000 (4500 RPM); 50000 (4000RPM) max. Beladung / max. load: 1060 g								
	4223-93		4249		4222-93		4258		
									
									
Kapazität / capacity ml	4 - 7	50	2,6 - 3,4	1,6 - 5	750	750	500	650	
Maße / dimensions Ø x L mm	16 x 75	29 x 115	13 x 65	13 x 75	96 x 135	97 x 152	96 x 147	97 x 139	
Anzahl p. Rotor / number p. rotor	100	24	120	120	4	4	4	4	
Drehzahl / speed RPM	4500	4500	4500	4500	4500	4500	4500	4500	
RZB / RCF <sup>2)</sup>	4777	4867	4777	4777	4958	4958	4958	4958	
Radius / radius mm	211	215	211	211	219	219	219	219	
 9 (97%) sec								115	
 9 sec								116	
Temperatur / temperature °C <sup>1)</sup>								6	

- |                                                                                                                                                                                                                                                                                                                                                                                         |                                                                                                                                                                                                                                                                                                                                                                                                             |
|-----------------------------------------------------------------------------------------------------------------------------------------------------------------------------------------------------------------------------------------------------------------------------------------------------------------------------------------------------------------------------------------|-------------------------------------------------------------------------------------------------------------------------------------------------------------------------------------------------------------------------------------------------------------------------------------------------------------------------------------------------------------------------------------------------------------|
| <p>1) Tiefste erreichbare Temperatur bei maximaler Drehzahl, 1 h Laufzeit und 20°C Raumtemperatur (nur bei Kühlzentrifuge)</p> <p>2) Angaben des Röhrchenherstellers beachten.</p> <p>3) nicht mit Deckel 4229-B verschließbar</p> <p>6) Gefäß nur belastbar bis RZB 700</p> <p>12) Bei Temperaturen über 40 °C und/oder geringer Befüllung der Gefäße können sich diese verformen.</p> | <p>1) Lowest possible temperature during maximum speed, 1 h running time and 20°C ambient temperature (only with cooling centrifuges)</p> <p>2) Observe the tube manufacturer's instructions.</p> <p>3) not possible to close the lid 4229-B</p> <p>6) tube will not stand RCF values exceeding 700</p> <p>12) At temperatures above 40 °C and/or poor filling of the tubes, these can go out of shape.</p> |
|-----------------------------------------------------------------------------------------------------------------------------------------------------------------------------------------------------------------------------------------------------------------------------------------------------------------------------------------------------------------------------------------|-------------------------------------------------------------------------------------------------------------------------------------------------------------------------------------------------------------------------------------------------------------------------------------------------------------------------------------------------------------------------------------------------------------|

4294		4295-A + 4229-B						
<b>Ausschwingrotor 4-fach / Swing out rotor 4-times</b>  $\angle 90^\circ$ max. Laufzyklen / max. cycles 40000		 						
		max. Laufzyklen / max. cycles: 15000 (4500 RPM); 50000 (4000RPM) max. Beladung / max. load: 1060 g						
		6322	4223	4232	4245-A	4215		
		 3)	 3)	 3)	 3)	 3)		
		Corning						
								
Kapazität / capacity	ml	250	8	15	50	30		
Maße / dimensions	Ø x L mm	60 x 162	16 x 125	17 x 120	29 x 115	25 x 110		
Anzahl p. Rotor / number p. rotor		4	100	92	32	44		
Drehzahl / speed	RPM	4500	4500	4500	4500	4500		
RZB / RCF	<sup>2)</sup>	4777	4777	4958	4958	4777		
Radius / radius	mm	211	211	219	219	211		
	9 (97%)					115		
	9					116		
Temperatur / temperature	°C <sup>1)</sup>					6		

4294		4298-A				4293		
<b>Ausschwingrotor 4-fach / Swing out rotor 4-times</b>  $\angle 90^\circ$ max. Laufzyklen / max. cycles 40000								
		max. Laufzyklen / max. cycles 50000 max. Beladung / max. load: 1150 g						
		4237-A				4244-A		
								
		1-fach/ 1-times	4-fach/ 4-times	4-fach/ 4-times	1-fach/ 1-times	3-fach/ 3-times	2-fach/ 2-times	3-fach/ 3-times
								
Kapazität / capacity	ml	1000	450	500	750	450	500	500
Maße / dimensions	Ø x L mm	---	---	---	---	---	---	---
Anzahl p. Rotor / number p. rotor		4	4	4	4	4	4	4
Drehzahl / speed	RPM	4500	4500	4500	4500	4500	4500	4500
RZB / RCF	<sup>2)</sup>	5071	5003	5003	5003	5252	5252	5252
Radius / radius	mm	224	221	221	221	232	232	232
	9 (97%)					115		
	9					116		
Temperatur / temperature	°C <sup>1)</sup>	3				2		

- |                                                                                                                                                                                                                     |                                                                                                                                                                                                                                   |
|---------------------------------------------------------------------------------------------------------------------------------------------------------------------------------------------------------------------|-----------------------------------------------------------------------------------------------------------------------------------------------------------------------------------------------------------------------------------|
| 1) Tiefste erreichbare Temperatur bei maximaler Drehzahl, 1 h Laufzeit und 20°C Raumtemperatur (nur bei Kühlzentrifuge)<br>2) Angaben des Röhrchenherstellers beachten.<br>3) nicht mit Deckel 4229-B verschließbar | 1) Lowest possible temperature during maximum speed, 1 h running time and 20°C ambient temperature (only with cooling centrifuges)<br>2) Observe the tube manufacturer's instructions.<br>3) not possible to close the lid 4229-B |
|---------------------------------------------------------------------------------------------------------------------------------------------------------------------------------------------------------------------|-----------------------------------------------------------------------------------------------------------------------------------------------------------------------------------------------------------------------------------|

<p><b>4294</b></p> <p><b>Ausschwingrotor 4-fach / Swing out rotor 4-times</b></p>  <p>∠ 90°</p> <p>max. Laufzyklen / max. cycles 40000</p>	<p><b>4280</b>      <b>5629</b></p> 		<p>max. Laufzyklen / max. cycles: 50000 max. Beladung / max. load: 690 g</p>								
	<p><b>4279</b></p> 						<p><b>4279 + 1485</b></p> 				
	MTP	MTP	CP	MS	DWP	QP	96-PCR- Platte / plate	PCR-Strips			
											
	Kapazität / capacity ml								0,2		
Maße / dimensions TxBxH / DxWxH mm		86 x 128 x 15	86 x 128 x 17,5	86 x 128 x 22	86 x 128 x 46	86 x 128 x 44,5	86x128x 83	82x124x20			
Anzahl p. Rotor / number p. rotor		24	24	20	4	8	4	4	48 x 8		
Drehzahl / speed RPM		4500	4500	4500	4500	4500	4500	4500	4500		
RZB / RCF <sup>2)</sup>		4573	4573	4573	4573	4573	4573	4573	4573		
Radius / radius mm		202	202	202	202	202	202	202	202		
 9 (97%) sec								115			
 g sec								116			
Temperatur / temperature °C <sup>1)</sup>								5			

1) Tiefste erreichbare Temperatur bei maximaler Drehzahl, 1 h Laufzeit und 20°C Raumtemperatur (nur bei Kühlzentrifuge)  
2) Angaben des Röhrchenherstellers beachten.

1) Lowest possible temperature during maximum speed, 1 h running time and 20°C ambient temperature (only with cooling centrifuges)  
2) Observe the tube manufacturer's instructions.











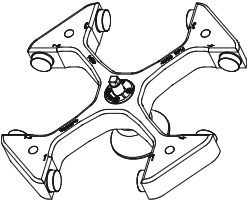

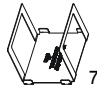

MTP Mikrotiterplatte /  
Microtitre plate



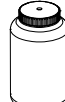







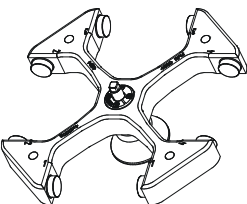

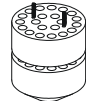
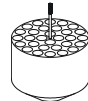
CP Kulturplatte /  
Culture plate

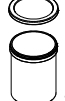
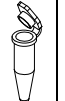
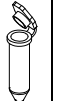
DWP Deep Well Platte /  
Deep well plate

MS Micronic System /  
Micronic system

QP Filterplatte /  
Filter plate











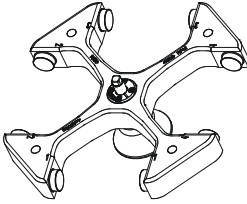



4294	4257	4254 + 4255 / 4255-P 8)								
<b>Ausschwingrotor 4-fach / Swing out rotor 4-times</b>  $\angle 90^\circ$  max. Laufzyklen / max. cycles 40000		 9)								
	max. Laufzyklen / max. cycles: 20000 max. Beladung / max. load: 800 g		max. Laufzyklen / max. cycles: 30000 max. Beladung / max. load: 800 g (4500 RPM), 1000 g (4020 RPM), 1200 g (3670 RPM)							
	4259-A					4449	4430			
	 7)									
Hitachi-Racks	0554	0512	4239	Corning	Corning	Nal-gene	Nunc			
	 12)	 12)	 12)							
Kapazität / capacity ml	650		750	1000	500	250	175	200		
Maße / dimensions $\varnothing \times L$ mm	20 x 118 x 70	20 x 118 x 70	97 x 139	97 x 152	96 x 176	96 x 147	60 x 162	61,5 x 144,3	60 x 130	
Anzahl p. Rotor / number p. rotor	20	20	4	4	4	4	4			
Drehzahl / speed RPM	4500	4500	4500	4500	4500	4500	4500			
RZB / RCF 2)	4822	4867	5184	5184	5184	5184	5184			
Radius / radius mm	213	215	229	229	229	229	229			
 9 (97%)					115					
 9					116					
Temperatur / temperature °C 1)	7				6					











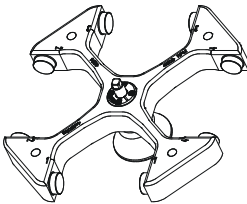

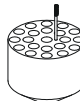
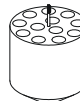
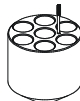
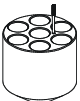
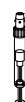
4294	4254	4254 + 4255 / 4255-P 8)								
<b>Ausschwingrotor 4-fach / Swing out rotor 4-times</b>  $\angle 90^\circ$  max. Laufzyklen / max. cycles 40000										
	max. Laufzyklen / max. cycles: 20000		max. Laufzyklen / max. cycles: 30000 max. Beladung / max. load: 800 g (4500 RPM), 1000 g (4020 RPM), 1200 g (3670 RPM)							
	4432					4433	4434			
										
4255 / 4255-P 8)										
 13)										
Kapazität / capacity ml	1000	1,5	2,0	5	7	2,7 - 3	4,5 - 5	9	10	
Maße / dimensions $\varnothing \times L$ mm	98 x 138	11 x 38		12 x 75	12 x 100	11 x 66	11 x 92	14 x 100	17 x 70	
Anzahl p. Rotor / number p. rotor	4	168		120	120	120	120	76	76	
Drehzahl / speed RPM	4500	4500		4500	4500	4500	4500	4500	4500	
RZB / RCF 2)	5184	3600/4686		4618	4618	4618	4618	4777	4777	
Radius / radius mm	229	159/207		204	204	204	204	211	211	
 9 (97%)					115					
 9					116					
Temperatur / temperature °C 1)					6					

- 1) Tiefste erreichbare Temperatur bei maximaler Drehzahl, 1 h Laufzeit und 20°C Raumtemperatur (nur bei Kühlzentrifuge)
- 2) Angaben des Röhrchenherstellers beachten.
- 7) Bei Verwendung von Entnahmehilfe 4259-A die Einlage (E2435) aus Gehänge 4257 herausnehmen. Entnahmehilfe 4259-A nur voll beladen zentrifugieren.
- 8) 4255-P: spezielle Oberflächenbehandlung für höchste hygienische Ansprüche
- 9) 4255 ohne Deckel
- 12) Bei Temperaturen über 40 °C und/oder geringer Befüllung der Gefäße können sich diese verformen.
- 13) Maximale Beladung 800g. Bei einer Beladung über 800g muss die Drehzahl reduziert werden, siehe Beschriftung auf dem Becher. Berechnung der reduzierten Drehzahl siehe Kapitel "Zentrifugation von Stoffen oder Stoffgemischen mit einer höheren Dichte als 1,2 kg/dm<sup>3</sup>".

- 1) Lowest possible temperature during maximum speed, 1 h running time and 20°C ambient temperature (only with cooling centrifuges)
- 2) Observe the tube manufacturer's instructions.
- 7) When using removal frame 4259-A please take insert (E2435) out of hanger 4257. Centrifuge removal frame 4259-A only when fully loaded.
- 8) 4255-P: special surface treatment for highest hygienic requirements
- 9) 4255 without lid
- 12) At temperatures above 40 °C and/or poor filling of the tubes, these can go out of shape.
- 13) Maximum load 800g. With a load higher than 800g the speed has to be reduced, see label on the bucket. Calculation of the reduced speed see chapter "Centrifugation of materials or mixtures of materials with a density higher than 1.2 kg/dm<sup>3</sup>".











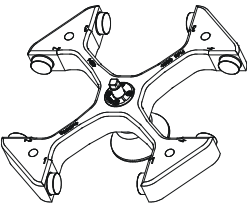

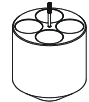

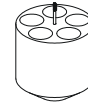
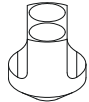

4294	4254 + 4255 / 4255-P 8)								
<b>Ausschwingrotor 4-fach / Swing out rotor 4-times</b>    max. Laufzyklen / max. cycles 40000									
	max. Laufzyklen / max. cycles: 30000				max. Laufzyklen / max. cycles: 30000 max. Beladung / max. load: 800 g (4500 RPM), 1000 g (4020 RPM), 1200 g (3670 RPM)				
	4434								
									
								 3)	
Kapazität / capacity	ml	15	10	8	4 – 5,5	9 - 10	4 - 7	8,5 - 10	10
Maße / dimensions	∅ x L	mm	17 x 100	16 x 80	16 x 81	15 x 75	16 x 92	16 x 75	16 x 102
Anzahl p. Rotor / number p. rotor		76	76	76	76	76	76	76	76
Drehzahl / speed	RPM	4500	4500	4500	4500	4500	4500	4500	4500
RZB / RCF	<sup>2)</sup>	4777	4777	4777	4777	4777	4777	4777	4777
Radius / radius	mm	211	211	211	211	211	211	211	211
 9 (97%)	sec							115	
 9	sec							116	
Temperatur / temperature	°C <sup>1)</sup>							6	

4294	4254 + 4255 / 4255-P 8)									
<b>Ausschwingrotor 4-fach / Swing out rotor 4-times</b>    max. Laufzyklen / max. cycles 40000										
	max. Laufzyklen / max. cycles: 30000				max. Laufzyklen / max. cycles: 30000 max. Beladung / max. load: 800 g (4500 RPM), 1000 g (4020 RPM), 1200 g (3670 RPM)					
	4435		4437		4438		4438 + 0726			
	   									
										
Kapazität / capacity	ml	2,6 – 3,4	4,9	1,6 - 5	4 – 7	15	25	30	25	
Maße / dimensions	∅ x L	mm	13 x 65	13 x 90	13 x 75	13 x 100	17 x 120	25 x 90	25 x 110	24 x 100
Anzahl p. Rotor / number p. rotor		84	84	84	84	48	28	28	28	
Drehzahl / speed	RPM	4500	4500	4500	4500	4500	4500	4500	4500	
RZB / RCF	<sup>2)</sup>	4618	4618	4618	4618	4890	4709	4709	4505	
Radius / radius	mm	204	204	204	204	216	208	208	199	
 9 (97%)	sec							115		
 9	sec							116		
Temperatur / temperature	°C <sup>1)</sup>							6		

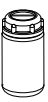









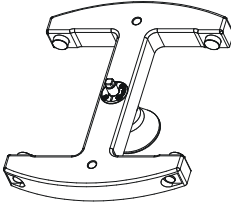
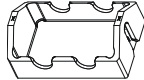

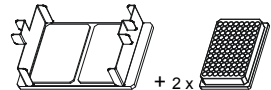
- 1) Tiefste erreichbare Temperatur bei maximaler Drehzahl, 1 h Laufzeit und 20°C Raumtemperatur (nur bei Kühlzentrifuge)
- 2) Angaben des Röhrchenherstellers beachten.
- 8) 4255-P: spezielle Oberflächenbehandlung für höchste hygienische Ansprüche
- 3) nicht mit Deckel verschließbar





- 1) Lowest possible temperature during maximum speed, 1 h running time and 20°C ambient temperature (only with cooling centrifuges)
- 2) Observe the tube manufacturer's instructions.
- 8) 4255-P: special surface treatment for highest hygienic requirements
- 3) not possible to close the lid

<b>4294</b>	<b>4254 + 4255 / 4255-P 8)</b>							
<p><b>Ausschwingrotor 4-fach / Swing out rotor 4-times</b></p>  <p style="text-align: center;">∠ 90°</p> <p>max. Laufzyklen / max. cycles 40000</p>	 				<p>max. Laufzyklen / max. cycles: 30000</p> <p>max. Laufzyklen / max. cycles: 30000 max. Beladung / max. load: 800 g (4500 RPM), 1000 g (4020 RPM), 1200 g (3670 RPM)</p>			
	4439	4440	4441	4442	4443			
								
		Falcon	Falcon			5127		
								
Kapazität / capacity ml	50	225	175	50	100	250	290	
Maße / dimensions Ø x L mm	34 x 100	61 x 137	61 x 118	29 x 115	44 x 100	62 x 122	62 x 137	
Anzahl p. Rotor / number p. rotor	16	4	4	20	8	4	4	
Drehzahl / speed RPM	4500	4500	4500	4500	4500	4500	4500	
RZB / RCF <sup>2)</sup>	4573	5184	5184	4890	4551	5003	5003	
Radius / radius mm	202	229	229	216	201	221	221	
 9 (97%) sec								115
 9 sec								116
Temperatur / temperature °C <sup>1)</sup>								6

- 1) Tiefste erreichbare Temperatur bei maximaler Drehzahl, 1 h Laufzeit und 20°C Raumtemperatur (nur bei Kühlzentrifuge)
- 2) Angaben des Röhrchenherstellers beachten.
- 3) nicht mit Deckel verschließbar
- 8) 4255-P: spezielle Oberflächenbehandlung für höchste hygienische Ansprüche
- 12) Bei Temperaturen über 40 °C und/oder geringer Befüllung der Gefäße können sich diese verformen.

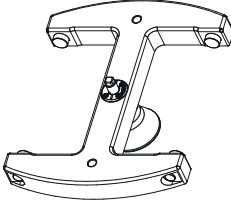
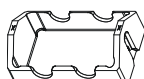
- 1) Lowest possible temperature during maximum speed, 1 h running time and 20°C ambient temperature (only with cooling centrifuges)
- 2) Observe the tube manufacturer's instructions.
- 3) not possible to close the lid
- 8) 4255-P: special surface treatment for highest hygienic requirements
- 12) At temperatures above 40 °C and/or poor filling of the tubes, these can go out of shape.

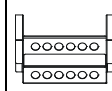
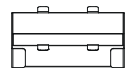
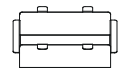
4282	4285-A						
<b>Ausschwingrotor 2-fach / Swing out rotor 2-times</b>    $\angle 90^\circ$  max. Laufzyklen / max. cycles 100000	  max. Laufzyklen / max. cycles: 12000 (3600 RPM), 30000 (3000 RPM) max. Beladung / max. load: 2320 g						
	4281 				4281 + 1485  + 2 x		
	MTP	CP	MTP	DWP	Microtest-platten / plate Terasaki	96-PCR-Platte / plate	PCR-Strips
							
Kapazität / capacity	ml						0,2
Maße / dimensions TxBxH / DxWxH	86x128x17,5	86x128x22	86x128x15	86x128x44,5	59x84x11	82x124x20	---
Anzahl p. Rotor / number p. rotor	16	12	16	4	4	4	48 x 4
Drehzahl / speed	RPM						
	3600	3600	3600	3600	3600	3600	3600
RZB / RCF	2)						
	2434	2434	2434	2434	2434	2434	2434
Radius / radius	mm						
	168	168	168	168	168	168	168
 9 (97%)	sec				87		
 9	sec				94		
Temperatur / temperature	°C <sup>1)</sup>						- 2

4282	4285-A				
<b>Ausschwingrotor 2-fach / Swing out rotor 2-times</b>    $\angle 90^\circ$  max. Laufzyklen / max. cycles 100000	  max. Laufzyklen / max. cycles: 12000 (3600 RPM), 30000 (3000 RPM) max. Beladung / max. load: 2320 g				
	4263-A	SK 01.14	4283-B	4287-B	4288-A
					
	S-Monovette®- Rack Sarstedt 50 Positionen/ positions	AutoMate™- Rack Beckman Coulter 50 Positionen/ positions	Olympus- Racks	Hitachi- Racks	Behring Rack
Kapazität / capacity	ml				
Maße / dimensions TxBxH / DxWxH	209x109x45	209x109x45	20 x 41 x 176	20 x 70 x 118	25 x 60 x 193
Anzahl p. Rotor / number p. rotor	2	2	12	20	10
Drehzahl / speed	RPM				
	3600	3600	3600	3600	3600
RZB / RCF	2)				
	2579	2579	2652	2652	2652
Radius / radius	mm				
	178	178	183	183	183
 9 (97%)	sec			87	
 9	sec			94	
Temperatur / temperature	°C <sup>1)</sup>				- 2

1) Tiefste erreichbare Temperatur bei maximaler Drehzahl, 1 h Laufzeit und 20°C Raumtemperatur (nur bei Kühlzentrifuge)  
 2) Angaben des Röhrchenherstellers beachten.

1) Lowest possible temperature during maximum speed, 1 h running time and 20°C ambient temperature (only with cooling centrifuges)  
 2) Observe the tube manufacturer's instructions.











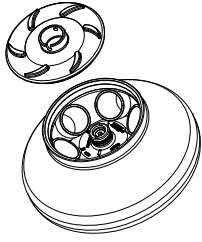





MTP Mikrotiterplatte /  
Microtitre plate

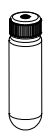

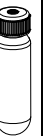

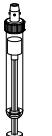





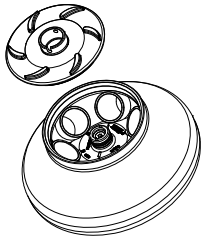

CP Kulturplatte /  
Culture plate

DWP Deep Well Platte /  
Deep well plate

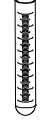
MS Micronic System /  
Micronic system

QP Filterplatte /  
Filter plate

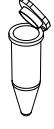
4246													
Winkelrotor 6-fach / Angle rotor 6-times		---		1454		1446		1447		1466		1451	
 45° mit Bioabdichtung / with bio-containment <sup>5)</sup> max. Laufzyklen / max. cycles 15000													
		14)											
													
Kapazität / capacity	ml	94	85	50	50	25	30	15	7,5 - 8,5	9 - 10			
Maße / dimensions	Ø x L	38 x 102	38 x 106	29 x 115	29 x 107	24 x 100	26 x 95	17 x 120	15 x 92	16 x 92			
Anzahl p. Rotor / number p. rotor		6		6	6	6		6	6	6			
Drehzahl / speed	RPM	11500		11500	11500	11500		11500	11500	11500			
RZB / RCF	<sup>2)</sup>	18038		17595	17299	16560		17299	17003	17003			
Radius / radius	mm	122		119	117	112		117	115	115			
 9 (97%)	sec							64					
 9	sec							64					
Temperatur / temperature	°C <sup>16)</sup>	4											

4246													
Winkelrotor 6-fach / Angle rotor 6-times		1451			1463			---		1448		1476	
 45° mit Bioabdichtung / with bio-containment <sup>5)</sup> max. Laufzyklen / max. cycles 15000													
													
Kapazität / capacity	ml	8,5 - 10		10	15	50	75	85	10	5			
Maße / dimensions	Ø x L	16 x 100		15 x 102	17 x 100	34 x 100	35 x 105	38 x 102	16 x 80	17 x 51			
Anzahl p. Rotor / number p. rotor		6		6	6	6	6	6	12	6			
Drehzahl / speed	RPM	11500		11500	11500	11500	11500	11500	11500	11500			
RZB / RCF	<sup>2)</sup>	17003		17003	17003	17743	17743	18038	17003	16856			
Radius / radius	mm	115		115	115	120	120	122	115	114			
 9 (97%)	sec							64					
 9	sec							64					
Temperatur / temperature	°C <sup>16)</sup>	4											

2) Angaben des Röhrchenherstellers beachten.

5) Nach DIN EN 61010, Teil 2 – 020. Die Hinweise für Bio-Sicherheitssysteme in den Kapiteln "Sicherheitshinweise" und "Pflege und Wartung" beachten.

14) Maße mit Deckel 38 x 110 mm





16) Niedrigste Probentemperatur bei Vorkühlung und maximaler Drehzahl





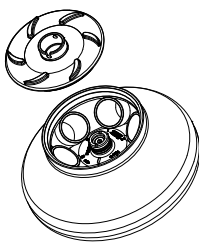
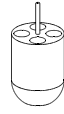

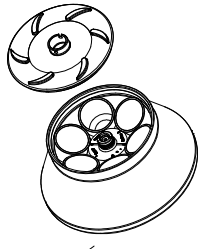
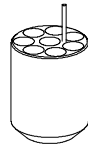
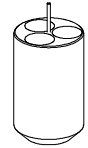
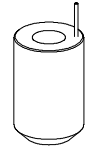
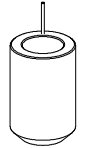
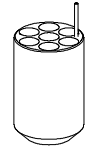
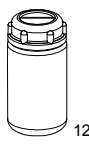

2) Observe the tube manufacturer's instructions.

5) In conformity with DIN EN 61010, part 2 – 020. Observe the notes for bio safety systems in chapters "Notes on safety" and "Maintenance and servicing".

14) Dimensions with cap 38 x 110 mm

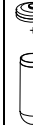
16) Lowest sample temperature with pre-cooling and maximum speed (only with cooling centrifuges)

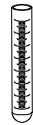
4246		1449		1403				
<b>Winkelrotor 6-fach / Angle rotor 6-times</b>  $\angle 45^\circ$ mit Bioabdichtung / with bio-containment <sup>5)</sup> max. Laufzyklen / max. cycles 15000								
Kapazität / capacity	ml	1,5	2,0	0,5	3	4		
Maße / dimensions	Ø x L mm	11 x 38	11 x 38	10,7 x 46	10 x 60	12 x 40		
Anzahl p. Rotor / number p. rotor		24	24	24	24	24		
Drehzahl / speed	RPM	11500			11500			
RZB / RCF	<sup>2)</sup>	17299			17003			
Radius / radius	mm	117			115			
 9 (97%)	sec	64			64			
 9	sec	64			64			
Temperatur / temperature	°C <sup>16)</sup>	4			4			

4266		---	5641	5642	5643	5644		5646		
<b>Winkelrotor 6-fach / Angle rotor 6-times</b>  $\angle 25^\circ$ mit Bioabdichtung / with bio-containment <sup>5)</sup> max. Laufzyklen / max. cycles 15000										
		5127					14)			
	 <sup>12)</sup>									
Kapazität / capacity	ml	250	10	30	25	50	94	85	85	15
Maße / dimensions	Ø x L mm	61 x 122	16 x 80	26 x 95	24 x 100	29 x 107	38 x 102	38 x 106	38 x 102	17 x 100
Anzahl p. Rotor / number p. rotor		6	48	18		6	6		6	42
Drehzahl / speed	RPM	9500	9500	9500		9500	9500		9500	9500
RZB / RCF	<sup>2)</sup>	14025	13420	12915		12108	12310		12310	13319
Radius / radius	mm	139	133	128		120	122		122	132
 9 (97%)	sec	82								
 9	sec	96								
Temperatur / temperature	°C <sup>16)</sup>	2								

2) Angaben des Röhrchenherstellers beachten.

5) Nach DIN EN 61010, Teil 2 – 020. Die Hinweise für Bio-Sicherheitssysteme in den Kapiteln "Sicherheitshinweise" und "Pflege und Wartung" beachten.

12) Bei Temperaturen über 40 °C und/oder geringer Befüllung der Gefäße können sich diese verformen.

14) Maße mit Deckel 38 x 110 mm

16) Niedrigste Proben temperatur bei Vorkühlung und maximaler Drehzahl (nur bei Kühlzentrifuge)

2) Observe the tube manufacturer's instructions.

5) In conformity with DIN EN 61010, part 2 – 020. Observe the notes for bio safety systems in chapters "Notes on safety" and "Maintenance and servicing".

15) At temperatures above 40 °C and/or poor filling of the tubes, these can go out of shape.

14) Dimensions with cap 38 x 110 mm

16) Lowest sample temperature with pre-cooling and maximum speed (only with cooling centrifuges)