

vortexer

Multi-purpose,
maximum convenience

Instruction Manual

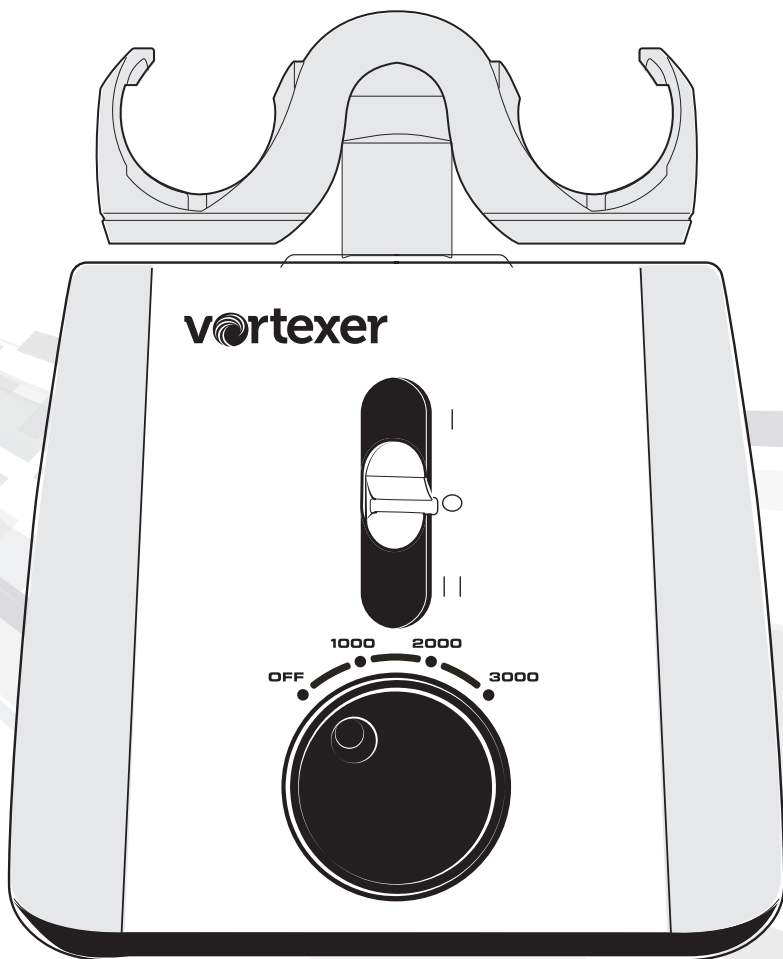

Instruction Manual.....	2
Manual de Instrucciones	12
Manuel d'instructions.....	23
Bedienungsanleitung	34



To immediately shut off power to Vortexer device, pull out the AC cord from the lower central back area of the device

Thank you for purchasing the Heathrow Scientific Vortexer. Your Vortexer mixing instrument is designed for general laboratory use

Safety Precautions

Your Vortexer instrument is designed for general laboratory use. This instruction manual cannot address all safety hazards. It is the responsibility of the user to consult and observe all health and safety precautions and to assess the instrument's suitability to perform the task.

Caution!

Before starting the Vortexer for the first time, please read this instruction manual carefully. This manual contains important information, safeguards, and operating instructions.

1. Never use this product in any manner inconsistent with these instructions.
2. This product is intended to be used indoors only.
3. This product is intended for vortexing and mixing solutions in approved test tubes compatible to the speed and power of this unit.
4. The product is not intended to vortex very dense materials. Do not use materials with a density greater than 1.2g/cm.
5. Observe general laboratory safety precautions and regulations when using this product.
6. Do not attempt to operate with the mixing head attachment removed. Vortexer may become destabilized in operation.
7. The mixing head attachment must always be securely fastened when in operation: Always make certain that the head attachment is seated completely onto the top shaft before operating.
8. Do not use if the Vortexer is damaged.
9. Do not put hands onto or under the mixing head attachment unless the Vortexer is completely stopped.
10. Do not move unit while the the Vortexer is in operation.
11. Do not immerse the product in water. Injury due to shock or fire may result.
12. The mixing head attachment must be loaded symmetrically. Operating this unit with an unbalanced load will cause severe vibration and damage, which is not covered by warranty.
13. Do not fill tubes while inserted onto the Vortexer mixing head. Spilled liquid may harm the unit or the user.
14. Close tube lids before starting the Vortexer instrument. Open tube lids can be torn off during vortexing and damage the unit. Open lids can cause fluid to be dispersed inside the vortex instrument.
15. Do not insert non-standard tubes or other foreign articles into the Vortexer head.
16. Follow all precautions from the Material Safety Data Sheet (MSDS) for any reagent you use with this instrument.
17. Do not use solvent or flammable liquids near this or other electrical equipment.
18. Do not vortex materials that in combination or alone are flammable, explosive, or corrosive or may cause any other hazard.

19. Do not operate in a hazardous or flammable environment.
20. Do not use any solvent on the unit that may degrade the plastic of the Vortexer main housing or head.
21. Ensure the mixing head is protected from corrosion and mechanical damage. The mixing head must be cleaned with a pH-neutral cleaning liquid.
22. Always work in a manner which endangers neither the user nor any other person.
23. Should the instrument fail to work to specification, immediately stop vortexing. Contact the authorized dealer or the manufacturer if trouble persists.
24. Do not attempt to make contact with the mixing head attachment while unit is running. Doing so may cause the unit to fail and will void the warranty.
25. Only use original manufacturer's mixing head attachment, AC adapters, and any other spare parts.
26. If unit is malfunctioning or needs to be returned, please contact either the authorized dealer or Heathrow Scientific® LLC .
27. Improper use of the Vortexer instrument will void the warranty. If there is a failure during the warranty period, contact Heathrow Scientific® LLC for warranty service.
28. Do not attempt to use units that have not been correctly installed or repaired.
29. Do not attempt to disassemble or modify this product.
30. Store at room temperature in a dry area. Do not expose to sunlight, moisture, or extreme temperatures for prolonged periods of time.
31. Before using any cleaning or decontamination methods please contact Heathrow Scientific® LLC to ensure that the proposed method will not damage the equipment. A pH-neutral cleaning liquid must be used.
32. Vortexer must be unplugged from electrical source before any cleaning or maintenance is performed.



To immediately shut off power to Vortexer device, pull out the AC cord from the lower central back area of the device

Attention: If main electrical power is interrupted, Vortexer device will immediately begin operating if 3-position switch has not been set to **OFF** position when power is restored.

If power is interrupted:

- 1) Unplug cord from back of device
- 2) Set Vortexer switch to **OFF**

Warning!

- If the unit is not used as recommended by the manufacturer, the overall safety will be impaired.
- Check MSDS, wear required Personal Protective Equipment, and observe all applicable local and national regulations before dispensing and disposing of hazardous samples.
- The laboratory procedure should ensure that no person or hazardous substances are present within a 12" (30cm) zone around the Vortexer instrument when operating.
- This product does not contain bio-seals as per IEC/EN/CSA 61010-2-20 and cannot provide any level of containment in case of a spill or release of toxic, radioactive, or pathogenic micro-organisms thus these materials are not recommended to be used in this product.

Specifications

Product Description/Features: Thank you for purchasing the Heathrow Scientific Vortexer.

This device is a compact laboratory Vortexer that has 4 pre-set positions with 3 speed controls (**OFF, 1000, 2000, and 3000 rpm**) and is capable of vortexing microplates and 6 different tube sizes with the convenience of a single mixing head attachment. The Vortexer product has enough flexibility to perform the standard tasks that a vortex mixer is required to perform, plus it has the ability to hold a variety of tubes, containers, and microplates all within one mixing head design.

Supplied Equipment:

- 1 ea. Vortexer
- 1 ea. AC power cord
- 1 ea. mixing head
- 3 additional elastic retention cords
- 3 additional central pads for intermittent mixing area

Technical Features:

Speed range:

From 1000 to 3000 rpm – shaking to vortexing

Operation:

4-position speed rotary control=

Off, 1000, 2000, 3000

3-position slider power switch =

TOP Position: Intermittent

CENTER Position: OFF

BOTTOM Position: Continuous ON

Compact footprint

6.75" W x 7.5" D x 6" Height of main unit. 7.75" Height with Mixing Head attached.

(171mm W x 190mm D x 197mm H)

8.66 lbs – total Vortexer weight with Mixing Head attached (3.93 kg)

Orbital Diameter: 3.7mm

Product has a Thermal Protection Device

Five Versions: Global power connectivity

Electrical:

US/North America: 120VAC (110V – 120V, 50-60 HZ, 55 Watts, 1.0 Amps)

Japan PSE Rated: 100VAC (100V – 110V, 50-60 Hz, 66 Watts, 1.3 Amps)

United Kingdom: 230V (220V – 240V, 50-60 Hz, 44 Watts, .4 Amps)

European: 230VAC (220V – 240V, 50-60 Hz, 44 Watts, .4 Amps)

Australian: 230VAC (220V – 240V, 50-60 Hz, 44 Watts, .4 Amps)

Weighted base with elastomeric feet to prevent movement and provide vibration dampening and stability while in operation.

Certified unit: SGS-US-C, CE, RoHS 2, PSE Certified Cord, and WEEE compliant



710213

Maintenance free

2 year limited warranty

Vortexer is classified as "Installation Category 2"

Environmental: Ambient Temperature 2°C - 40°C (35.6°F - 104°F), 95% Humidity max.

Relative humidity ≤ 80% non-condensing

Model power required amps

HS120209-USA -120V, 1.0 Amps

HS120318-Japan - 100V, 1.3 Amps

HS120212-EU - 230V, 0.5, .4 Amps

HS120214-UK - 230V, 0.5, .4 Amps

HS120210-AU - 230V, 0.5, .4 Amps

Model dimensions:

Weight: 8.66 lbs. (3.93 Kg)

Base Dimensions:

6.75" W x 7.5" D x 6" Height of main unit.

7.75" Height with Mixing Head attached.

(171mm W x 190mm D x 197mm H)

EC Declaration of Conformity

Manufacturer: Heathrow Scientific® LLC

Address: 620 Lakeview Parkway • Vernon Hills, IL 60061 USA

European Contact: Emergo, Europe

Molenstraat 15, 2513 BH, The Hague, The Netherlands

This unit has been constructed and conforms to the following:

Safety Standards:

IEC/EN61010-1:2010, 2nd Edition

IEC/EN61010-2-051, 2nd Edition

ANSI/UL Std. 61010-1:2012

CAN/CSA C22.6

WEEE

RoHS 2

Signed:



CEO, Jim Waldenberg

Note: Changes or modifications to the product not expressly approved by the manufacturer could void the user's authority to operate the equipment.

Note: This product has been tested and found to comply with the limits of a Class 1A digital device pursuant to Part 15 of the FCC rules. These limits are designed to provide reasonable protection against harmful interference when the product is operating in a commercial environment. The product generates, uses, and can radiate radio frequency energy and if not installed and used in accordance with the user's manual may cause harmful interference to radio communications. Operation of the product in a residential area is likely to cause interference in which case the user will be required to correct the interference.

Your Vortexer is supplied with a pop-on mixing head attachment and an AC power cord located in the top corrugated box insert **1** of the product packaging. After you fully unpack your Vortexer from the package and remove the protective plastic bag, install the mixing head attachment (check that it is right side up).

IMPORTANT: YOU MUST PULL OUT INNER FRONT SUPPORT CARD **3** BEFORE REMOVING YOUR HEATHROW SCIENTIFIC® VORTEXER. USE TWO HANDS TO GRASP THE UNIT WHEN LIFTING OUT OF THE BOX. **4**

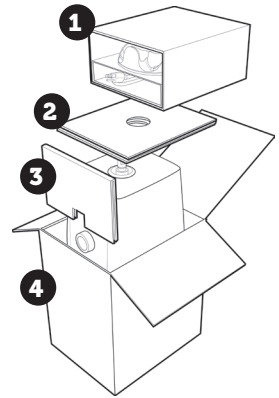

TO INSTALL THE MIXING HEAD ATTACHMENT YOU MUST PRESS DOWN FIRMLY WITH BOTH HANDS UNTIL YOU FEEL THE MIXING HEAD ATTACHMENT SNAP FULLY INTO PLACE.

This will ensure that the mixing head attachment will not come off the Vortexer during operation.

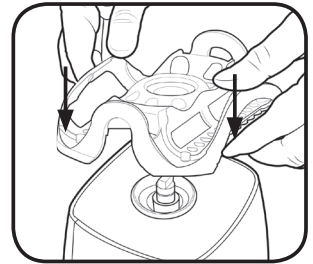

apply even pressure to ensure the head is secure

Place the Vortex Mixer on a level, stable surface near the grounded electrical outlet. The surface should be clean and free of dust to ensure that the feet grip the surface firmly. Allow sufficient clearance on all sides of the unit for proper ventilation and usage. With the power switch in the **OFF** position (central on the vertical 3-position), plug the power cord into the back of the Vortex Mixer. Have the speed rotary dial turned all the way to the left- (in the **OFF** position). Plug the device into a properly grounded outlet.

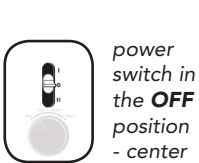

power switch in the **OFF** position - center

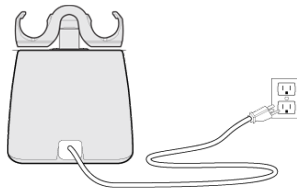

back view of Vortexer



To immediately shut off power to Vortexer device, pull out the AC cord from the lower central back area of the device

Modes of Operation:



WARNING:

110V-120V Vortexer: Recommended maximum run time of 60 minutes in Continuous Operation mode. If the Vortexer is used in a manner not specified by Heathrow Scientific, the protection provided by the equipment may be impaired.

100V-110V Vortexer: Recommended maximum run time of 45 minutes in Continuous Operation mode. If the Vortexer is used in a manner not specified by Heathrow Scientific, the protection provided by the equipment may be impaired.

The **speed control dial**, located in the lower center of the front panel, has 4-position adjustability (**OFF, 1000, 2000, and 3000rpm**). Vortexing speed increases at pre-set rates to a maximum of 3,000rpm as the knob is turned to the positions clockwise. Before turning on the Vortexer, set the speed dial to **OFF** position (rotate counter-clockwise until the knob stops). To begin operation, move the power switch to either the Intermittent **TOUCH** or **ON** position and turn the speed control to the desired setting. If the power switch is in the **ON** position, the mixing head will begin moving immediately. If the power switch is in the Intermittent **TOUCH** position, operation will begin when the 4-speed dial is set to **3000rpm** and an object (test tube) is placed in the center of the mixing head, held at the top of the test tube, and moderate pressure is applied to push down the mixing head. Mixing will cease when the object is removed and pressure is released.

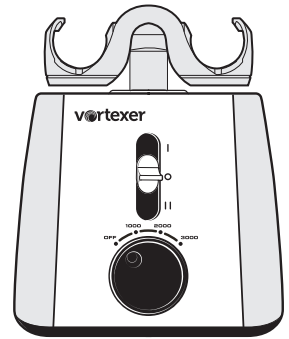

I - Intermittent - Top position
II - Continuous - Bottom position

Intermittent/touch mode:

Place the 3-position switch in the Top Intermittent **TOUCH** position and set the speed control round marker on the dial face to 3000rpm, turned all the way to the far right position of the dial. When pressure is released from the mixing head, operation will stop. Intermittent operation will begin when a test tube is pressed down in the center area of the mixing head, while the tube is held firmly at the top.

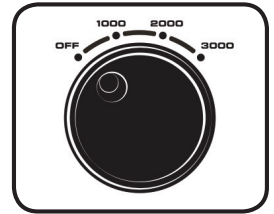

Hands free/continuous on mode:

Place the 3-position switch in the **ON** (bottom) position and set the speed control to any as described above. Hands Free mode allows mixing or vortexing of the tubes or microplate and will continue to run until you stop the mixer by placing the 3-position switch to the **OFF** position.

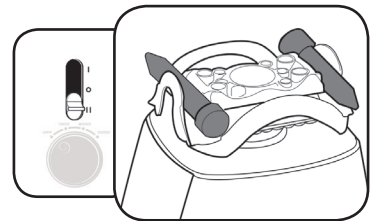
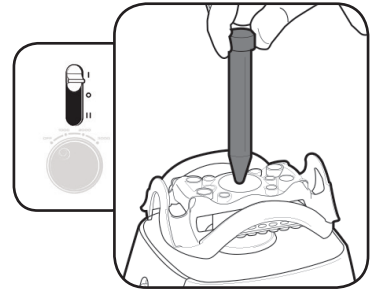

Note: If the Vortexer overheats during continuous use, there is a Temperature Protection Device internally that will temporarily shut off the device. Once the device cools down, it will be operational again. Please set switch to **OFF** position whenever it is not in operation.

Attention: It is recommended to **NOT** leave the Vortexer unattended while in operation.

OFF mode:

Always place the 3-position switch to the **OFF** position (center) when not in use!



Loading Tubes

The Vortexer mixing head is designed to hold several different tube sizes for hands-free mixing/vortexing.

Caution: Always load onto mixing head so that the tubes are balanced

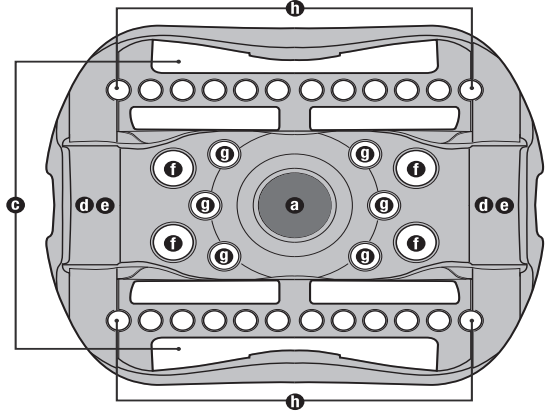

B. Loading of Standard Assay tray (maximum of 1)

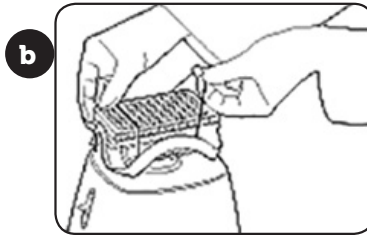

with supplied elastic retention cord secure Assay tray with supplied elastic cord pre-attached to mixing head

C. Loading of 50ml tubes (maximum of 2)

Note: Two retention cords should be used to secure 50 mL tubes

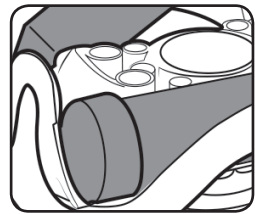
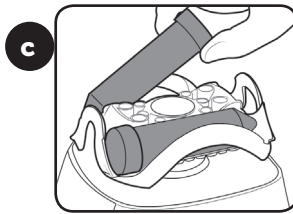

50 mL tube caps nest securely in debossed area of head

D. Loading of 15 mL tubes (maximum of 2)

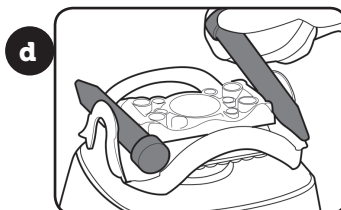

E. Loading of 5 mL tubes
(maximum of 2)

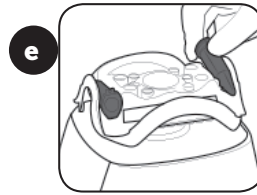

F. Loading of 1.5/2 mL tubes
(maximum of 4)

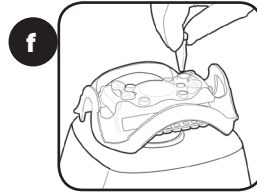

G. Loading of .5 mL tubes
(maximum of 6)

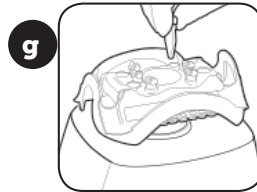

H. Loading of .2 mL tubes
(2 tube strips - maximum of 24)

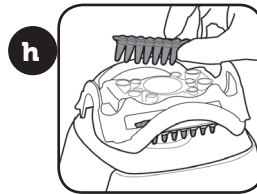

Vortexer head removal

In the event of a cleaning being needed for the Vortexer, please follow the sequence of removal for the mixing head.

Turn the power **OFF** by placing the 3-position switch into the **OFF** (center) position.

Grasp the installed mixing head attachment with two hands and pull straight up until it releases from the shaft. A technique of lifting the attachment with your finger tips while using your knuckles as a fulcrum will give you the leverage to remove the installed attachment component smoothly. Once Vortexer is cleaned, reinstall the mixing head per instructions.

place
switch in
the **OFF**
position

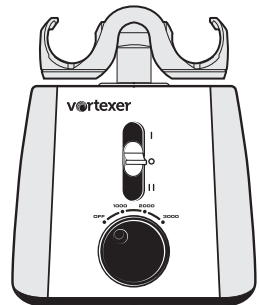

pull
straight
up

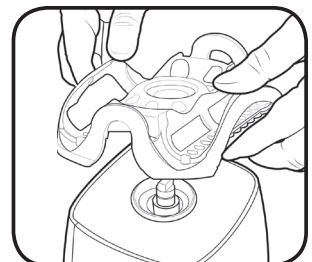

Care and Handling

Your Vortexer should be given the care normally required for any electrical appliance. Avoid wetting or unnecessary exposure to fumes. The finish can be washed with water (after unplugging) and mild soap or detergents, using a soft cloth or sponge. Avoid exposing any electrical components of the Vortexer instrument to water, cleaning agents, or other liquid! Keep the unit clean by immediately blotting any spills. Replacement parts are available through most laboratory equipment distributors or directly from Heathrow Scientific, LLC.

CAUTION! Unplug from power before cleaning. Do not immerse. Avoid getting any liquid into the Vortexer housing.

Parts assembly list

To order parts for the Vortexer:

Contact your local distributor or visit www.heathrowscientific.com.

Please specify Part No., quantity and electric voltage.

Part Numbers and Part Names:

HS120327 – **Mixing Head Attachment**

HS120328 – **Central Intermittent Vortexing Pad**

HS120422 – **3 additional elastic retention cords**

HS120329 – **120V Power Cord with USA UL Plug**

HS120330 – **100V Power Cord with Japan PSE Rated Plug**

HS120331 – **230V Power Cord with UK Rated Plug**

HS120332 – **230V Power Cord with European Rated Plug**

HS120333 – **230V Power Cord with Australian Rated Plug**

Disposal Responsibilities:

The equipment you purchased may contain hazardous substances that could impact the environment. Per regulations on electronic devices in the European Community, you must use the appropriate disposal systems to avoid exposure of these substances to the environment. The disposal systems will reuse or recycle hazardous materials from your equipment responsibly.



The crossed-out wheeled bin symbol invites you to use those systems.

If you need more information on the collection, reuse and recycling systems, please contact your local or regional waste administration. You can also contact us for more information on the environmental performance of our products.

Product Return Information

Important:

Transporting hazardous materials without a permit is a violation of federal law.

Heathrow Scientific® LLC will not accept any product return that is not appropriately cleaned and decontaminated. In the unlikely event of damage to the unit necessitates return, contact Heathrow Scientific® LLC and obtain return authorization before sending your product for service.

Warranty

IN NO EVENT WILL HEATHROW SCIENTIFIC® LLC'S OBLIGATION UNDER THIS WARRANTY EXCEED THE PRICE OF THE PRODUCT.

Limited Warranty

Heathrow Scientific® LLC warrants that Vortexer will be free from defects in workmanship and material for 2 years from the date of purchase.

If you believe that there is a defect in the product, you must, during the warranty period, notify Heathrow Scientific® LLC, provide proof of purchase, and return the product to Heathrow Scientific® LLC with a Return Authorization form. To obtain a Return Authorization form, please call 1-847-816-5070.

If Heathrow Scientific® LLC is properly notified and, after inspection, confirms that there is a defect and the warranty period has not expired, Heathrow Scientific® LLC will repair, modify, or replace the product, at its sole option, at no charge.

OTHER THAN THIS LIMITED WARRANTY, HEATHROW SCIENTIFIC® LLC MAKES NO WARRANTIES, EXPRESS OR IMPLIED, WITH RESPECT TO THE QUALITY OR PERFORMANCE OF THE PRODUCT, INCLUDING BUT NOT LIMITED TO THE IMPLIED WARRANTIES OF MERCHANTABILITY AND FITNESS FOR PARTICULAR PURPOSE WHICH ARE HEREBY DISCLAIMED AND EXCLUDED. HEATHROW SCIENTIFIC® LLC WILL IN NO EVENT BE LIABLE FOR ANY LOSS OF USE, LOSS OF PROFITS, CONSEQUENTIAL, SPECIAL, EXEMPLARY OR PUNITIVE DAMAGES.

THIS WARRANTY DOES NOT COVER:

ANY DEFECT OR DAMAGE CAUSED BY IMPROPER OR UNREASONABLE USE OF THE PRODUCT. (HEATHROW SCIENTIFIC® LLC VORTEXER IS DESIGNED FOR USE ONLY BY TRAINED LABORATORY TECHNICIANS. USE BY ANYONE ELSE WILL VOID THIS WARRANTY.)

ANY PRODUCT THAT HAS BEEN, IN HEATHROW SCIENTIFIC® LLC'S SOLE JUDGEMENT, TAMPERED WITH, ALTERED, OR REPAIRED BY ANYONE OTHER THAN HEATHROW SCIENTIFIC® LLC.

ANY PRODUCT THAT IS INOPERATIVE BECAUSE OF: (a) WEAR OCCASIONED BY USE, (b) NEGLIGENCE, (c) ACCIDENT, (d) INCORRECT MAINTENANCE, OR (e) USE UNDER ABNORMAL CONDITIONS OF TEMPERATURE, DIRT OR CORROSION, OR USE WITH ABRASIVE OR CORROSIVE MATERIALS.

ACCESSORY PARTS, SUCH AS RUBBER AND PLASTIC PARTS THAT ARE DAMAGED BY LIQUIDS OR MISUSE.