

## Instruction Manual

---

# HI 96832

## Propylene Glycol Refractometer

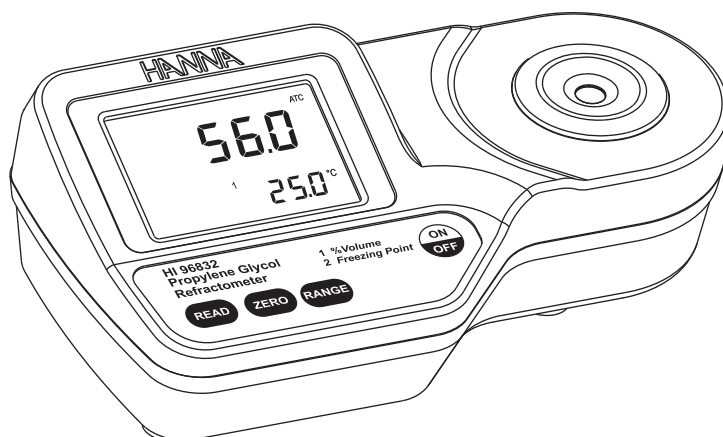

Dear Customer,

Thank you for choosing a Hanna product. This manual will provide you with the necessary information for the correct use of this instrument. Please read it carefully before using the meter. If you need additional technical information, do not hesitate to e-mail us at [tech@hannainst.com](mailto:tech@hannainst.com).

## TABLE OF CONTENTS

PRELIMINARY EXAMINATION .....	2
GENERAL DESCRIPTION .....	3
SPECIFICATIONS .....	3
PRINCIPLE OF OPERATION .....	4
MEASUREMENT UNITS .....	5
FUNCTIONAL DESCRIPTION .....	5
DISPLAY ELEMENTS .....	6
MEASUREMENT GUIDELINES .....	7
CALIBRATION PROCEDURE .....	7
MEASUREMENT PROCEDURE .....	8
TO CHANGE MEASUREMENT UNIT .....	9
TO CHANGE TEMPERATURE UNIT .....	9
MAKING A STANDARD SOLUTION .....	10
BATTERY REPLACEMENT .....	10
WARRANTY .....	10
ERROR MESSAGES .....	11

## PRELIMINARY EXAMINATION

Remove the instrument from the packing materials and examine carefully to ensure no damage has occurred during shipping. If any damage has occurred, notify your Dealer or closest Hanna Customer Service Center.

Each instrument is supplied with:

- 9 V battery
- Instruction manual

**Note:** Save all packing material until you are sure that the instrument functions correctly. A defective instrument must be returned in its original packing.

*All rights are reserved. Reproduction in whole or in part is prohibited without the written consent of the copyright owner, Hanna Instruments Inc., Woonsocket, Rhode Island, 02895, USA.*

## GENERAL DESCRIPTION

The **HI 96832** Digital Refractometer is a rugged portable, water resistant device that utilizes the measurement of refractive index to determine the % volume and freezing point of propylene glycol based solutions.

Propylene glycol is used in many applications including:

- pharmaceutical solvent
- humectant food additive
- emulsification agent
- moisturizer in cosmetics, toothpaste, tobacco products, etc.
- hand sanitizer and lotion
- antifreeze

The **HI 96832** device benefits from Hanna's years of experience as a manufacturer of analytical instruments. The digital refractometer eliminates the uncertainty associated with mechanical refractometers and is easily portable for use in the field.

The **HI 96832** refractometer is an optical device that is simple and quick to use. Samples are measured after a simple user calibration with distilled or deionized water. Within seconds, the refractive index and temperature are measured and converted into one of two measurement units; % Volume or Freezing Point. The instrument utilizes internationally recognized references for unit conversion and temperature compensation for propylene glycol solutions (e.g. CRC Handbook of Chemistry and Physics, 87<sup>th</sup> Edition).

The temperature (in °C or °F) is also displayed on the large dual level display along with helpful message codes.

Key features include:

- IP65 waterproof protection
- Automatic Temperature Compensation (ATC)
- Battery operation with Low Power indicator (BEPS)
- Automatically turns off after 3 minutes of non-use

## SPECIFICATIONS

	% Volume	Freezing Point	°C (°F)
<b>Range:</b>	0 to 100 %	0 to -51 °C (32 to -59.8 °F)	0 to 80 °C (32 to 176 °F)
<b>Resolution:</b>	0.1 %	0.1 °C (0.1 °F)	0.1 °C (0.1 °F)
<b>Accuracy:</b>	±0.3 %	±0.5 °C (±1.0 °F)	±0.3 °C (±0.5 °F)

Temperature Compensation:

Automatic between 0 and 40 °C (32 - 104 °F)

Measurement Time:

Approximately 1.5 seconds

Minimum Sample Volume:

100 µL (cover prism totally)

Light Source:

Yellow LED

Sample Cell:

Stainless Steel ring and flint glass prism

Case Material:

ABS

Enclosure Rating:

IP 65

Battery Type / Life:	1 X 9V / 5000 readings
Auto-Off:	After 3 minutes of non-use
Dimensions:	19.2(W) x 10.2(D) x 6.7(H) cm
Mass:	420 g

## PRINCIPLE OF OPERATION

Propylene Glycol determinations are made by measuring the refractive index of a solution. Refractive Index is an optical characteristic of a substance and the number of dissolved particles in it. Refractive Index is defined as the ratio of the speed of light in empty space to the speed of light in the substance. A result of this property is that light will “bend”, or change direction, when it travels through a substance of different refractive index. This is called refraction.

When passing from a material with a higher to lower refractive index, there is a critical angle at which an incoming beam of light can no longer refract, but will instead be reflected off the interface.

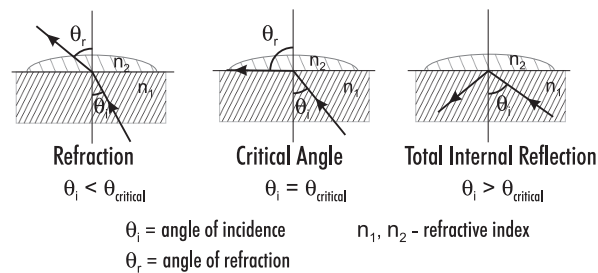

The critical angle can be used to easily calculate the refractive index according to the equation:

$$\sin(\theta_{critical}) = n_2 / n_1$$

Where  $n_2$  is the refractive index of the lower-density medium;  $n_1$  is the refractive index of the higher-density medium.

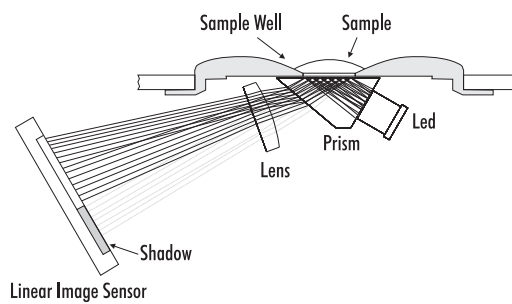

In the HI 96832 refractometer, light from an LED passes through a prism in contact with the sample. An image sensor determines the critical angle at which the light is no longer refracted through the sample. Specialized algorithms then apply temperature compensation to the measurement and convert the refractive index to: % Volume or Freezing Point.

## MEASUREMENT UNITS

Freezing point is displayed as a temperature from 0.0 to -51.0 °C corresponding to 0-60 % by volume.

When the display shows "LO", the freezing point is at a minimum (below -51 °C).

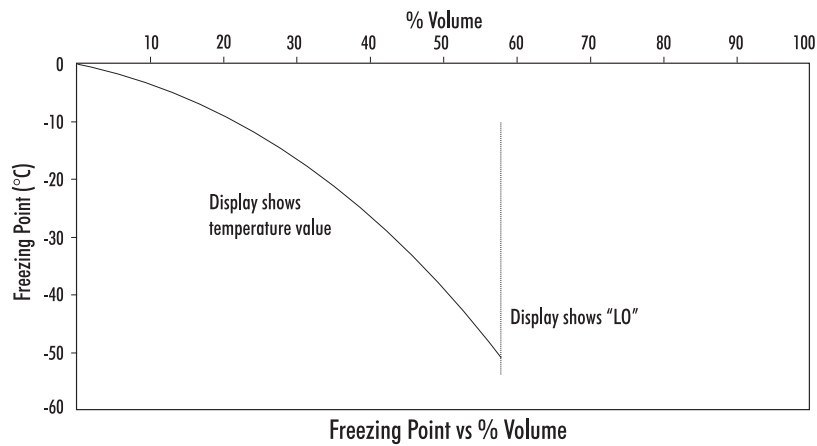

## FUNCTIONAL DESCRIPTION

TOP VIEW

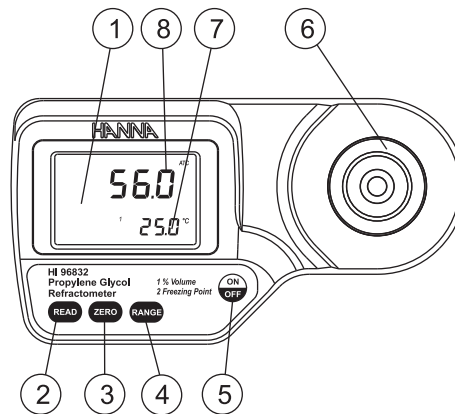

1. Liquid Crystal Display (LCD)
2. READ Key (User Measurement)
3. ZERO Key (User Calibration)
4. RANGE Key (User Measurement Unit)
5. ON/OFF
6. Stainless Steel Sample Well and Prism
7. Secondary Display
8. Primary Display

## BOTTOM VIEW

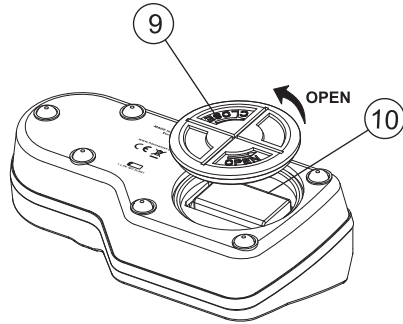

- 9. Battery Cover
- 10. Battery Compartment

## DISPLAY ELEMENTS

---

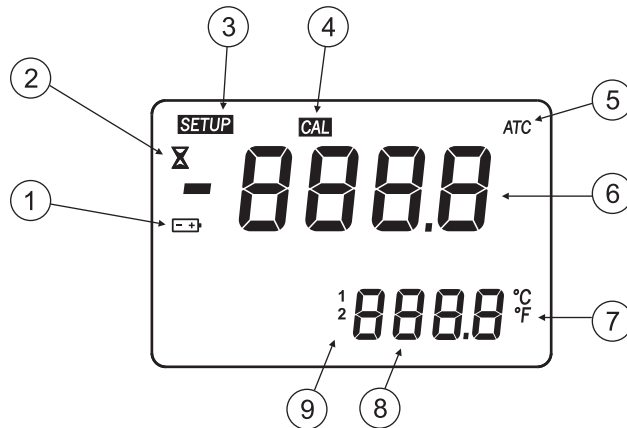

- 1. Battery (blinks when low battery condition detected)
- 2. Measurement in Progress Tag
- 3. SETUP: Factory Calibration Tag
- 4. CAL: Calibration Tag
- 5. Automatic Temperature Compensation  
(blinks when temperature exceeds 0-40°C / 32-104°F range)
- 6. Primary Display (displays measurement and error messages)
- 7. Temperature Units
- 8. Secondary Display (displays temperature measurements; when blinking, temperature has exceeded operation range: 0-80°C / 32-176°F)
- 9. Range indicator

## MEASUREMENT GUIDELINES

---

- Handle instrument carefully. Do not drop.
- Do not immerse instrument under water.
- Do not spray water to any part of instrument except the “sample well” located over the prism.
- The instrument is intended to measure propylene glycol solutions. Do not expose instrument or prism to solvents that will damage it. This includes most organic solvents and extremely hot or cold solutions.
- Particulate matter in a sample may scratch the prism. Absorb sample with a soft tissue and rinse sample well with deionized or distilled water between samples.
- Use plastic pipettes to transfer all solutions. Do not use metallic tools such as needles, spoons or tweezers as these will scratch the prism.
- Cover sample well with hand if measuring in direct sun.
- To reduce the effects of evaporation or absorption of water when taking readings over a period of time, the prism and sample well can be covered with plastic wrap.

## CALIBRATION PROCEDURE

---

Calibration should be performed daily, before measurements are made, when the battery has been replaced, between a long series of measurements, or if environmental changes have occurred since the last calibration.

1. Press the **ON/OFF** key, then release. Two instrument test screens will be displayed briefly; all LCD segments followed by the percentage of remaining battery life. The meter will then briefly display an indication of the measurement unit set. When the LCD displays dashes, the instrument is ready.

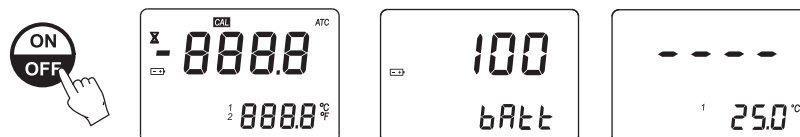

2. Using a plastic pipette, fill the sample well with distilled or deionized water. Make sure the prism is completely covered.

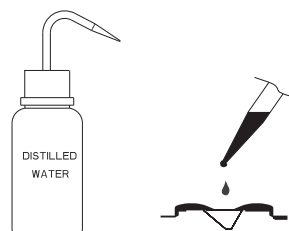

**Note:** If the ZERO sample is subject to intense light such as sunlight or another strong source, cover the sample well with your hand or other shade during the calibration.

3. Press the **ZERO** key. If no error messages appear, your unit is calibrated.  
(For a description of **ERROR MESSAGES** see page 11).



**Note:** The 0.0 screen will remain until a sample is measured or the instrument is turned off.

4. Gently absorb the ZERO water standard with a soft tissue. Use care not to scratch the prism surface. Dry the surface completely. The instrument is ready for sample measurement.



**Note:** If the instrument is turned off the calibration will not be lost.

## MEASUREMENT PROCEDURE

Verify the instrument has been calibrated before taking measurements.

1. Wipe off prism surface located at the bottom of the sample well. Make sure the prism and sample well are completely dry.



2. Using a plastic pipette, drip sample onto the prism surface. Fill the well completely.



**Note:** If the temperature of the sample differs significantly from the temperature of the instrument, wait approximately 1 minute to allow thermal equilibration.

3. Press the **READ** key. The results are displayed as % Volume or Freezing Point.

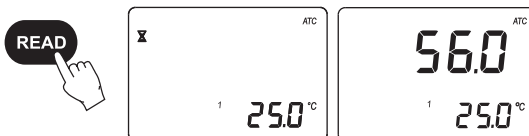

**Note:** The last measurement value will be displayed until the next sample is measured or the instrument is turned off. Temperature will be continuously updated.

**Note:** The "ATC" tag blinks and automatic temperature compensation is disabled if the temperature exceeds the 0-40 °C / 32-104 °F range.



- Remove sample from the sample well by absorbing with a soft tissue.
- Using a plastic pipette, rinse prism and sample well with distilled or deionized water. Wipe dry. The instrument is ready for the next sample.

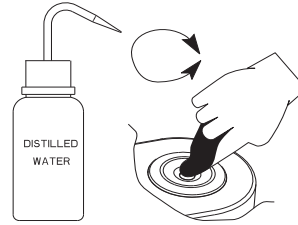

## TO CHANGE MEASUREMENT UNIT

Press the **RANGE** key to select the measurement units. The instrument toggles between the two measurement scales each time the key is pressed and the primary display indicates "Vol" % Volume or "FrPt" for Freezing Point. When the instrument displays the screen with 4 dashes, the instrument is ready for measurement. A number on the display indicates the selected unit: "1" denotes % Volume and "2" denotes Freezing Point (as indicated on the instrument cover).

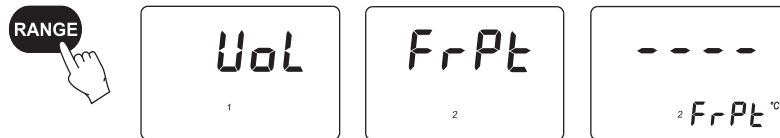

**Note:** The temperature measurement is not displayed in Freezing Point mode.

## TO CHANGE TEMPERATURE UNIT

To change the temperature measurement unit from Celsius to Fahrenheit (or vice versa), follow this procedure.

- Press and hold the **ON/OFF** key continuously for approximately 8 seconds. The LCD will display the "all segment" screen followed by a screen with the model number on the primary display and the version number on the secondary display. Continue pressing the **ON/OFF** key.



8 seconds

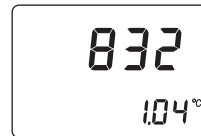

- While continuing to hold the **ON/OFF** key, press the **ZERO** key. The temperature unit will change from °C to °F or vice versa.

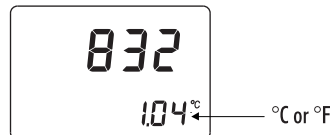

**Note:** The selected unit will be used in Freezing Point mode.

## MAKING A STANDARD SOLUTION

---

To make a Propylene Glycol Solution, follow the procedure below:

- To make an X % propylene glycol solution volumetrically add X mL of high purity propylene glycol (CAS #: 57-55-2; MW 76.09) to a 100 mL Grade A volumetric flask.
- Use distilled or deionized water to bring the flask close to the total volume, mix, allow the solution to return to room temperature.
- Once the solution has returned to room temperature use distilled or deionized water to bring the total volume to 100 mL. Mix solution well before use.

	Propylene Glycol	Total Volume	Expected Freezing Point Value
10 % V	10.00 mL	100.00 mL	-3.4 °C (25.9 °F)
40 % V	40.00 mL	100.00 mL	-21.3 °C (-6.3 °F)

## BATTERY REPLACEMENT

---

To replace the instrument's battery, follow these steps:

- Make sure the instrument is off. 
- Turn instrument upside down and remove the battery cover by turning it counterclockwise.

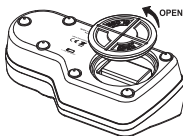

- Extract the battery from its location.
- Replace with a new 9V battery making sure to observe polarity.
- Insert the back battery cover and fasten it by turning clockwise to engage.

## WARRANTY

---

The **HI 96832** is warranted for two years against defects in workmanship and materials when used for its intended purpose and maintained according to the instructions.









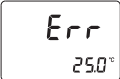

This warranty is limited to repair or replacement free of charge.

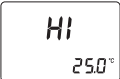
Damage due to accidents, misuse, tampering or lack of prescribed maintenance is not covered. If service is required, contact your dealer. If under warranty, report the model number, date of purchase, serial number and the nature of the failure. If the repair is not covered by the warranty, you will be notified of the charges incurred.

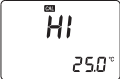
If the instrument is to be returned to Hanna Instruments, first obtain a Returned Goods Authorization Number from the Customer Service Department and then send it with shipment costs prepaid. When shipping any instrument, make sure it is properly packaged for complete protection.

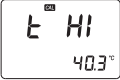
To validate your warranty, fill out and return the enclosed warranty card within 14 days from the date of purchase.

## ERROR MESSAGES

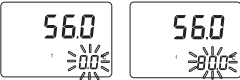
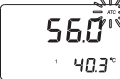
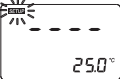
Error Code	LCD	Description
"Err"		General failure. Cycle power to instrument. If error persists, contact Hanna.
"LO" Primary display		Sample exceeds minimum measurement range.
"HI" Primary display		Sample exceeds maximum measurement range.
"LO" Primary display "CAL" segment ON		Wrong solution used to zero instrument. Use deionized or distilled water. Press ZERO.
"HI" Primary display "CAL" segment ON		Wrong solution used to zero instrument. Use deionized or distilled water. Press ZERO.
"t LO" Primary display "CAL" segment ON		Temperature exceeds ATC low limit (0 °C) during calibration.
"t HI" Primary display "CAL" segment ON		Temperature exceeds ATC high limit (40 °C) during calibration.
"Air"		Prism surface insufficiently covered.
"ELt"		Too much external light for measurement. Cover sample well with hand.
"nLt"		LED light is not detected. Contact Hanna.
Battery segment blinking		<5 % of battery life is remaining.
Temperature values are blinking "0.0°C" or "80.0°C"		Temperature measurement out of range (0 to 80°C).
"ATC" segment blinking		Outside temperature compensation range (0 to 40°C).
"SETUP" segment blinking		Factory calibration lost. Contact Hanna.



**Hanna Instruments Inc.**  
Highland Industrial Park  
584 Park East Drive  
Woonsocket, RI 02895 USA

**Technical Support for Customers**  
Tel. (800) 426 6287  
Fax (401) 765 7575  
E-mail [tech@hannainst.com](mailto:tech@hannainst.com)  
[www.hannainst.com](http://www.hannainst.com)

**Local Sales and Customer Service Office**

