

Instruction Manual

HI 847492

Portable Haze Meter

ASBC compliant



Dear Customer,

Thank you for choosing a Hanna Instruments product. This manual will provide you with the necessary information for correct use of the instrument.

Please read this instruction manual carefully before using the instrument.

If you need additional technical information, do not hesitate to e-mail us at tech@hannainst.com or see the back side of this manual for our worldwide sales and technical service contacts.

This instrument is in compliance with **CE** directives.

TABLE OF CONTENTS

| | |
|--|----|
| WARRANTY | 3 |
| PRELIMINARY EXAMINATION | 3 |
| GENERAL DESCRIPTION | 4 |
| ABBREVIATIONS | 5 |
| PRINCIPLE OF OPERATION | 6 |
| MEASUREMENT UNITS | 6 |
| SPECIFICATIONS | 7 |
| FUNCTIONAL DESCRIPTION | 8 |
| GENERAL TIPS FOR AN ACCURATE MEASUREMENT | 10 |
| CALIBRATION PROCEDURE | 11 |
| HAZE MEASUREMENT | 14 |
| LOGGING | 16 |
| GOOD LABORATORY PRACTICE (GLP) | 19 |
| SETUP | 20 |
| LCD BACKLIGHT | 24 |
| TAG INSTALLATION | 24 |
| BATTERY MANAGEMENT | 25 |
| ERROR CODES | 26 |
| PC INTERFACE | 26 |
| ACCESSORIES | 27 |

WARRANTY

HI 847492 is warranted for two years against defects in workmanship and materials when used for its intended purpose and maintained according to instructions. This warranty is limited to repair or replacement free of charge.

Damage due to accidents, misuse, tampering or lack of prescribed maintenance is not covered.

If service is required, contact the dealer from whom you purchased the instrument. If under warranty, report the model number, date of purchase, serial number and the nature of the failure. If the repair is not covered by the warranty, you will be notified of the charges incurred. If the instrument is to be returned to Hanna Instruments, first obtain a Returned Goods Authorization number from the Technical Service Department and then send it with shipping costs prepaid. When shipping any instrument, make sure it is properly packed for complete protection.

To validate your warranty, fill out and return the enclosed warranty card within 14 days from the date of purchase.

PRELIMINARY EXAMINATION

Please examine this product carefully. Make sure the instrument is not damaged. If any damage has occurred during the shipment, please notify your dealer.

This HI 847492 Portable Haze Meter is supplied complete with:

- One HI 98501-1 Checktemp thermometer
- Checktemp instruction manual
- Five Sample Cuvets and Caps
- Four Calibration Cuvets (HI 847492-11)
- Five Tag Holders with Tags (HI 920005)
- Cloth for wiping the cuvetts
- Silicon oil
- Four 1.5V AA Batteries
- AC Adapter
- Instruction Manual
- Instrument Quality Certificate
- Rigid carrying case

Note: Save all packing material until you are sure that the instrument works correctly. Any defective item must be returned in the original packing with the supplied accessories.

GENERAL DESCRIPTION

The **HI 847492** is an auto diagnostic microprocessor meter that benefits from Hanna's years of experience as manufacturer of analytical instruments.

The **HI 847492** is a ASBC (American Society of Brewing Chemists) compliant haze meter that is part of the new **HI 84749x** series, especially designed for haze measurements. The other models included are: **HI 847491** ISO compliant haze meter and **HI 847493** MEBAK compliant haze meter.

The optical system, consisting of a 580 nm LED and multiple detectors, assures low power consumption, long term stability and minimizes the need of frequent calibration. Calibration can be easily performed at any time in two, three or four adjustable points (<0.1, 15, 100 and 800 FTU), using the supplied or user prepared standards.

The meter has all necessary GLP (Good Laboratory Practice) functions to allow maximum traceability of data like a real time clock, log-on-demand (up to 200 measurements), and T.I.S. -Tag Identification System to give all recorded data a location, time and date stamp.

The meter measures haze of samples from 0.00 to 1000 FTU (Formazin Turbidity Units) . It has a continuous measurement mode to verify the settling rate of suspended matter, and a signal average (AVG) mode to accumulate multiple readings giving a final average value. The AVG setting is particularly useful to measure samples with suspended particles with different dimensions.

The **HI 847492** has a user-friendly interface, with a large backlit LCD (Liquid Crystal Display). Acoustic signals and displayed codes to guide the user step by step through routine operations.

This splash proof portable haze meter is supplied in a rigid carrying case that offers protection for harsh environments.

Haze

Beer haze may be defined as an insoluble or semisoluble particulate matter which is small enough to form a colloidal suspension in beer, (typically <2mm). These particles scatter transmitted light and are observed as a degradation in the brilliance of the beer.

Beer clarity is a parameter constantly controlled in the brewery, and to assure consistent product quality, the brewmaster needs more than visual inspection.

Several substances can cause haze in beer, but the most frequently encountered problem is due to a cross-linking of polyphenol and protein. These materials exist in equilibrium in beer and manifest themselves as a haze when polyphenols combine with proteins to form an insoluble colloidal haze.

A range of stabilization treatments is available for avoiding haze problems, and the product has to be controlled in several steps during the brewing process, in particular after filtration and before the beer enters the bright tanks.

TAG IDENTIFICATION SYSTEM

Hanna is the first manufacturer of turbidity instruments that has added the unique T.I.S. - Tag Identification System to portable turbidity meters, to meet the more restrictive needs for traceability and data management of our clients.

The system is designed for scientific and industrial applications, as well as for safety audits and inspections to show that measurements have been taken on pre-established locations.

The system is as easy to install as to operate. Just fix the iButton® tags near your sampling sites that need to be checked often, and with this the T.I.S. is setup. The tag contains a computer chip embedded in durable stainless steel. It is designed to withstand the harsh environments, indoors or outdoors. The number of tags that can be installed is practically unlimited, because each tag has a unique identification code.

Immediately after installation of the tags you can start collecting data. Use the meter to take measurements and memorize the test result by pressing the Log-on-Demand key. Then, the instrument will ask for the tag identification. By simply touching the iButton® with the matching connector on the meter it will identify and authenticate logging, by storing the iButton® serial number, time and date stamp events.

The power of the T.I.S. features resides in the PC application. Download all test data to your PC and use our HI 92000 Windows® compatible application software for further data management. You can sort or filter all your collected data on different criteria (specific sampling location, parameter, date and time intervals) or fix range to filter measured values. The data can be plotted in a graph, exported to other common Windows® applications or printed for reporting purpose.

It is also possible to add new tags later on, thus increasing an already existing database. Each time the PC software recognizes an unregistered tag, it will ask for a description of the new sampling location.

ABBREVIATIONS

| | |
|-------------|--------------------------------------|
| NTU | Nephelometric Turbidity Units |
| FTU | Formazin Turbidity Units |
| ASBC | American Society of Brewing Chemists |
| EBC | European Brewery Convention |
| LCD | Liquid Crystal Display |
| RTC | Real Time Clock |
| TIS | Tag Identification System |

iButton® is registered Trademark of "MAXIM/DALLAS semiconductor Corp."

Windows® is registered Trademark of "MICROSOFT Corporation"

PRINCIPLE OF OPERATION

A light beam obtained from a High Emission 580 nm LED that passes through the sample is scattered in all directions. The intensity and pattern of the scattered light is affected by many variables like wavelength of the incident light, particle size, shape, refractive index and color. The light source LED with a wavelength peaking at 580 nm ensuring that the interference caused by colored samples is minimum. The optical system includes LED, a scattered light detector (90°) and a transmitted light detector (180°). The microprocessor of the instrument calculates the FTU value from the signals that reaches the two detectors.

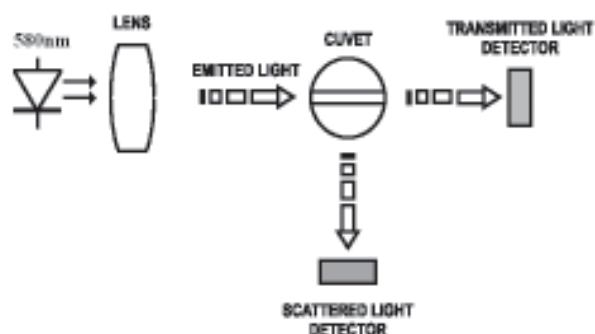

The lower detection limit of a haze meter is determined by the so called “stray light”. Stray light is the light detected by the sensors, that is not caused by light scattering from suspended particles.

The optical system of **HI 847492** haze meter is designed to have very low stray light, providing accurate results also for low haze samples. However, special care must be taken when measuring low haze samples (see General Tips for an Accurate Measurement, page 10).

MEASUREMENT UNITS

Many methods were used to measure turbidity over the years. The Jackson Candle Turbidimeter was used to measure turbidity as Jackson turbidity units (JTU). The method is visual and is not considered very accurate. To obtain more accurate readings a nephelometer should be used as a turbidity reading instrument.

The **HI 847492** haze meter reports the measurements in FTU (Formazin Turbidity Units). FTU units are equal to NTU units (Nephelometric Turbidity Units). The conversion table between these measurement units is shown below:

| | NTU/FNU/FTU | EBC | ASBC | HELM |
|-------------------------|-------------|-------|-------|-------|
| 1 NTU 1 FNU 1 FTU | 1 | 0.25 | 17.25 | 10 |
| 1 EBC | 4 | 1 | 69 | 40 |
| 1 ASBC | 0.058 | 0.014 | 1 | 0.579 |
| 1 HELM | 0.1 | 0.025 | 1.725 | 1 |

SPECIFICATIONS

| | |
|-------------------------|---|
| Range | 0.00 to 9.99 FTU 10.0 to 99.9 FTU 100 to 1000 FTU |
| Range Selection | Automatically |
| Resolution | 0.01 FTU from 0.00 to 9.99 FTU 0.1 FTU from 10.0 to 99.9 FTU 1 FTU from 100 to 1000 FTU |
| Accuracy | $\pm 2\%$ of reading plus 0.05 FTU |
| Repeatability | $\pm 1\%$ of reading or 0.02 FTU, whichever is greater |
| Stray Light | < 0.1 FTU |
| Light Source | LED @ 580nm |
| Light Detector | Silicon Photocell |
| Method | Ratio Nephelometric Method. |
| Display | 60 x 90mm backlit LCD |
| Calibration | Two, three or four point calibration |
| LOG Memory | 200 records |
| Serial Interface | USB 1.1 |
| Environment | 0 to 50°C (32 to 122°F); max 95% RH non-condensing |
| Power supply | 4 x 1.5V AA alkaline batteries or AC adapter |
| Auto Shut-off | After 15 minutes of non-use |
| Dimensions | 224 x 87 x 77 mm (8.8 x 3.4 x 3.0") |
| Weight | 512 g (18 oz.) |

FUNCTIONAL DESCRIPTION

INSTRUMENT DESCRIPTION

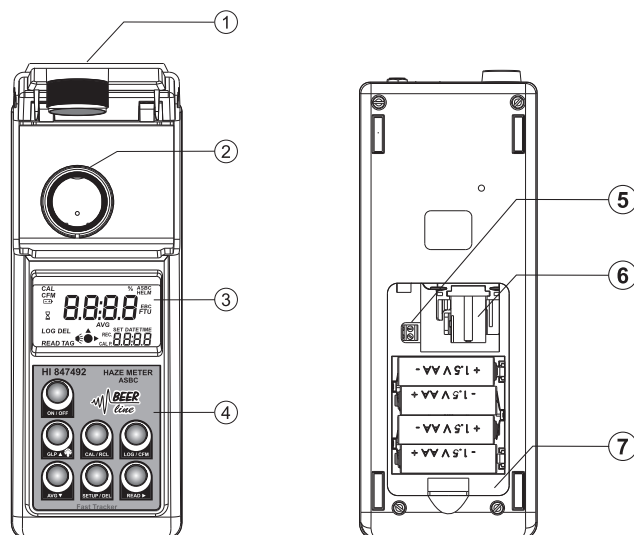

- | | |
|--|-------------------------|
| 1) Cuvet Lid. | 5) LED connector. |
| 2) Cuvet Holder. | 6) LED Holder. |
| 3) Backlit Liquid Crystal Display (LCD). | 7) Battery Compartment. |
| 4) Splash proof keypad. | |

KEYPAD DESCRIPTION

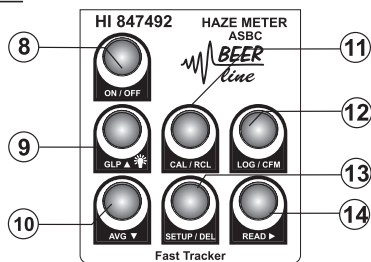

- 8) ON/OFF: press to switch the meter ON and OFF.
- 9) GLP ▲ : press to enter/exit GLP (Good Laboratory Practice) feature. In SETUP this key is used to increase the set values. In Log Recall it is used to select a new record (scroll up). Hold the key for 3 seconds to activate/deactivate the backlight.
- 10) AVG ▼: press to select the AVG (Signal Average Mode) on and off. In SETUP it is used to decrease the set values. In Log Recall it is used to select a previous record (scroll down).

- 11) CAL/RCL: this is a bi-functional key. Just press to enter/exit calibration or in setup mode to start/stop editing a parameter. Hold the key for 3 seconds to enter/exit viewing log content.
- 12) LOG/CFM: press to save a record or to confirm the selected option.
- 13) SETUP/DEL: press to enter/exit setup. The DEL function is available in Log Recall mode to delete one or all records. In GLP it is used to restore factory calibration.
- 14) READ ►: press to start a measurement. Hold the key to make a continuous measurement. In Log Recall mode it is used to view the content of a record. In GLP it is used to view all available information. In Setup, during date or time editing, it is used to select day, month or year and hour/minutes.

CONNECTORS DESCRIPTION

- 15) AC adapter connector.
- 16) USB connector.
- 17) Tag reader.

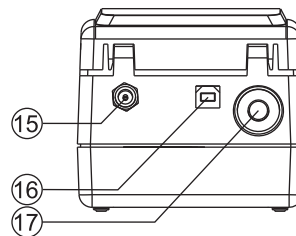

DISPLAY DESCRIPTION

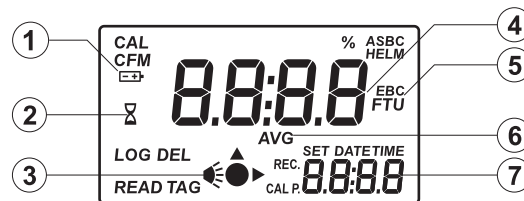

- 1) Battery icon. This icon appears when the status of the battery is displayed or when the battery voltage is getting low.
- 2) Hour glass icon. It is displayed when the instrument performs an internal checkup.
- 3) LED and read status indicator.
- 4) Four digit main display.
- 5) Measurement units. When average or continuous mode is selected, the unit tag blinks for each new displayed value. For conversions in other units see Measurement Units section.
- 6) AVG icon appears when the Signal Average Mode is selected.
- 7) Four digit secondary display.

BEEPER

A long beep indicates an error or an invalid key pressed. A short beep means that the current operation is confirmed.

GENERAL TIPS FOR AN ACCURATE MEASUREMENT

The instructions listed below should be carefully followed to ensure best accuracy.

GENERAL TIPS

- Always cap the cuvetts to avoid spillage of the sample into the instrument.
- Always close the lid of the instrument during measurement.
- Keep the lid of the instrument closed when it is not used to prevent dust or dirt entering.
- Put always the instrument on a flat, rugged surface when taking measurements.

CUVET

The cuvet is part of the optical system and measurements can be affected by the glass imperfections, dirt, dust, scratches, or fingerprints present on the cuvet surface.

CUVET HANDLING

- Any cuvet with visible scratches must be discarded.
- Always store the cuvetts in separate boxes or with separators between them to avoid scratches on the surface.
- Whenever a cuvet is placed into the instrument, it must be dry outside, free of fingerprints or dirt. Wipe it thoroughly with HI 731318 (cloth for wiping cuvetts, see Accessories Section, page 27) or a lint-free tissue prior to insertion.

CUVET OILING

- For low haze readings (<1.0 FTU) the cuvetts should be oiled outside with the supplied **HI 93703-58** Silicone Oil. Use only one single drop of oil and then wipe the cuvet thoroughly with a lint-free cloth.

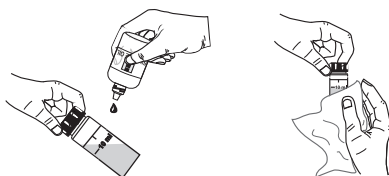

SAMPLING TECHNIQUE

When you make beer haze measurements it is important to take a representative sample.

- The beer to be tested must be placed in upright position in a constant-temperature bath and hold for 24 hours at 0°C.
- Pre-chill a cuvet in small ice-water bath containing wetting agent (external contact only).
- Without disturbing any sediment rinse and then fill cuvet with test sample.
- Place the cuvet in the small ice-water and degas beer by stirring. The HI 98501-1 Checktemp

thermometer will be used to read the beer temperature.

- When the beer temperature is 0°C (32°F) place the cuvet in the meter and immediately start the reading.

MEASUREMENT TIPS

- For a correct filling of the cuvet: the liquid in the cuvet forms a meniscus; the bottom of this meniscus must be at the same level of the 10 mL mark.



CALIBRATION PROCEDURE

It is recommended to calibrate the meter only with Hanna ready-to-use calibration standard solutions. Alternatively, formazin standards can be used. The prepared formazin solutions should be close to the default calibration points. The first point must be near 0 FTU, the second point between 10 and 20 FTU, the third point between 50 and 150 FTU and the fourth point between 700 and 900 FTU.

CALIBRATION

Calibration can be performed in two, three or four points. It is possible to interrupt calibration procedure at any time by pressing ON/OFF.

- Turn the instrument on by pressing ON/OFF. When the LCD displays "----", the instrument is ready.

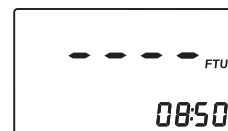

- Enter calibration mode by pressing CAL/RCL. The display will show "CAL P.1".



- Place the <math><0.1</math> FTU standard cuvet into the holder.

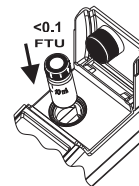

- Close the lid and press READ. "----" and the "LED and Read Status" indicator will blink on the display.

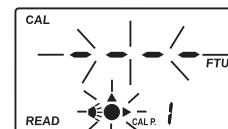

Alternatively, press LOG/CFM to skip the first calibration point.

- Then the LCD will show the second calibration point (15.0 FTU) and "CAL P.2", while "READ" is blinking.

Note: If you're using different calibration standards, change the displayed value by pressing UP or DOWN keys until the display shows the desired value.

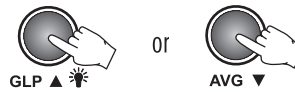
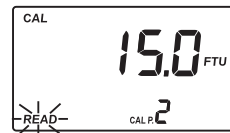

- Remove the <0.1 FTU standard cuvet and place the 15.0 FTU standard cuvet into the holder.

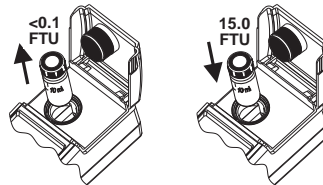

- Close the lid and press READ ►. "----" and the "LED and Read Status" indicator will blink again while making the reading.

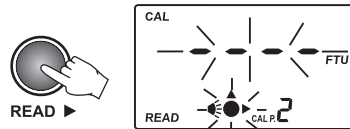

- At the end of the reading, the third calibration point (100 FTU) and "CAL P.3" is displayed. If desired, the value can be changed using the UP or DOWN keys.

Note: At this moment it is possible to exit calibration by pressing CAL/RCL. The instrument will memorize the two-point (<0.1 and 15.0 FTU) calibration data and will return to measurement mode.

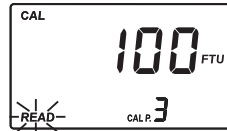

- Remove the 15.0 FTU standard cuvet from the meter and place the 100 FTU standard cuvet into the holder.

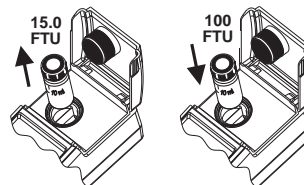

- Close the lid and press READ ►. "----" and the "LED and Read Status" indicator will blink again while making the reading.

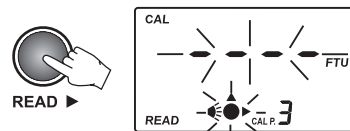

- At the end of the reading, the fourth calibration point (800 FTU) and "CAL P.4" is displayed. If desired, the value can be changed using the UP or DOWN keys.



Note: At this moment it is possible to exit calibration by pressing CAL/RCL. The instrument will memorize the three-point (<0.1, 15.0 and 100 FTU) calibration data and will return to measurement mode.

- Remove the 100 FTU standard cuvet from the meter and insert the 800 FTU standard cuvet into the holder.

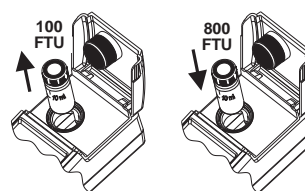

- Close the lid and press READ ►: "----" and the "LED and Read Status" indicator will blink again while making the reading.

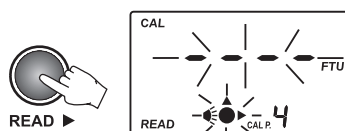

- At the end of the measurement, the four-point calibration is completed and the instrument returns automatically to measurement mode.

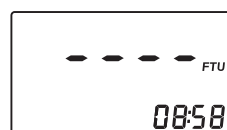

OUT CAL RANGE FUNCTION

The instrument has an **Out Cal Range** function to prevent taking measurements in a range where the calibration do not assure the best results. The range where the calibration assures correct measurements is up to 40 FTU for a two-point calibration and up to 150% of the third point value for a three-point calibration.

The display will show a blinking "CAL" tag each time the measurements are taken outside the calibration range.



CALIBRATION ERRORS

- If the read value during calibration is too far from the set value, the instrument will show "-LO-" or "-HI-" error.

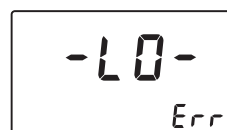

or

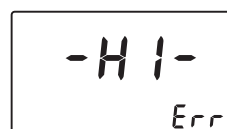

- If the calculated calibration coefficients are off specifications, the "CAL Err" message is displayed.

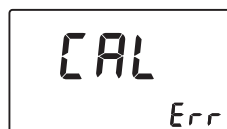

DELETE CALIBRATION

HI 847492 is factory calibrated. It is possible to restore factory calibration by deleting last performed calibration.

To delete last calibration, follow the next steps:

- Enter the GLP feature by pressing GLP ▲ . The date of the last calibration will be displayed on the LCD (e.g. 2007.01.23).
- Press READ ► to scroll through the information related to calibration. The last panel is the one with "Delete Calibration".
- Press SETUP/DEL to delete the current calibration. After deletion the instrument will automatically return to measurement mode and the factory calibration is restored.

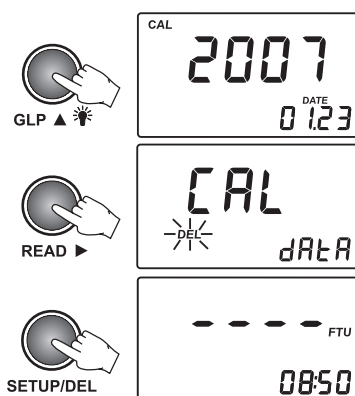

HAZE MEASUREMENT

Note: For beer analysis it is recommended to work always with the AVG mode on.

- Turn the instrument ON by pressing ON/OFF.



- When the LCD displays "----", the instrument is ready. The current time appears on the secondary LCD, if selected in Setup menu.

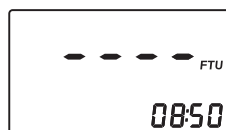

- Follow the procedure described in the MEASUREMENT TECHNIQUE section.

Note: To remove any fingerprints or dirt, wipe the cuvet thoroughly with a lint-free cloth. If

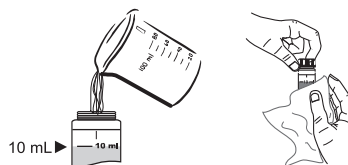

necessary, apply HI 93703-58 Silicone Oil (see General Tips for an accurate measurements, page 10), recommended only if low haze values need to be read.

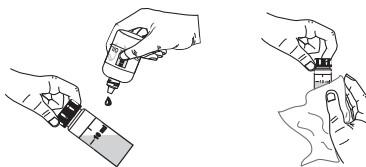

- Place the cuvet into the instrument and close the lid.

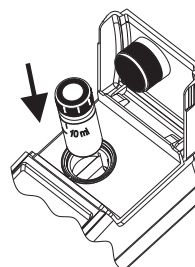

- Press READ ► and “----” will blink on the display.

- At the end of the measurement, the instrument directly displays haze in FTU.

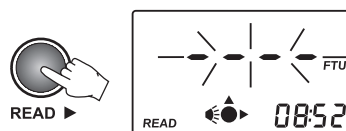

AVG (SIGNAL AVERAGE MODE)

It is recommended to select this measurement mode when you work with unstable samples that contain suspended particles of different dimensions.

In the AVG mode the instrument takes 20 measurements in a short period of time and displays the updated averaged value.

- To select the averaged measurement mode press the AVG ▼ key and the AVG icon will appear on the LCD.

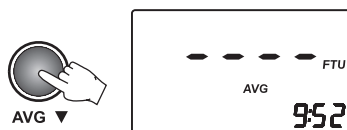

Note: to return to the normal measurement mode just press again the AVG ▼ key.

- Press READ ► and “----” will blink on the display. After a few seconds the instrument displays the first reading. The meter continues updating the readings until the “LED and Read Status” indicator turns off. The final displayed value is the averaged reading of turbidity in FTU.

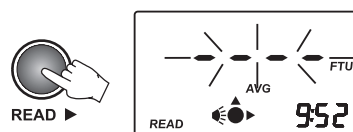

CONTINUOUS MEASUREMENT

This measurement mode can be used to verify how fast suspended parts settle out. Please verify first that the AVG mode is turned off (see instructions above). To make continuous measurement keep the READ ► key pressed until the desired number of measurements are taken.

The last value remains on the display after the READ ► key is released.

LOGGING

HI 847492 has a log space for up to 200 records. With each measurement, the date, time and tag ID is stored. In this way, each record is fully characterized and can be easily analyzed when downloading data on the PC application (HI 92000).

LOGGING

The log function is active after a valid measurement is obtained (no errors).

- To log a value, press LOG/CFM when the measurement result is displayed.

The instrument asks to READ TAG for identification of the sampling location. The location for the new record is also displayed on the secondary LCD.

- To read the ID code for the sampling location identification, simply touch the iButton® tag with the matching connector, located on the back of the instrument (see Connectors Description, page 9). Alternatively, press again LOG/CFM to store the record without the tag ID code.

- If the tag is successfully read, the instrument will beep once, displaying the unique hexadecimal code of the tag, and store the data.

After data is stored, the instrument returns to measurement mode.

- Notes:**
- If the tag is not read within 20 seconds, the logging procedure is canceled.
 - A measurement can be stored only once. Also an over range value can be stored.

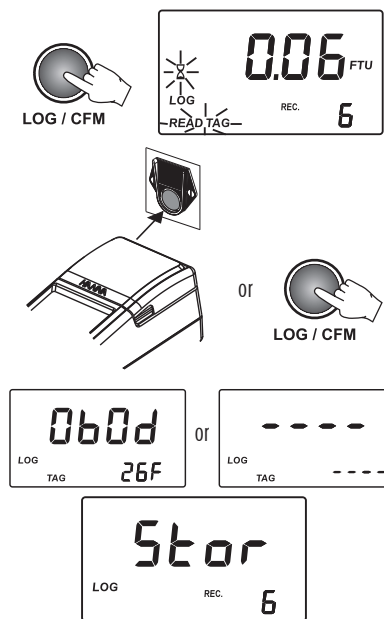

- If less than ten free records are available, the "LOG" tag will blink while storing data.
- If the log memory is full, the "LoG FULL" message will appear for a few seconds on the LCD and the instrument will return to measurement mode without storing the new record.

To store a new record, delete one or more records.

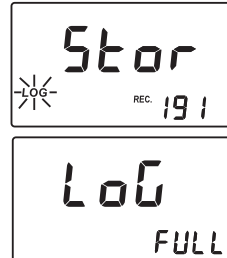

VIEW LOGGED DATA

The stored records can be viewed by pressing CAL/RCL key for a few seconds. To return to normal measurement mode, press CAL/RCL key again .



LOG SEARCHING

The log records are stored in chronological order. The first displayed record is the last stored one.

- Press UP or DOWN keys to scroll the log memory record by record. By holding the UP or DOWN keys, the scrolling speed will increase. The scrolling of the log is possible from any panel of the record, except "Delete last log" and "Delete all logs" panels.
- When scrolling the log, the number of the record is displayed for one second on the secondary LCD together with "TAG" if the identification of the sampling location was made.

When the end of the log is reached, an error beep is heard.

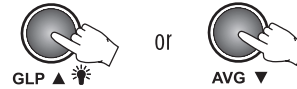

RECORD VIEWING

Each record contains more information than the measured value. The additional information is grouped in several panels.

Press READ ► to scroll through the record panels. The record panels are displayed one by one in a circular way.



Each record contains the following panels:

- The record value (haze value) and record number.

Note: If the logged sample value is an over range reading, the maximum value (1000 FTU) will be displayed blinking.

- The hexadecimal string of the tag for the sampling location ID.

Note: If the ID data are missing, "----" is displayed instead.

- Measurement date in YYYY.MM.DD format.
- Measurement time in hh:mm format.
- Delete the last record panel (only for last record).
- Delete all records.

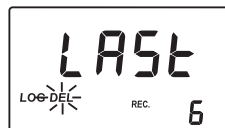
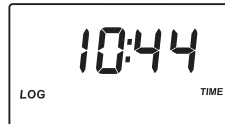
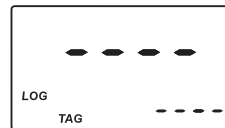

DELETE LAST RECORD

To delete the last record, scroll through the log menu until the delete last record panel is displayed.

- To delete the last record, press SETUP/DEL when the "Delete last records" panel is displayed.
- The instrument asks for confirmation. Press the LOG/CFM key to confirm the last record is deleted. To abort the delete function, press READ ► instead of LOG/CFM.

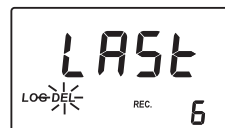

- After the record is deleted, the instrument goes immediately to the first panel of the previous record. If the log becomes empty, “----” will be displayed for one second and the instrument will return to measurement mode.



DELETE ALL RECORDS

To delete all records, scroll through the log until delete all records panel is displayed.

- To delete all records press SETUP/DEL when the “Delete all records” panel is displayed.
- The instrument asks for confirmation. Press the LOG/CFM key to confirm all records are deleted. To abort the delete function, press READ ► instead of LOG/CFM.
- After all records are deleted the instrument returns to measurement mode.

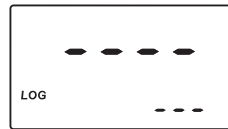

GOOD LABORATORY PRACTICE (GLP)

The GLP feature allows the user to view last calibration data. Also the user calibration can be deleted.

- Press GLP ▲ to enter or exit GLP data consulting. Several functions are available when in GLP menu. Press READ ► to scroll through the GLP data.

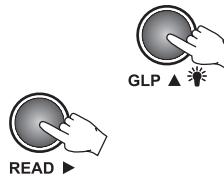

The following GLP panels can be viewed.

- The last calibration date, in YYYY.MM.DD format. If no calibration was performed, the factory calibration message, “F.CAL”, will be displayed on the LCD.
- The time of the last calibration in hh:mm format.

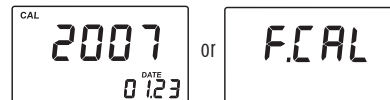

- First calibration point: 0.00 FTU if skipped or the actual read value (e.g. 0.01 FTU).



- Second calibration point.



- Third calibration point (if available).



- Fourth calibration point (if available).



- Delete calibration panel.

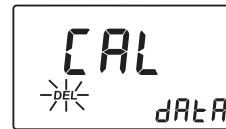

To delete calibration:

- Press SETUP/DEL when the instrument displays the "Delete calibration" panel.
The user calibration will be deleted and the factory calibration will be restored. The instrument will switch automatically to idle mode.



SETUP

The Setup mode allows the user to view and modify the instrument parameters. When the blinking "CAL" tag appears during SETUP mode, press CAL for editing parameters.

- To enter/exit SETUP, press SETUP/DEL.



- To select the parameter to be edit, press UP or DOWN keys until the desired panel is displayed.



OR



SET UNIT

The measure unit can be set between FTU, HELM, ASBC and EBC.

- To set a new measure unit, press CAL/RCL when the unit panel is displayed. The parameter setting and “CFM” tag will start blinking.
- Press the UP or DOWN keys to select the measure unit.
- Press LOG/CFM to save the change. The new selected option of the parameter will be displayed on the LCD. Alternatively, press CAL to exit without saving the changes.

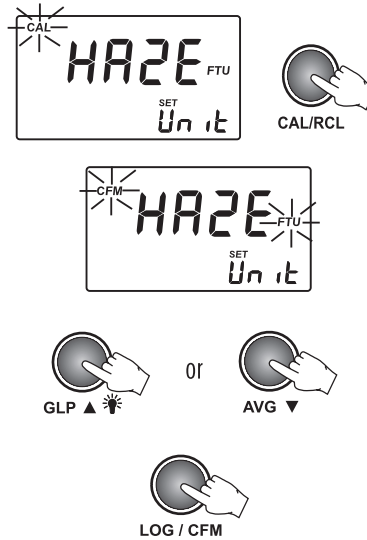

SET BEEPER

The HI 847492 has a built-in beeper that signals the tag read, the key press and the error conditions. The beeper can be selected to be on or off.

- To set the beeper on or off, press CAL/RCL when set beeper panel is displayed. The beeper status and the CFM tag will start blinking.
- Press the UP or DOWN keys to set the beeper on or off.
- Press LOG/CFM to save the change. The new selected option will be displayed on the LCD. Alternatively, press CAL to exit without saving the changes.

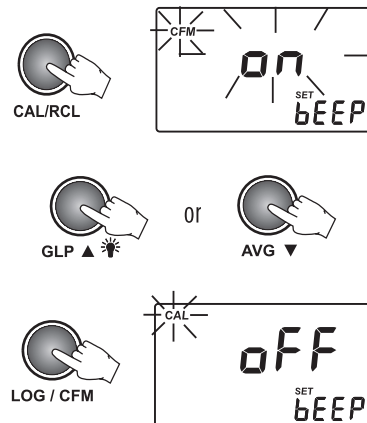

SHOW / HIDE THE TIME

You can choose between showing or hiding the current hour and minutes on the secondary LCD.

- To set hiding or showing the time, press CAL/RCL when the "Show/hide time" panel is displayed.

The time show status and the CFM tag will start blinking.

- Press the UP or DOWN keys to set Lcd / hide for time.

- Press LOG/CFM to save the change. The new selected option will be displayed on the LCD. Alternatively, press CAL/RCL to exit without saving the changes.

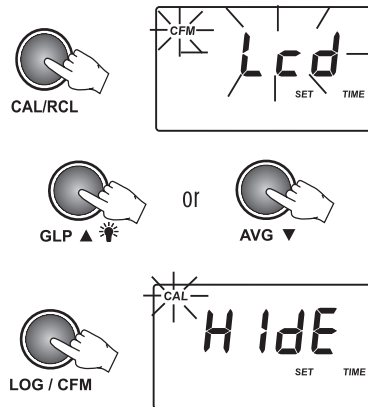

SET THE DATE

The HI 847492 haze meter has a built-in real time clock (RTC). The RTC time is used to generate a unique time stamp for each recorded value and to automatically store the last calibration date. The current time can be displayed on the LCD when the instrument is in measurement mode.

- To set the current date, press CAL/RCL when the "Set date" panel is displayed. The date format is YYYY.MM.DD. The last two digits of the year value and CFM tag will start blinking.

- Press the UP or DOWN keys to set the year value.

- Press LOG/CFM or READ ► to start editing the month value. The month value will start blinking.

- Press the UP or DOWN keys to set the month value.

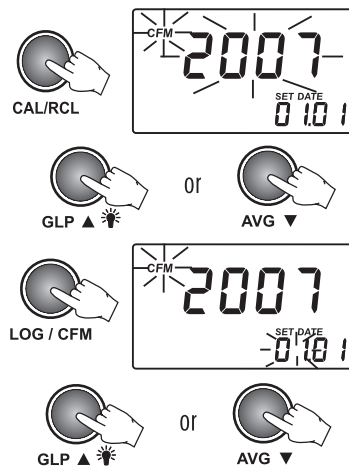

- Press LOG/CFM or READ ► to start editing the day value. The day value will start blinking.

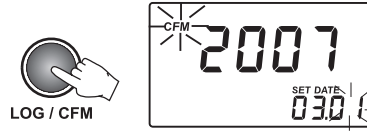

- Press the UP or DOWN keys to set the day value.
Note: to edit the year again, after the day was set, press READ ►.

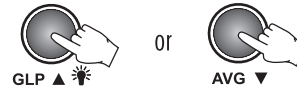

- Press LOG/CFM to save the new date. The new date will be displayed on the LCD. Alternatively, press CAL/RCL to exit without saving the changes.

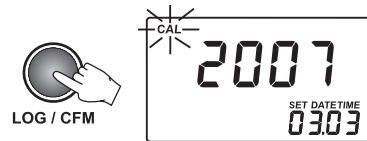

SET THE TIME

- To set the current time, press CAL/RCL when the "Set time" panel is displayed. The time format is hh:mm. The hour value and "CFM" tag will start blinking.



- Press the UP or DOWN keys to set the hour value.

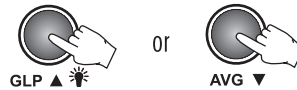

- Press LOG/CFM or READ ► to start editing the minutes. The minutes value will start blinking.

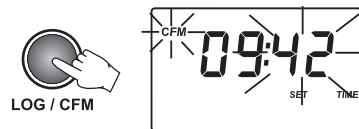

- Press the UP or DOWN keys to set the minutes value.

Note: To edit the hour again, after the minutes were edited, press READ ►.

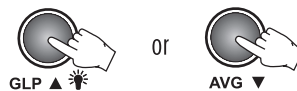

- Press LOG/CFM to save the new time. The new set time will be displayed. Alternatively, press CAL/RCL to exit without saving the changes.

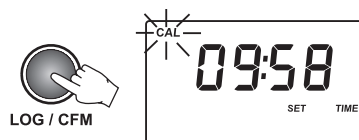

SET INSTRUMENT ID

The instrument ID is a four digit number that can be edited by the user. The instrument ID is downloaded on the PC application, together with the logged data. By setting a different ID for each instrument it is possible to combine information from many turbidimeters into the same database.

- To set the instrument ID, press CAL/RCL when the "Set instrument ID" panel is displayed. The default instrument ID is 0000. The existing ID value and the CFM tag will start blinking.
- Press the UP or DOWN keys to set the new instrument ID. By pressing and holding the UP or DOWN keys, the changing speed will increase.
- Press LOG/CFM to save the change. The new instrument ID will be displayed. Alternatively, press CAL/RCL to exit without saving the changes.

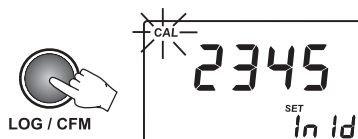
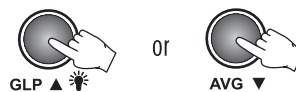

LCD BACKLIGHT

The LCD can be illuminated to allow the user to see the readings even in the dark.

To turn on or off the backlight, hold the GLP ▲ key for 3 seconds. The backlight will automatically shut-off after 25 seconds of non-use to save the battery life.



TAG INSTALLATION

The tag is housed in rugged stainless steel that can withstand harsh conditions. However, it is better to protect the tag from direct rain.

Place the tag near a sampling point. Fix it securely with the screws provided, in such a way that the metallic iButton® is easily accessible for reading the tag.

The number of tags that can be installed is practically unlimited. Additional tags can be ordered.

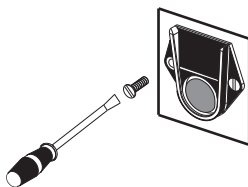

(See Accessories, page 27 for HI 920005 - five tag holders with tags.)

BATTERY MANAGEMENT

For field measurements, HI 847492 is powered by 4 AA batteries. The battery life is enough for 3500 normal measurements.

When you turn the instrument on, the remaining estimated battery life reported in percents.

To save the battery life, the instrument will turn off after 15 minutes of non-use. The backlight will turn off 25 seconds after the last key is pressed.

The battery life is measured each time the lamp is turned on and if the remaining battery life is less than 10%, the battery tag will blink on the LCD to advise the user to replace the batteries.

When the batteries are completely discharged, "0% bAtt" message will be displayed for one second and the instrument will turn off. In order to use the instrument again, replace the batteries or use an AC adapter.

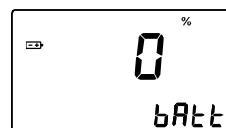
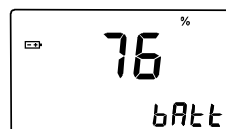

BATTERY REPLACEMENT

To replace the batteries follow the next steps:

- Turn OFF the instrument by pressing the ON/OFF button.
- Open the battery cover by pressing the locking clip.

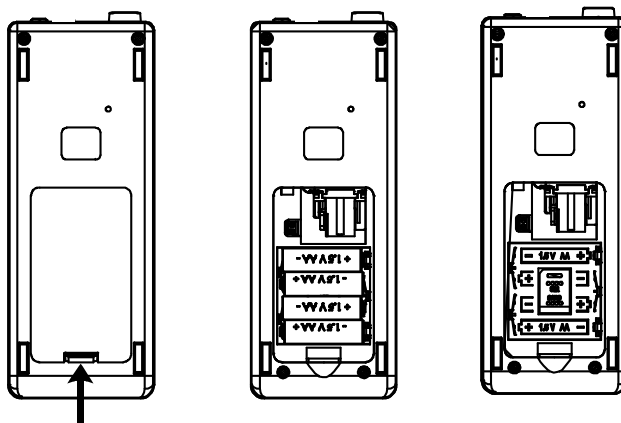

- Take out the used batteries and insert 4 new 1.5 AA size batteries, paying attention to the correct polarity as indicated on the battery compartment.
- Replace the cover and press it until it locks.

Warning: Replace batteries only in a non-hazardous area.

ERROR CODES

HI 847492 has a powerful diagnostic system. Common errors are detected and reported for easy diagnostic and maintenance.

| ERROR | DESCRIPTION | ACTION |
|---------------------------------------|--|--|
| Err1; Err2; Err3; Err6; Err7; Err8 | Critical errors. The instrument beeps and shuts down. | Contact your nearest HANNA Customer Service Center |
| Err4 | The instrument beeps shortly twice and shuts down after 10 seconds. | Press simultaneously UP and DOWN to reset |
| CAP | The lid is not closed. | Close the lid. If the error persists, contact your nearest HANNA Customer Service Center |
| no L | LED malfunction or no light. | Check the optical system for obstructions. Replace the LED. |
| L Lo | Not enough light. | Check the optical system for obstructions. |
| -LO- | The standard used for current calibration point is too low. | Check the standard and use the correct one. |
| -HI- | The standard used for current calibration point is too high. | Check the standard and use the correct one. |
| Battery tag blinking | The remaining battery life is too low. | Replace batteries. |
| bAtt | The batteries are too discharged for correct measurements. | Replace batteries. |

PC INTERFACE

To fully use the instrument tag identification system function, the measured data has to be downloaded to a computer. The instrument uses USB connection to communicate with the PC. To use the USB protocol, simply connect a regular USB cable between instrument and PC. In both cases, the PC must run the **HI 92000** application for successful data transfer.

ACCESSORIES

| | |
|--------------|---|
| HI 93703-58 | Silicone oil (15 mL) |
| HI 847492-11 | Calibration cuvetts kit |
| HI 731331 | Glass cuvetts (4 pcs) |
| HI 731335N | Caps for cuvetts (4 pcs) |
| HI 93703-50 | Cuvetts cleaning solution (230 mL) |
| HI 731318 | Cloth for wiping cuvetts (4 pcs) |
| HI 740220 | 25 mL glass vial with cap (2 pcs) |
| HI 92000 | Windows® compatible software |
| HI 920005 | 5 tag holders with tags |
| HI 740027P | 1.5V AA battery (12 pcs) |
| HI 710005 | Voltage adapter from 115V to 12 VDC (USA plug) |
| HI 710006 | Voltage adapter from 230V to 12 VDC (European plug) |
| HI 710012 | Voltage adapter from 240V to 12 VDC (UK plug) |
| HI 710013 | Voltage adapter from 230V to 12 VDC (South Africa plug) |
| HI 710014 | Voltage adapter from 230V to 12 VDC (Australia plug) |

Recommendations for Users

Before using these products, make sure that they are entirely suitable for your specific application and for the environment in which they are used.

Operation of these instruments may cause unacceptable interferences to other electronic equipment, thus requiring the operator to take all necessary steps to correct interferences.

Any variation introduced by the user to the supplied equipment may degrade the instruments' EMC performance.

To avoid damages or burns, do not put the instrument in microwave ovens. For yours and the instrument safety do not use or store the instrument in hazardous environments.

| |
|--|
| Hanna Instruments reserves the right to modify the design, construction and appearance of its products without advance notice. |
|--|

SALES AND TECHNICAL SERVICE CONTACTS

Australia:

Tel. (03) 9769.0666 • Fax (03) 9769.0699

China:

Tel. (10) 88570068 • Fax (10) 88570060

Egypt:

Tel. & Fax (02) 2758.683

Germany:

Tel. (07851) 9129-0 • Fax (07851) 9129-99

Greece:

Tel. (210) 823.5192 • Fax (210) 884.0210

Indonesia:

Tel. (21) 4584.2941 • Fax (21) 4584.2942

Japan:

Tel. (03) 3258.9565 • Fax (03) 3258.9567

Korea:

Tel. (02) 2278.5147 • Fax (02) 2264.1729

Malaysia:

Tel. (603) 5638.9940 • Fax (603) 5638.9829

Singapore:

Tel. 6296.7118 • Fax 6291.6906

South Africa:

Tel. (011) 615.6076 • Fax (011) 615.8582

Taiwan:

Tel. 886.2.2739.3014 • Fax 886.2.2739.2983

Thailand:

Tel. (662) 619.0708.11 • Fax (662) 619.0061

United Kingdom:

Tel. (01525) 850.855 • Fax (01525) 853.668

USA:

Tel. (401) 765.7500 • Fax (401) 765.7575

*For e-mail contacts and a complete list of Sales and Technical offices, please see
www.hannainst.com.*

MAN847492
10/07