

Rotator

User Manual



MX-RD-Pro

Rotator

MX-RL-Pro

Rotator

Please read the User Manual carefully before use, and follow all operating and safety instructions!

Technical specifications and outline are subject to change without prior notice.

www.dlabsci.com



Contents

Preface.....	1
Service.....	1
Warranty.....	1
1. Safety Instructions.....	2
2. Proper Use.....	3
3. Inspection.....	3
3.1 Receiving Inspection.....	3
3.2 Listing of Items.....	3
4. Function.....	4
4.1 Control.....	4
4.2 Display.....	5
5. Installation.....	6
6. Operation.....	7
7. Faults.....	8
8. Maintenance and Cleaning.....	8
9. Associated standards and regulations.....	9
10. Specifications.....	10
11. Ordering Informations.....	10

Preface

Welcome to the “Rotator User Manual”. Users should read this manual carefully, follow the instructions and procedures, and beware of all the cautions when using this instrument.

Service

When help needed, you can always contact the service department of manufacturer for technical support in the following ways:

DLAB Scientific Instrument Inc.

2311 E. Locust Court, Ontario, CA 91761 United States.

Office: +1-747-230-5179

Fax: +1-909-230-5275

Sales contact: info@dlabsci.com

Service contact: service@dlabsci.com

www.dlabsci.com

Please provide the customer care representative with the following information:

- Serial number (on the rear panel)
- Certification
- Description of problem (i.e., hardware or software)
- Methods and procedures adopted to resolve the problems
- Your contact information

Warranty

This instrument is warranted to be free from defects in materials and workmanship under normal use and service, for a period of 24 months from the date of invoice. The warranty is extended only to the original purchaser. It shall not apply to any product or parts which have been damaged on account of improper installation, improper connections, misuse, accident or abnormal conditions of operation.

For claims under the warranty please contact your local supplier. You may also send the instrument directly to manufacturer, enclosing the invoice copy and by giving reasons for the claim.

1. Safety Instructions



Warning!

- Read the operating instructions carefully before use.
- Ensure that only trained staff works with the instrument.



Protective ground contact!

- Ensure the socket must be grounded (protective ground contact) before use.

- When working wear personal safety guards to avoid the risk of:
 - Splashing liquids
 - Broken glass containers
- Follow the safety instructions, guidelines and accident prevention regulations.
- Do not touch the running parts, moving instrument care not rolling your fingers.
- Set up the instrument in a spacious area on a stable, clean, non-slip, dry and fireproof surface. Do not operate the instrument in explosive atmospheres, with hazardous substances or under water.
- If the instrument does not run smoothly, please decrease the motor speed.
- Firmly secure the accessories and vessels in place to avoid damage or risk.
- Preparation of samples may lead to dangerous flammable. Only process samples that will not react dangerous.
- Use the standard accessories listed in the “accessories” section, and follow the instructions to use accessories to ensure safety. Please switch off the power before assembly of accessories, confirm the instrument and accessories are intact before switch on each time.
- The instrument only be opened by expert, please switch off before use.
- The voltage stated on the nameplate must correspond to the mains voltage.
- Do not cover the instrument during running. Prevent the collision and extrusion to instrument and accessories.
- Keep away from high magnetic field.

2. Proper Use

The instrument is designed for mixing sticky substance in schools, laboratories or factories. It can be installed on a variety of impeller, for different viscosity of the medium. This instrument is not suitable for using in residential areas or other constraints mentioned in Chapter 1.

Do not use the accessories recommended by the manufacturer, or failure to use the instructions, may be caused unsafe situation.

3. Inspection

3.1 Receiving Inspection

Unpack the instrument carefully and check for any damages which may have arisen during transport. If it happens, please contact manufacturer/supplier for technical support.



Note:

If there is any apparent damage to the system, please do not connect to the power line.

3.2 Listing of Items

Items	Qty
Main unit	1
Power cable	1
User manual	1

Table 1

4. Function

4.1 Control

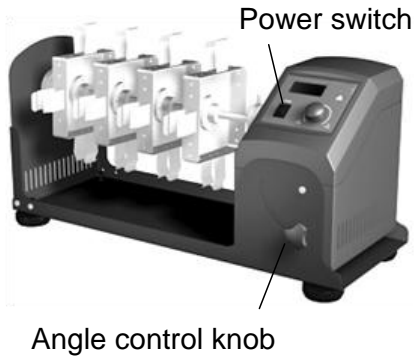

Figure 1

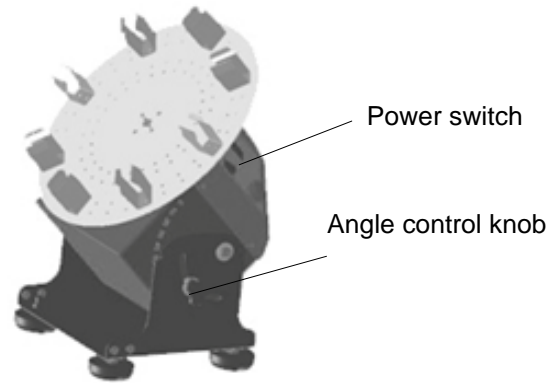

Figure 2

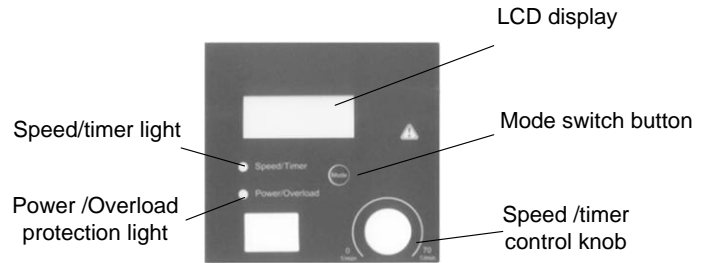

Figure 3

Items	Default settings
Mode switch button Mode	Shift speed and time display.
Speed /timer control knob	Set speed and time by rotating speed/timer control knob. Push on/off to start/stop rotating function.
Speed/timer light Speed/Timer	Green/Red LED display light. Different colors of LED light show the value for speed or time that LCD screen currently displays. Green LED light shows that LCD screen currently displays speed. Red LED light shows that LCD screen currently displays time.
Power/Overload protection light Power/Overload	Green/Red LED display light. LED light shows green when switch on, LED light shows red when starts overload protection. When the torque reaches limited value, overload protection function will be started. At the same time overload

	protection light flashes, while the system stops running.
LCD display	LCD displays the real working state and all setting values.
Power switch I/O	Switch ON or OFF the instrument.

Table 2

4.2 Display



Figure 4

Display	Descriptions
Set	Display when set target value.
Err	Display in case of error happening.
Display area	When Set displays, this area shows setting value; When Set disappears, this area shows running value.

Table 3

5. Installation

- Installing connecting plate

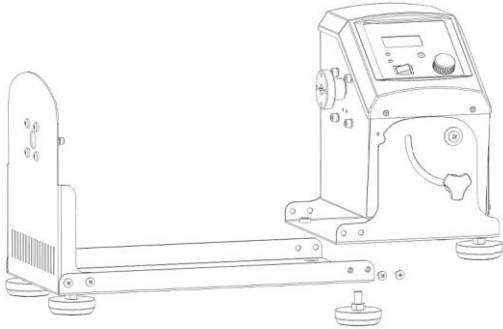

Figure 5

- Rotating the knurled screw counter clockwise and setting the unit at an angle of approx. 45° .

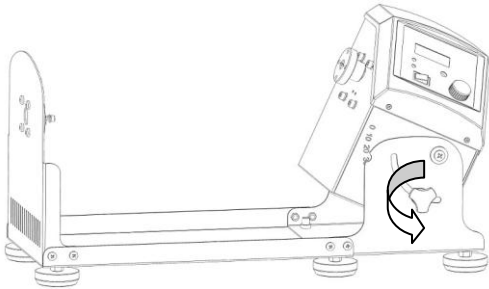

Figure 6

- Installing rotisserie accessory

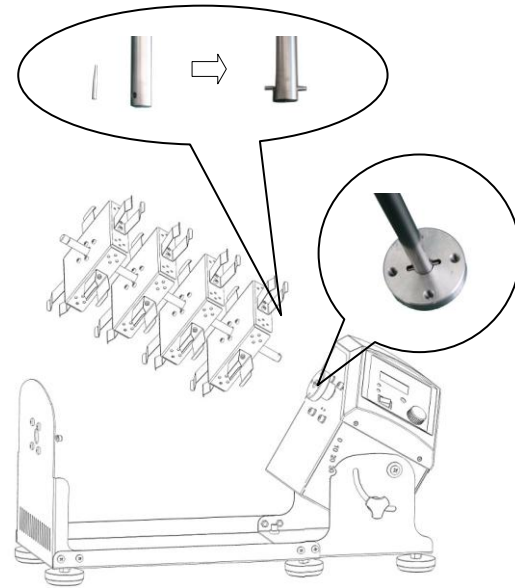

Figure 7

- Rotating the knurled screw counter clockwise and setting the unit at an angle of 0° .

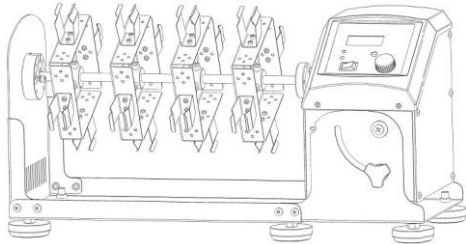

Figure 8

- Changing disk accessory

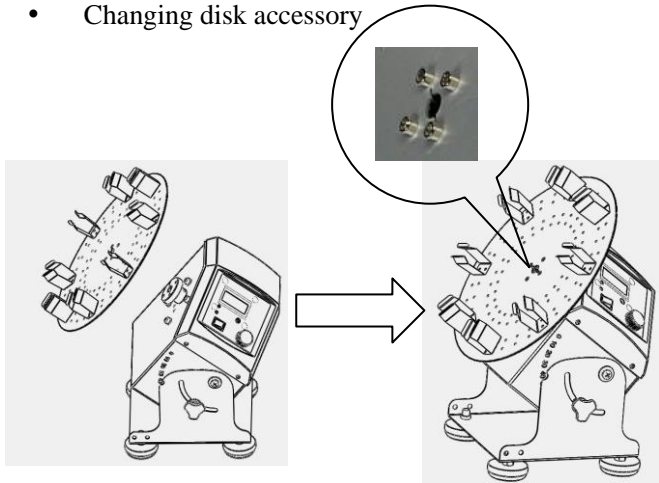

Figure 9

6. Operation

- Place the Rotator in safe and stable surface, ensure the required operating voltage and power supply voltage matched, and the socket must be earthed reliably.
- Connect the power cable.
- Switch ON instrument.
- The instrument begins self-checking.
- When initialization is over, LCD displays the last running values of speed.
- Rotate the speed/timer control knob to set target speed.
 - a. Press the speed/timer control knob to start rotating function. Press the knob again to stop rotating function.
 - b. Press the mode switch button, LCD displays time, and then rotating the speed/timer control knob to set target time. Press the speed/timer control knob to start rotating function at the set time. During operation, motion can be stopped at any time by pressing the speed/timer control knob. If the knob is pressed again, motion will start again and the timer will restart countdown. When the timer reaches zero, the unit will

be automatically halted and an alert will sound.

If these operations above are normal, the instrument is ready to operate. If not, the instrument may be damaged during transportation, please contact technical support of manufacturer/supplier.



Note:

The set values can be altered at any time.

7. Faults

- Instrument cannot be powered ON when start rotating function.
 - Check whether the power cable is connected.
- Rotating function suddenly stop
 - Power/overload protection light changed to red, LCD displays “Er 03”, indicate the current failure is “overload protection”.
 - Pressing the speed/timer control knob first to close rotating function, and then restart rotating function after lowered load. If rotating function cannot start, then repeat the process and gradually reduce load.

8. Maintenance and Cleaning

- Proper maintenance can keep instrument working properly and lengthen its lifetime.
- Do not spray cleanser into the instrument when cleaning.
- Do not remove the power line when cleaning. Only use recommended cleansers:

Dyes	Isopropyl alcohol
Construction materials	Water containing tenside / Isopropyl alcohol
Cosmetics	Water containing tenside / Isopropyl alcohol
Foodstuffs	Water containing tenside
Fuels	Water containing tenside

- Before using other method for cleaning or decontamination, the user must ascertain with the manufacturer that this method will not damage the instrument. Wear the proper protective gloves during cleaning of the instrument.



Note:

- Electronic device cannot clean with cleanser.
- If you require maintenance service, must be cleaned the instrument in advance to avoid pollution of hazardous substances, and to send back into original packing.
- If the instrument will not use for a long time, please switch off and place in a dry, clean, room temperature and stable location.

Changes or modifications not expressly approved by the party responsible for compliance could void the user's authority to operate the equipment.

NOTE: This equipment has been tested and found to comply with the limits for a Class A digital device, pursuant to Part 15 of the FCC Rules. These limits are designed to provide reasonable protection against harmful interference when the equipment is operated in a commercial environment. This equipment generates, uses, and can radiate radio frequency energy and, if not installed and used in accordance with the instruction manual, may cause harmful interference to radio communications. Operation of this equipment in a residential area is likely to cause harmful interference in which case the user will be required to correct the interference at his own expense.

9. Associated standards and regulations

Construction in accordance with the following safety standards:

EN 61010-1

UL 3101-1

CAN/CSA C22.2(1010-1)

EN 61010-2-10

Construction in accordance with the following EMC standards:

EN 61326-1

10. Specifications

Items	Specifications
Voltage [VAC]	100~240
Frequency [Hz]	50/60
Power [W]	40
Angle range	0° ~ 90°
Motor type	DC motor
Speed range [rpm]	10~70
Speed display	LCD
Timer range [min]	1~1199
Timer display	LCD
Run type	Timer/Continuous operation
Overall Dimensions [mm]	512×190×250
Weight [kg]	6.5
Permissible ambient temperature [°C]	5—40
Permissible relative humidity	80%





Items	Specifications
Protection class acc. to DIN EN60529	IP21

Table 4

11. Ordering Informations

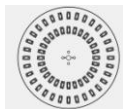
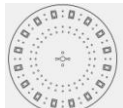
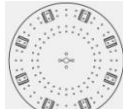
Cat. No.	Descriptions
824232017777	MX-RD-Pro, LCD Digital Rotator, used with disk accessories, variable speed, adjustable mixing angle, US plug, 100V-240V, 50Hz/60Hz
824232117777	MX-RD-Pro, LCD Digital Rotator, used with disk accessories, variable speed, adjustable mixing angle, Cn plug, 100V-240V, 50Hz/60Hz
824232217777	MX-RD-Pro, LCD Digital Rotator , used with disk accessories, variable speed, adjustable mixing angle, Euro plug, 100V-240V, 50Hz/60Hz

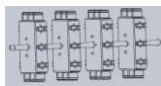
Rotator

			Cat. No	Descriptions
824232317777	MX-RD-Pro, LCD Digital Rotator , used with disk accessories, variable speed, adjustable mixing angle, UK plug, 100V-240V, 50Hz/60Hz		18900137	Disk, 1.5ml centrifuge tube, capacity: 60ea
824222017777	MX-RL-Pro, LCD Digital Rotator , used with rotisserie accessories, variable speed, adjustable mixing angle, US plug, 100V-240V, 50Hz/60Hz		18900138	Disk, 15ml centrifuge tube, capacity: 16ea
824222117777	MX-RL-Pro, LCD Digital Rotator , used with rotisserie accessories, variable speed, adjustable mixing angle, Cn plug, 100V-240V, 50Hz/60Hz		18900139	Disk, 50ml centrifuge tube, capacity: 8ea
			18900140	Post for installing disk together
824222217777	MX-RL-Pro, LCD Digital Rotator , used with rotisserie accessories, variable speed, adjustable mixing angle, Euro plug, 100V-240V, 50Hz/60Hz		18900142	1.5ml Centrifuge tube, capacity: 48ea, horizontal mount
824222317777	MX-RL-Pro, LCD Digital Rotator , used with rotisserie accessories, variable speed, adjustable mixing angle, UK plug, 100V-240V, 50Hz/60Hz		18900143	15ml Centrifuge tube, capacity: 24ea, horizontal mount
			18900144	50ml Centrifuge tube, capacity: 24ea, horizontal mount
Accessories				
	Cat. No	Descriptions		

	Cat. No	Descriptions
	18900145	1.5ml Centrifuge tube, capacity: 32ea, vertical mount
	18900146	15ml Centrifuge tube, capacity: 16ea, vertical mount
	18900147	50ml Centrifuge tube, capacity: 16ea, vertical mount

Table 5



DLAB Scientific Instrument Inc.

2311 E. Locust Court, Ontario, CA 91761 United States.

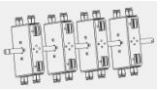
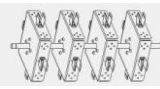
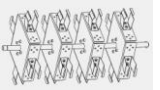
Office: +1-747-230-5179

Fax: +1-909-230-5275

Sales contact: info@dlabsci.com

Service contact: service@dlabsci.com

www.dlabsci.com