

asecos[®]

CX_{LINE} **SLX**_{LINE}

USER MANUAL

Recirculating air filter storage cabinets
ChemFlex



CX-CLASSIC-G



CX.229.105.WDFW



CX.229.081.WDFW



CX229.105.MM.4WD



SLX.230.120.MV



SLX.230.060.MH

IHRE PERSÖNLICHE DOKUMENTATION ZUM asecos-SICHERHEITSSCHRANK

Sehr geehrte Kundin, sehr geehrter Kunde,

mit dem Kauf Ihres asecos-Sicherheitschranks haben Sie eine entscheidende Investition für die Sicherheit in Ihrem Haus getätigt. Vor Ihnen steht ein innovatives Produkt aus hochwertigen Materialien, das höchste Qualität garantiert.

Sicherheitschränke aus dem Hause asecos verfügen über eine lückenlose Zulassungs-Dokumentation. Wir archivieren Ihre Zulassungsdokumente jedes einzelnen Schrankes für Sie, bis Sie diese im Bedarfsfall (z. B. einer Betriebsbegehung o. ä.) mit diesem Formular von uns anfordern.

Dazu einfach dieses Formular heraustrennen/kopieren und mit Ihrer Adresse und der Seriennummer des Schrankes versehen per Fax zurück an uns.

Mit freundlichen Grüßen

asecos GmbH

YOUR PERSONAL DOCUMENTATION TO THE asecos SAFETY CABINET

Dear Customer,

you have made a decisive investment in safety for your company by purchasing this asecos safety storage cabinet. You now own an innovative product made of top-quality materials guaranteeing the highest quality standards.

asecos safety storage cabinets have complete authorisation documents. We archive the authorisation documents for every individual cabinet, keeping them ready for you should you ever need them (e.g. for a works inspection or similar). Simply request them using this form.

Tear off or copy that page and return to us by fax with your address and serial number of the cabinet on it.

Yours sincerely

asecos GmbH

Firma • company	
Abteilung • department	
Name • name	
Straße • street	
PLZ • postal code	
Ort • city	
Schrank • cabinet Seriennummer(n) • serial number(s)	

OPERATING INSTRUCTIONS

Dear customer,

Thank you very much for purchasing a safety storage cabinet from our company, with which you have made a decisive investment in the safety within your company. Our safety storage cabinets make the storage of hazardous materials at the workplace safe and convenient for you.

Please read these operating instructions very carefully. Get to know the advantages and simple operability of our safety storage cabinets in detail. This simplifies the daily handling of hazardous materials for you.

Many thanks.

Your asecos team

INHALTSVERZEICHNIS

1. NOTES · GUIDELINES · GUARANTEE	6
1.1. General safety notes	6
1.2. Guarantee	6
1.3. Cabinet details	6
2. DISPOSAL	7
3. SAFETY CHECKS	7
4. TRANSPORT	8
5. ERECTION OF THE CABINET	8
5.1. Alignment of the cabinets	8
5.2. Anti-tilt device	8
5.3. Assembly of exhaust air vents	9
6. ERECTION OF THE RECIRCULATING AIR FILTER MODULE	9
6.1. Installation	9
6.2. Fall protection of the recirculating air filter module	10
6.3. Potential-free alarmcontact	10
7. COMMISSIONING	11
7.1. Ventilation	11
7.2. Home display and main menu	11
7.3. Change of time and date	11
7.4. Change of system language	11
7.5. Change of system settings	12
7.6. Change of volume flows	12
7.7. Change of advisory alarm	12
8. FILTER CHECK AND FILTER CHANGE	13
8.1. Filter check	13
8.2. Filter change	13
9. INTERIOR FITTINGS	14
9.1. Shelves	14
9.2. Spill containment sump	15
10. TYPES OF CLOSING · LOCKING	15
APPENDIX 1: TECHNICAL DATA	17
APPENDIX 2: TECHNICAL DRAWINGS	19



1.1. GENERAL SAFETY NOTES

- Observe applicable statutes and regulations, and the notes in these operating instructions, when handling hazardous materials.
- Work on the electrical system is to be carried out only with the power turned off and only by qualified electricians – refer here to the regulations of the local electricity supply company.
- The on-site installation conditions are to be observed (e.g. bolting the cabinets to the building).
- The instructions of the supervisory engineering department must be followed.
- Observe accident prevention regulations and workplace ordinance.
- Ensure that necessary safety checks are only carried out by authorised staff using original spare parts.
- Only use the cabinet after having been properly instructed; access is to be forbidden to unauthorised persons.
- The pivoting area of the doors is to be kept free at all times; doors/drawers are to be kept closed.
- By assigning trained/authorised technical personnel you can prevent the malfunctions, damage and corrosion damage that result from inappropriate transport.
- Observe the upper limits for stored quantities, loading etc.
- Containers with a volume larger than that of the spill containment sump may not be placed inside the cabinet; spilt hazardous materials are to be collected immediately and removed.
- Vessels containing aggressive chemicals (acids/alkalis) are to be kept in special cabinets for acids and alkalis or on shelves for acids and alkalis as well as in cabinets with metal-free interior equipment.
- Sufficient technical ventilation must be ensured.
- Before storing such materials, check that the cabinet's surface is resistant to the chemicals.
- The storage of corrosive liquids or gases can affect the function of the shut-off equipment for the air supply and exhaust.
- Before the initial commissioning, the safety storage cabinet is to be examined by the user for possible damage.



1.2. GUARANTEE

The guarantee for this product is agreed between you (the customer) and your dealer (the seller). As the manufacturer, asecos guarantees the products listed in the operating instructions for a period of 24 months from the date of delivery. All model safety equipment are subject to a compulsory annual inspection by specialised staff authorised by the manufacturer. Otherwise the customer's guarantee claim against the manufacturer expires.



PLEASE NOTE!

Only the original asecos accessories and spare parts are accepted! Otherwise the customer's guarantee claim against the manufacturer expires and asecos assumes no liability for potential damage!



1.3. CABINET DETAILS

A complete overview of the models can be found at the start of the operating instructions.

- Cabinet data** ➔ Logbook (included with the cabinet)
- Technical drawing** ➔ Appendix 2
- Technical data** ➔ Table in Appendix 1

CX-LINE

secure storage of chemicals in accordance with regulations (not for the storage of inflammable liquids)

SLX-LINE

secure storage of aggressive liquids in accordance with regulations (not for the storage of inflammable liquids)



The models can be disposed of once they have been dismantled and the materials sorted. They are free from materials that have to be disposed of as special waste.

The cabinets are designed and built in such a way that no significant servicing is required. If safety-relevant damage (such as to the seals in acid and alkali cabinets) is found, the operator must ensure that original parts are used to restore the cabin to good order before it is used again. In order to check the evacuation, take a light piece of fluff or a smoke tube, and check that you can observe a draught inside the cabinet in the area of the outlet opening (on the right of the cabinet or at the rear wall).

In addition, we recommend that you carry out a daily and monthly functional check:

Daily functional check

- applies to the spill containment sumps (collect and remove any leakages)

Monthly functional check

- perfect function of the doors
- regular filter check (see point 8)

In case of damage please contact your dealer in order to have the cabinet repaired using original spare parts. The cabinets can be cleaned with a mild household cleaner and a soft cloth.

CONTACT:

In the case of defects or complaints about our products (within and also after the warranty period), and for requesting safety checks or taking out a service contract, please contact our service hotline on:

Tel: +44 1785 22 70-90

info@asecos.co.uk



4. TRANSPORT

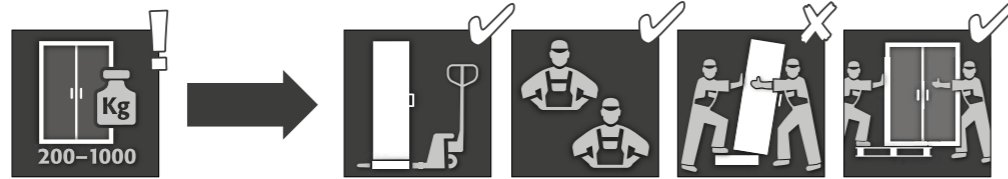

CAUTION:

Transport the cabinet in an upright position on a pallet truck, tied and secured against slipping, until the final place of installation is reached. The transport locks in the door joints may only be removed directly at the place of installation!

Inappropriate transport can lead to concealed damage to the fire protection insulation!

We can only guarantee the necessary quality if the cabinet is transported to the place of its use by our specially trained staff.

Tilting the cabinet (may only be done without jolts)



5. ERECTION OF THE CABINET

5.1. ALIGNMENT OF THE CABINETS

IN GENERAL

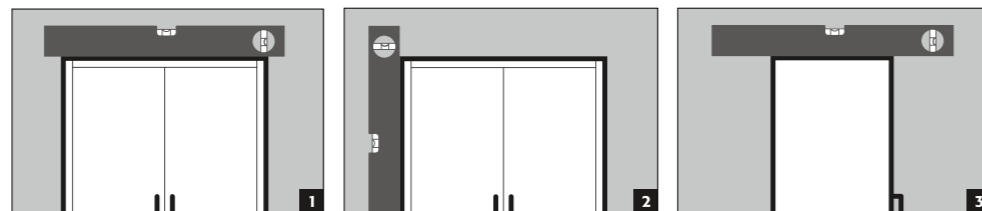

ALL MODELS

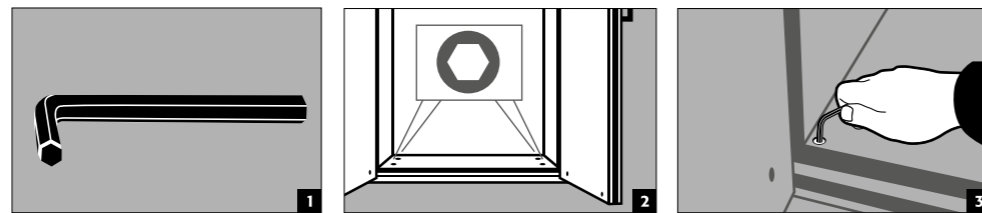

5.2. ANTI-TILT DEVICE

CAUTION:

Use for this the enclosed anti-tilt angle and position this in the middle of the cabinet cover.

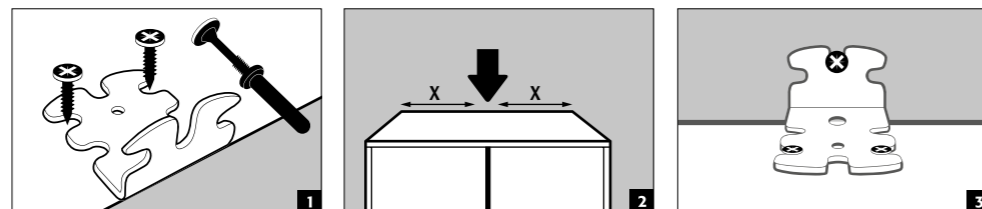

ALTERNATIVE WITH CX-LINE

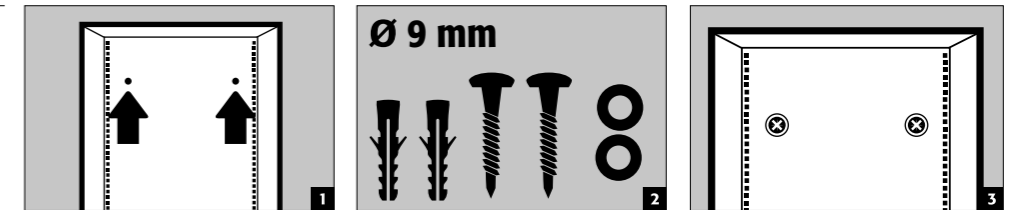

5.3. ASSEMBLY OF EXHAUST AIR VENTS

CX-LINE

(ACCESSORIES INSIDE THE CABINET)

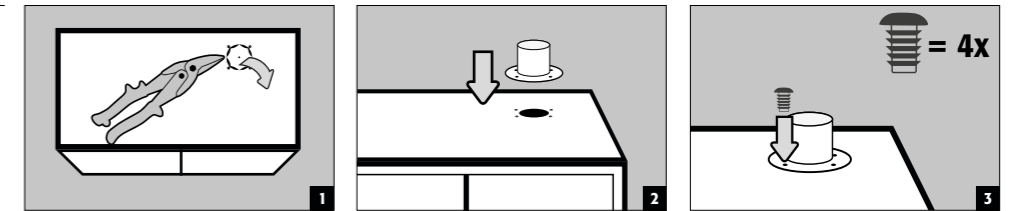

SLX-LINE

(ACCESSORIES INSIDE THE CABINET)

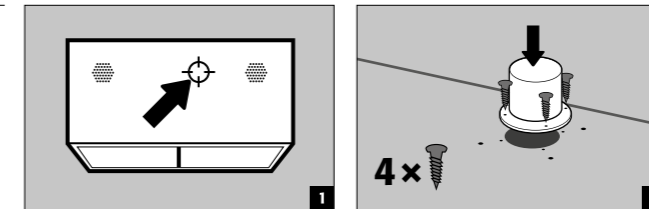

6. ERECTION OF THE RECIRCULATING AIR FILTER MODULE

6.1. INSTALLATION

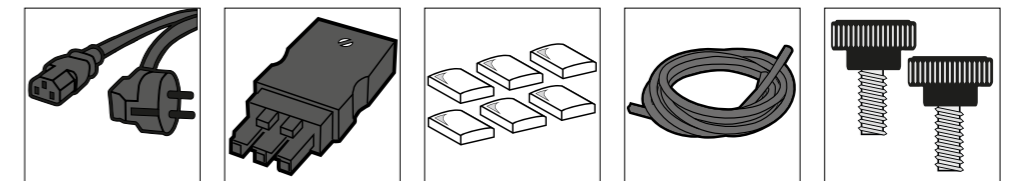

CAUTION:

The cabinet body must be aligned before installing the recirculating air filter module! Place only in pairs the recirculating air filter module on the cabinet body!

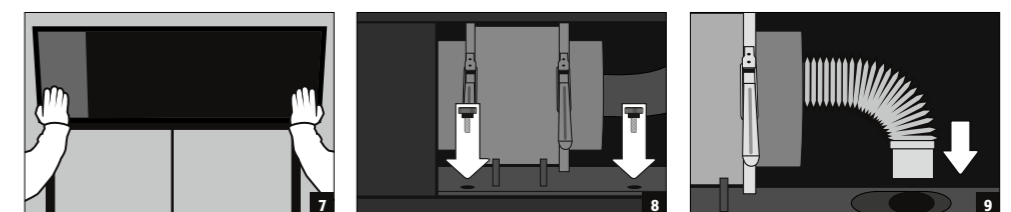
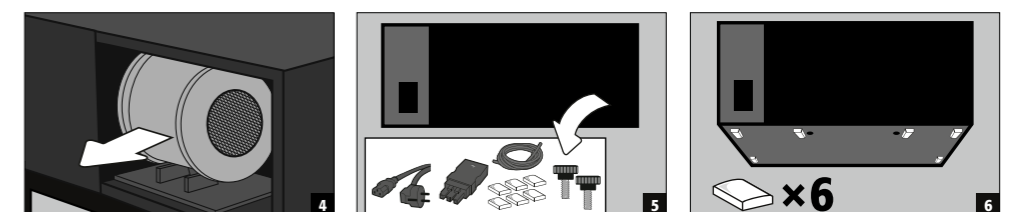
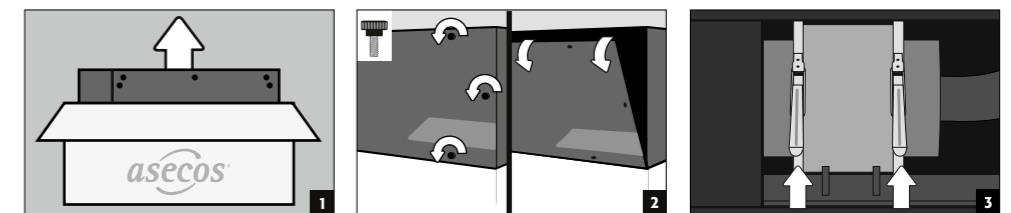

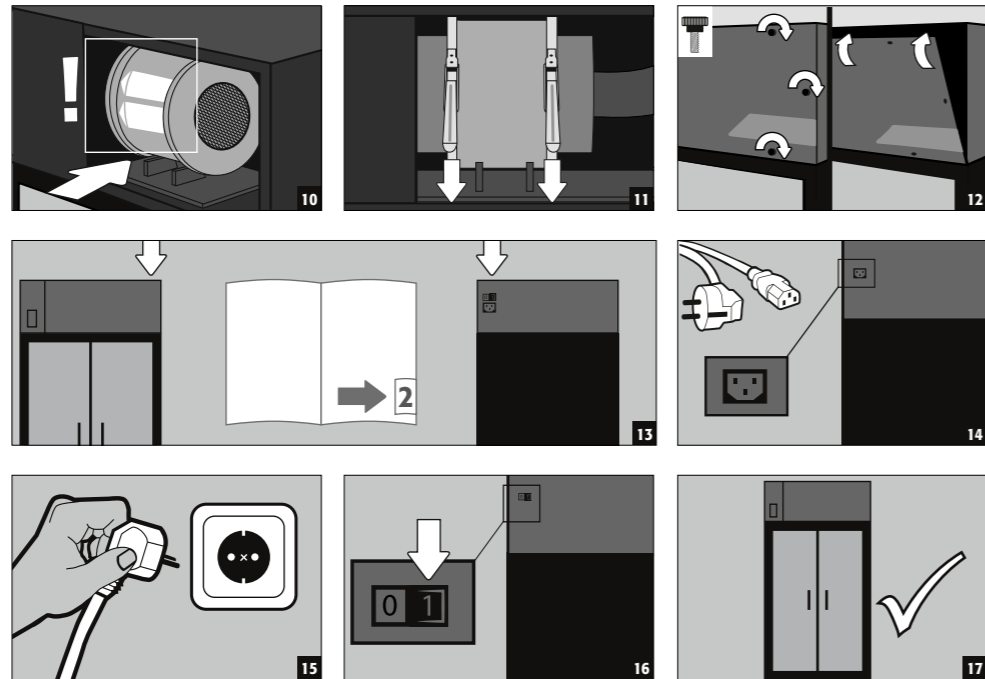

6.2. FALL PROTECTION OF THE RECIRCULATING AIR FILTER MODULE

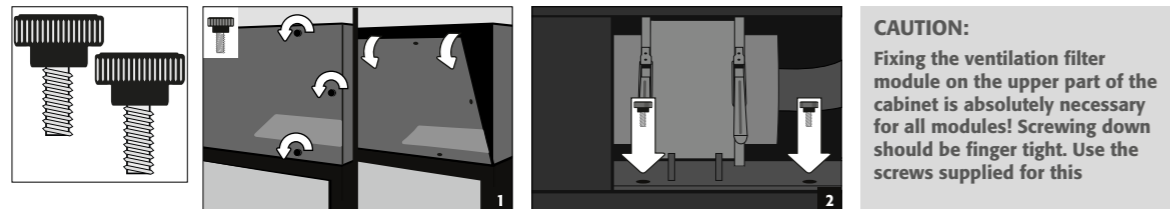

6.3. POTENTIAL-FREE ALARMCONTACT

The three pole connector which is also supplied must be used in order to use the voltage free alarm contact. Only clamps XS3(2) and XS3(1) are normally connected to the connector! Internally a contact will be switched (opened), as soon as the ventilation filter cabinet has reached the prescribed volume flow. If there is a ventilation breakdown or a filter saturation it can therefore be signalled. Furthermore, it will signal if the ventilation filter has been cut off from the mains power.

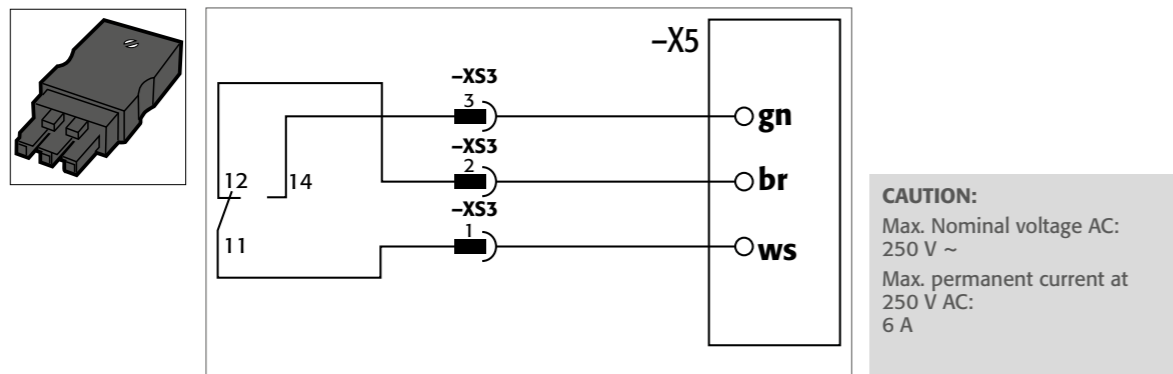

7. COMMISSIONING

- Before putting into operation for the first time, the user must carry out an examination of the safety storage cabinet for possible damage, such as defective or loose sealing elements, correct alignment and perfect functioning of the door elements.
- Use the cabinet and accessories only if they are in an orderly condition

7.1. VENTILATION

- Using the wool thread test the effectiveness of the ventilation and/or the correct connection of the ventilator support to the cabinet supports!

7.2. HOME DISPLAY AND MAIN MENU



7.3. CHANGE OF TIME AND DATE

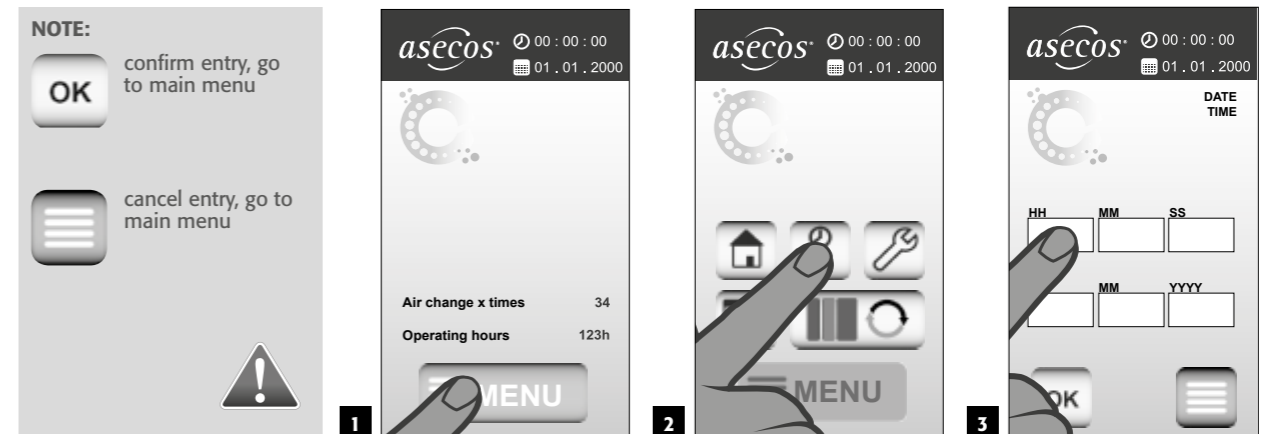

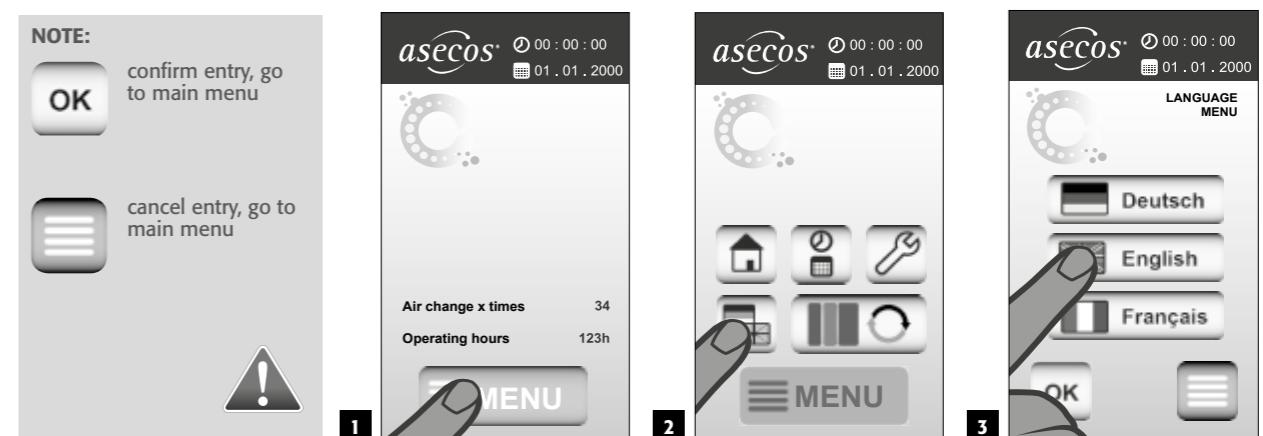

7.4. CHANGE OF SYSTEM LANGUAGE



7.5. CHANGE OF SYSTEM SETTINGS

user=5 / password=1
These values are preset and can only be changed by an asecos service technician.

-  clear the filled out user and password values
-  cancel entry, go to main menu
-  return to service menu



7.6. CHANGE OF VOLUME FLOWS

- NOTE:
-  confirm entry, change to user menu
 -  cancel entry, go to user menu

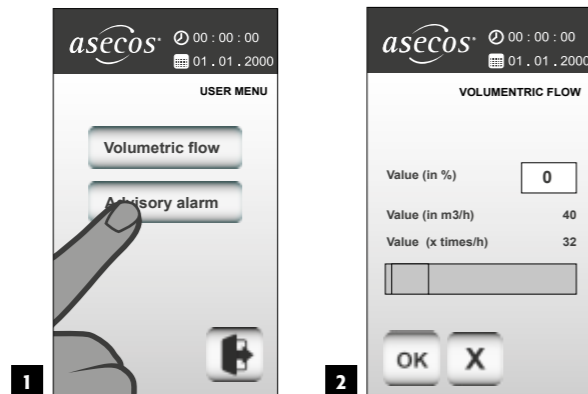

- Volume flows can be adjusted via the slide control or the key pad within a pre-set range.
- The set range depends on the model size

Preset:
≥30 times

7.7. CHANGE OF ADVISORY ALARM

- NOTE:
-  confirm entry, change to user menu
 -  cancel entry, go to user menu

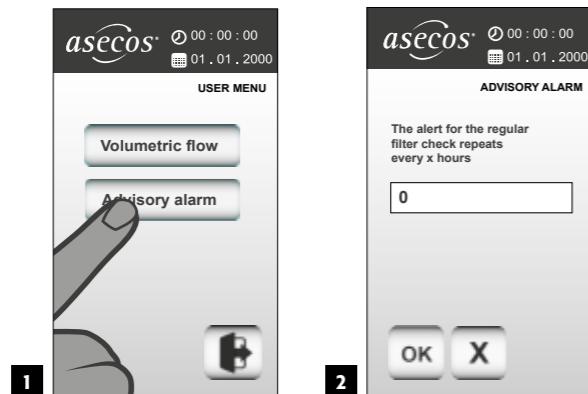

- A minimum of 24 and a maximum of 672 hours can be set.

preset:
336 h

8. FILTER CHECK AND FILTER CHANGE

CAUTION:
The filter saturation must be checked manually at regular intervals.



- Under the touch displays, all ventilation filter cabinets have a device for manually inspecting the filter saturation.
- On the factory site, there is an indicator alarm for the manual filter check every 336 hours (this can be moved in the framework of the risk assessment, see for this Point 7.7)
- In the delivery scope, there is a 1m long hose line suitable for commercially available inspection tubes (for instance, Dräger) including an adaptor suitable for the withdrawal equipment.

8.1. FILTER CHECK

- Please connect the hose included. Adaptor with withdrawal equipment and an empty or used inspection tube included. Gas detection pump.
- In order to remove the dead volume of the hose, first of all a hub with an empty or an already used inspection tube is implemented.
- Immediately afterwards use the correct inspection tube and implement the test according to the instructions of the testing equipment manufacturer.
- If the measurement results approach the limit value according to your risk assessment, a filter change should be initiated, at latest however when the WEL (Workplace Exposure Limit according to the Technical Rule for Hazardous Materials TRGS900 or the Safety Data sheet of the Medium)

8.2. FILTER CHANGE

Each filter of the ventilation cabinets is matched according to the size and characteristics of the cabinet model and the intended passive storage therein (according to positive material list). The filter must be changed after a more substantial leakage and at latest after 8640 operational hours (12 months).

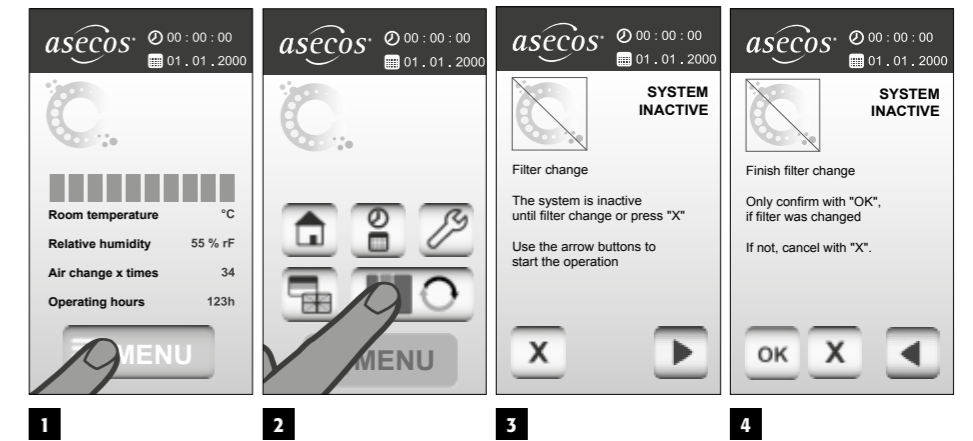

Follow the instructions on the display!

PLEASE NOTE!

Only the original asecos accessories and spare parts are accepted!
Otherwise the customer's guarantee claim against the manufacturer expires and asecos assumes no liability for potential damage!

9. INTERIOR FITTINGS

9.1. SHELVES



CAUTION:

When adjusting the shelves, ensure that no containers are resting on the shelf so that they cannot be pushed over or damaged by the modification work in the cabinet.

CX-LINE

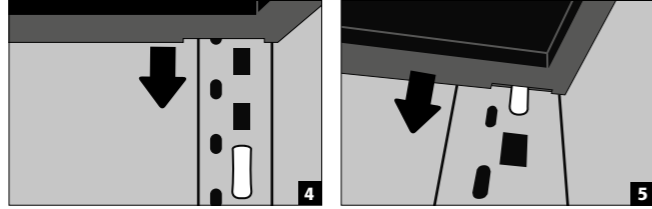
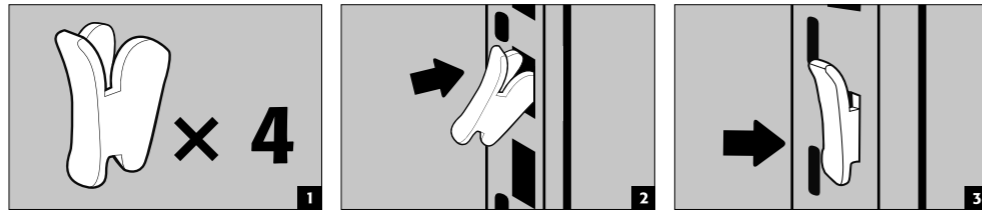
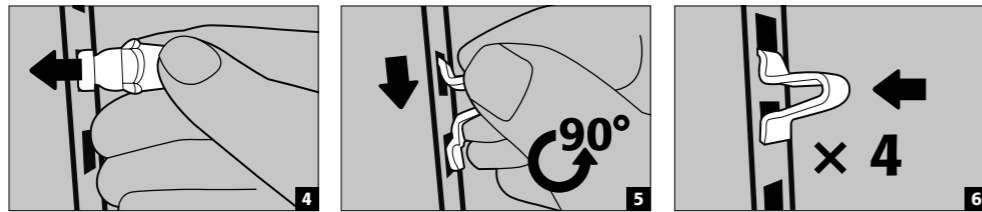
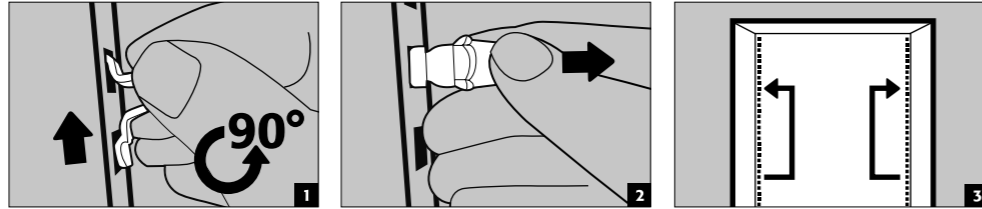

CX-LINE
SLX-LINE

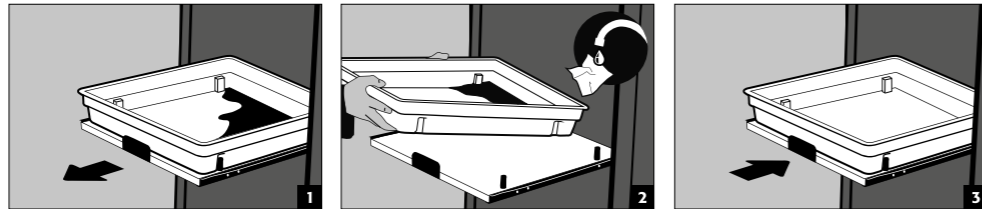

ACHTUNG:

Die Tablarauzüge sind fest im Schrank eingebaut und besitzen eine Ausziehsicherung. Sie müssen nach Benutzung per Hand in den Schrank eingeschoben werden.

9.2. SPILL CONTAINMENT SUMP



CAUTION:

The individual volumes that can be collected can be found in the table of technical data in the appendix.

CX-LINE

- It is the purpose of the spill containment sump to collect any liquids that might escape inside the cabinet.

SLX-LINE

- Plastic sumps, impervious to liquids, at each storage level for trapping any liquid leaks

10. TYPES OF CLOSING - LOCKING

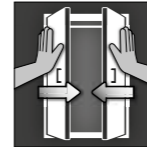

CAUTION:

Make sure that the door(s) are always closed again after use. The door is/doors are always locked by hand.



CX-LINE



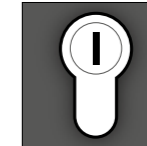











- the cabinets are lockable by means of safety cylinders



SLX-LINE









- are available with profile lock



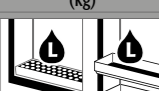

APPENDIX 1: TECHNICAL DATA

				 Int.			 min.		 max.	 max.*								
	X	Y	Z	X	Y	Z											m ³ /h Δp_{ges} (EK5/AK4 09-10)	m ³ /h Δp_{ges} (EK5/AK4 09-10)
CX.229.105.WDFW	1055	520	2290	996	493	1835	—	105	600	440	100	30	33	34	30	30,91	—	—
CX.229.081.WDFW	810	520	2290	751	493	1835	—	93	600	536	60	30	33	25	30	22,73	—	—
CX.229.105.MM.4WD	1055	520	2290	475/475	493	905/905	—	98	600	435	50	30	22	15	20	13,64	—	—
SLX.230.120.MV	1197	615	2300	485/485	565	1865	—	195	300	204	—	25	30	18	27,27	16,36	—	—
SLX.230.060.MH.(MHR)	600	615	2300	485	565	914/914	—	152	300	363	—	25	30	18	27,27	16,36	—	—

Legende für Tabelle „Technische Daten“
Key for “Technical data” table
Legende voor tabel „Technische gegevens“

Légende du tableau « Caractéristiques techniques »
Leyenda de la tabla “Datos técnicos”
Legenda per tabella “Dati tecnici”
Legenda para a tabela “Dados técnicos”

	DE	EN	NL	FR	ES	IT	PT
	Abmessungen	Dimensions	Afmetingen	Dimensions	Dimensiones	Dimensioni	Dimensões
(mm)							
	Typklasse	Type-Classification	Typeklasse	Type de classe	Clase tipo	Classe del tipo	Tipo de classe
min.							
	Leergewicht gesamt	Net Weight	Leeggewicht totaal	Poids total à vide	Peso en vacío total	Peso a vuoto completo	Peso total em vazio
(kg)							
	Max. Belastung	max. Load Cabinet	max. belasting	Chargement max.	Carga máx	Carico max.	Carga máx.
(kg)							
	Flächenlast	Area Load	Oppervlaktebelasting	Charge superficielle	Carga superficial	Carico specifico	Carga da superfície
(kg/ m ²)							
	Max. Belastung Fachboden	max. Load Shelf	max. belasting opvanglegbord	Charge max. d'étagère	Carga máx. bandeja	Carico max. ripiano fisso	Carga máx. da prateleira
(kg)							
	Max. Belastung Auszug	max. Load Drawer	max. belasting schuiflade	Charge max. de tiroir	Carga máx. cajón	Carico max. cassetto	Carga máx. do extrato
(kg)							
	Auffangvolumen Bodenauffangwanne und Auszug	Capacity Bottom collecting sump and Drawer	Opvangcapaciteit bodemopvangbak en schuiflade	Volume de rétention de bac de rétention au sol et tiroir	Volumen de recogida del cubeto de retención y del cajón	Volume di raccolta vasca di raccolta sul fondo e cassetto	Volume de recolha da bacia de retenção inferior e extrato
(l)							
	Max. Gebindegröße Bodenauffangwanne und Auszug	max. container size bottom collecting sump and drawer	max. containergrootte bodemopvangbak en schuiflade	Taille max. de récipient pour bac de rétention au sol et tiroir	Tamaño máx. de envase cubeto de retención y cajón	Grandezza max. del recipiente vasca di raccolta sul fondo e cassetto	Tamanho máx. do bidão da bacia de retenção inferior e extrato
(l)							

	DE	EN	NL	FR	ES	IT	PT
	Volumen und Druckverlust bei 10fachen Luftwechsel	Air flow and Pressure Loss at 10times Air change	volumen en drukverlies bij 10-voudige luchtverversing	volume et perte de pression avec un taux de renouvellement de l'air de 10	Volumen y caída de presión con renovación de aire de 10 veces	Volume e perdita di pressione con decuplo cambio dell'aria	Volume e perda de pressão até 10 vezes a renovação de ar
(m ³ /h, Pa)							
	Volumen und Druckverlust bei 120fachen Luftwechsel	Air flow and Pressure Loss at 120times Air change	volumen en drukverlies bij 120-voudige luchtverversing	volume et perte de pression avec un taux de renouvellement de l'air de 120	Volumen y caída de presión con renovación de aire de 120 veces	Volume e perdita di pressione con centoventesimo cambio dell'aria	Volume e perda de pressão até 120 vezes a renovação de ar
(m ³ /h, Pa)							
	Sicherheitsschränke EN 14470-1	Safety storage cabinets EN 14470-1	Veiligheidskasten EN 14470-1	Armoires de sécurité EN 14470-1	Armarios de seguridad EN 14470-1	Armadi di sicurezza EN 14470-1	Armários de segurança EN 14470-1
EN 14470-1							
	Kombischränke Säuren und Laugen/ EN 14470-1	Combined cabinets acids and alkalis/ EN 14470-1	Combinatiekasten zuren en logen/ EN 14470-1	Armoires combinées	Armarios combinados	Armadi combinati	Armários combinados para ácidos e lixívias
EN 14470-1							
	Sicherheitsschränke EN 14470-2	Safety storage cabinets EN 14470-2	Veiligheidskasten EN 14470-2	Armoires de sécurité EN 14470-2	Armarios de seguridad EN 14470-2	Armadi di sicurezza EN 14470-2	Armários de segurança EN 14470-2
EN 14470-2							

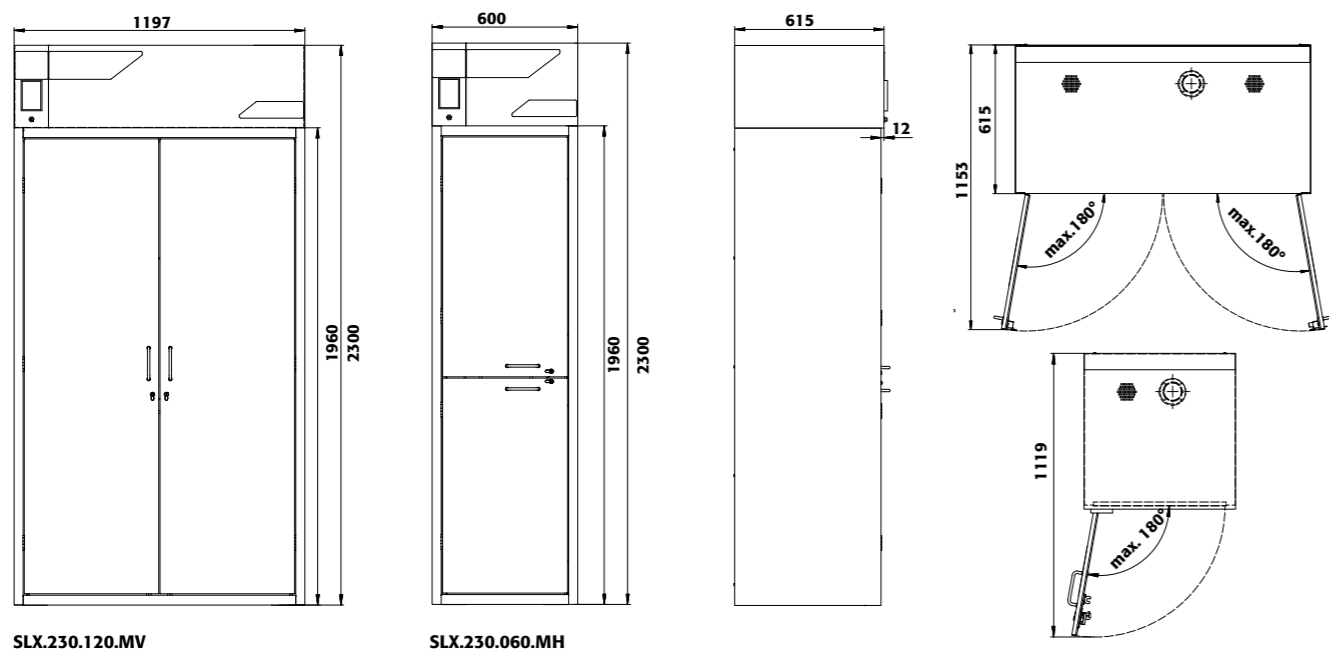
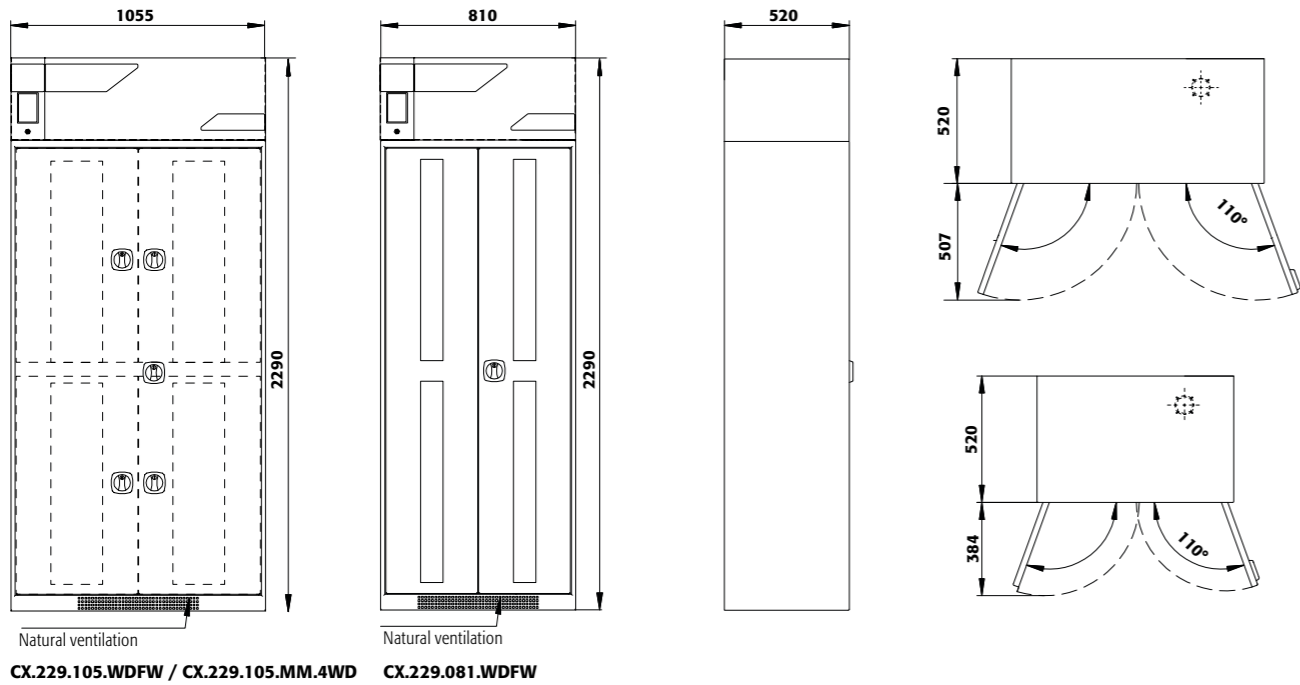

asecos GmbH
Abt. Kundendienst
Weiherfeldsiedlung 16-18
D-63584 Gründau
Fax: +49 60 51 – 92 20-10

www.asecos.com

Ihr Fachhändler:

Your partner:

Uw partner:

Votre partenaire :

Su distribuidor:

su richiesta: