



Overview: model class S-CLASSIC-90

Safe and approved storage of flammable hazardous substances in working areas



Proven all-rounder

- our first EN compliant safety storage cabinet
- decades of developing and optimising ensure that the S-CLASSIC-90 is technically sophisticated



Large range of models

- available in three widths (60, 90, 120 cm) and two heights (129, 169 cm)
- door open arrest system optional



BEST PRICE

- our most cost-effective type 90 tall cabinet
- versatile fields of application due to various interior equipment

Further features of this model class



Convenient handling

- door operation with minimal effort
- door open arrest system (optional) allows convenient and safe removal or storage of containers with both hands



Cylinder lock

- door lockable with cylinder lock, the cabinets can be integrated by the customer in an existing locking system



Comfortable adjusting possibilities

- integrated adjusting aids in the cabinet base ensure a fast and effective compensation for uneven floor of up to 10 mm

Possible interior equipment



- **metal-free interior equipment** for the storage of aggressive hazardous materials
- as standard with **removable plastic sump**



- **drawers** with high storage volumes, ideal for storing small containers



- **height-adjustable shelves** in different versions



- **bottom collecting sump** – safe collection of leakages
- usable as storage level in conjunction with perforated insert



Safety storage cabinets for unrestricted storage of flammable hazardous materials in work areas in accordance with EN 14470-1 and TRGS 510



CLASSIC



- **fire resistance of 90 minutes** (type 90), type-tested in accordance with EN 14470-1



- **GS-tested** (EN 14470-1, EN 14727, document EK5/AK4 09-10, ProdSG)
- **50,000** wear-free opening and closing actions
- test basis: all cabinets of this model group correspond to the requirements of the Equipment and Product Safety Act (§7 Para. 1) with respect to the guarantee of safety and health



- **excellent products with special manufacturer warranty**
- extended **manufacturer warranty of up to 5 years** in combination with the asecos BASICPlus tariff



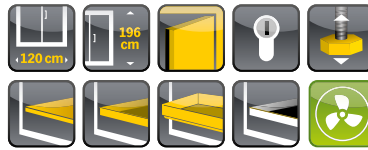

Safe and approved storage of flammable hazardous substances in working areas

Function / construction:

- **robust construction and longevity:** triple hinged door, body made of powder-coated sheet steel, safety elements assembled outside the cabinet for increased protection against corrosion
- **user-friendly and safe (model .WDAS):** door open arrest system, convenient and safe removal or storage of containers
- **no unauthorised use:** doors lockable with profile cylinder (integration in an existing locking system possible)
- **easy alignment:** adjusting aids to compensate for uneven floor

- **ventilation:** integrated air ducts ready for connection (DN 75) to a technical exhaust system

Available equipment

- shelves with load capacity of 75 kg
- tray shelves with load capacity of 150 kg
- perforated insert useable as storage area
- bottom collecting sump
- drawers – high storage capacity, optimal use of the available storage capacities
- drawers heavy-duty with load capacity of 100 kg
- metal-free tray shelves and collecting sumps
- storage box
- sump inliner (PE or PP)

Safety storage cabinet S-CLASSIC-90 model S90.196.120

in Warning yellow (RAL 1004), interior equipment with 3 x shelf, 1 x perforated insert, 1 x bottom collecting sump (sheet steel powder-coated)

Order No. 30115-002-33715

(recirculating air filter system optional)



Drawers

High storage capacity
Ideal for the storage of small containers



Metal-free interior equipment

Ideal for the storage of flammable, aggressive hazardous substances. Tray shelves with chemical resistant surface lamination and removable plastic sump, bottom collecting plastic sump.



Extraction unit

Safe ventilation of safety storage cabinets

plug-in – fast and easy to install

Further information and products from page 397

Order No. 14218



Shelf

Height adjustable (32 mm increments), with 30 mm upstand



Adjusting aids

To compensate for uneven floor and an easy alignment



Recirculating air filter system

Avoid complex wall break-throughs and expensive extraction piping

Further information from page 393

Order No. 25099



Safety storage cabinet

S-CLASSIC-90 model S90.196.120.WDAS

in Warning yellow (RAL 1004), interior equipment with 4 x drawer (sheet steel powder-coated)

Order No. 30116-002-33724

(extraction unit optional)

Safety storage cabinet

S-CLASSIC-90 model S90.196.120.WDAS

in Light grey (RAL 7035), interior equipment with 6 x drawer (sheet steel powder-coated)

Order No. 30116-001-33726

2 door colours are available **at no extra cost:**

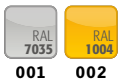

001 002

PLEASE NOTE: interior equipment with drawers can only be ordered in combination with WDAS cabinets

Order example - how to order correctly



Model	Information / equipment	Order No.
S90.196.120	without interior equipment	30115
S90.196.120.WDAS	without interior equipment	30116

Body colour	Door colour	Order No.
Light grey RAL 7035	Light grey RAL 7035	001
Warning yellow RAL 1004	Warning yellow RAL 1004	002























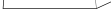

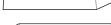







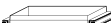

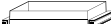









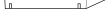



Interior equipment packages (can only be ordered in combination with the cabinet)	Material	Order No.
		old code new code
3x shelf, 1x perforated insert, 1x bottom collecting sump (V=33.0L)	sheet steel powder-coated RAL 7035	30127 33715
4x shelf, 1x perforated insert, 1x bottom collecting sump (V=33.0L)	sheet steel powder-coated RAL 7035	30128 33716
3x shelf, 1x bottom collecting sump (V=33.0L)	sheet steel powder-coated RAL 7035	30130 33717
4x shelf, 1x bottom collecting sump (V=33.0L)	sheet steel powder-coated RAL 7035	30131 33718
3x tray shelf (V=33.0L), 1x perforated insert, 1x bottom collecting sump (V=55.5L)	sheet steel powder-coated RAL 7035	30133 33719
3x shelf, 1x perforated insert, 1x bottom collecting sump (V=33.0L)	stainless steel	30135 33720
4x shelf, 1x perforated insert, 1x bottom collecting sump (V=33.0L)	stainless steel	30136 33721
3x shelf, 1x bottom collecting sump (V=33.0L)	stainless steel	30138 33722
4x shelf, 1x bottom collecting sump (V=33.0L)	stainless steel	30139 33723
3x tray shelf (V=33.0L), 1x bottom collecting sump (V=33.0L)	PP grey	HIGHLIGHT 30143 30143
4x tray shelf (V=33.0L), 1x bottom collecting sump (V=33.0L)	PP grey	HIGHLIGHT 30144 30144
4x drawer (V=30.0L)	sheet steel powder-coated RAL 7035	30147 33724
5x drawer (V=30.0L)	sheet steel powder-coated RAL 7035	30148 33725
6x drawer (V=30.0L)	sheet steel powder-coated RAL 7035	30149 33726
4x drawer (V=30.0L)	stainless steel	30152 33727
5x drawer (V=30.0L)	stainless steel	30153 33728
6x drawer (V=30.0L)	stainless steel	30154 33729



Individual configuration of model S90.196.120 / S90.196.120.WDAS

 Model	Information / equipment	W x D x H (mm)	Order No.
S90.196.120	without interior equipment	1196 x 616 x 1968	30115
S90.196.120.WDAS	without interior equipment	1196 x 616 x 1968	30116

 Body colour	Door colour	Order No.
Light grey RAL 7035	Light grey RAL 7035	001 
Warning yellow RAL 1004	Warning yellow RAL 1004	002 

 Interior equipment	Material	W x D x H (mm)	 1)	 2)	 3)	Order No.	
						old code	new code
 shelf	sheet steel powder-coated RAL 7035	1040 x 432 x 30*	75.00			30021	30021 
	stainless steel	1038 x 425 x 29*	75.00			30024	30024 
 tray shelf	sheet steel powder-coated RAL 7035	1025 x 445 x 71*	150.00	33.00	30.00	30028	30028 
	stainless steel	1025 x 445 x 71*	150.00	33.00	30.00	30064	30064 
 tray shelf, metal-free	PP grey	1002 x 472 x 74*	50.00	33.00	30.00	30027	30027 
 perforated insert	sheet steel powder-coated RAL 7035	1024 x 417 x 60	75.00			5536	5536 
	stainless steel	1024 x 417 x 60	75.00			5773	5773 
 perforated insert, height = 135 mm	sheet steel powder-coated RAL 7035	1024 x 417 x 135	135.00			14084	14084 
 bottom collecting sump	sheet steel powder-coated RAL 7035	1024 x 489 x 86*		33.00	30.00	30022	33634 
	stainless steel	1024 x 489 x 86*	150.00	33.00	30.00	30025	33641 
 bottom collecting sump, V = 55,5 ltr.	sheet steel powder-coated RAL 7035	1017 x 482 x 127*		55.50	50.45	30023	33639 
	stainless steel	1018 x 438 x 120*		55.50	50.00	30026	30026 
 bottom collecting sump, metal-free	PP grey	1002 x 472 x 74*		33.00	30.00	26989	26989 
 drawer	sheet steel powder-coated RAL 7035	844 x 488 x 90*	60.00	30.00	2727	30013	33646 
	stainless steel	844 x 488 x 90*	60.00	30.00	2727	30033	33650 
 drawer (heavy-duty)	sheet steel powder-coated RAL 7035	843 x 487 x 162*	100.00	66.00		30032	30032 
	stainless steel	843 x 487 x 162*	100.00	66.00		30034	30034 
 storage box, left hinged	sheet steel powder-coated RAL 7035	380 x 420 x 360				30029	30029 
 storage box, right hinged	sheet steel powder-coated RAL 7035	380 x 420 x 360				30030	30030 
 sump inliner, for shelf	polyethylene black	1000 x 392 x 50*				7223	7223 
 sump inliner, for drawer	PP grey	834 x 450 x 96*				10054	10054 
 anti-slip rubber mat, for drawer	black	840 x 490 x 1				8699	8699 
 pipe lead-through	sheet steel powder-coated RAL 7035	182 x 104 x 48				30035	30035 
 box for chemicals	PP blue	410 x 300 x 260		18.00	16.36	30038	30038 
 transport base, height = 118 mm	steel powder-coated RAL 7035	1195 x 610 x 118				30171	30171 
 document holder, DIN A5	polystyrene					30793	30793 

 Accessories	Order No.
recirculating air filter system with exhaust air monitoring	25099 
extraction unit without exhaust air monitoring	14218 

* usable storage space W x D [mm]

1) load capacity [kg], 2) retention capacity [ltr], 3) maximum container volume in the cabinet [ltr]

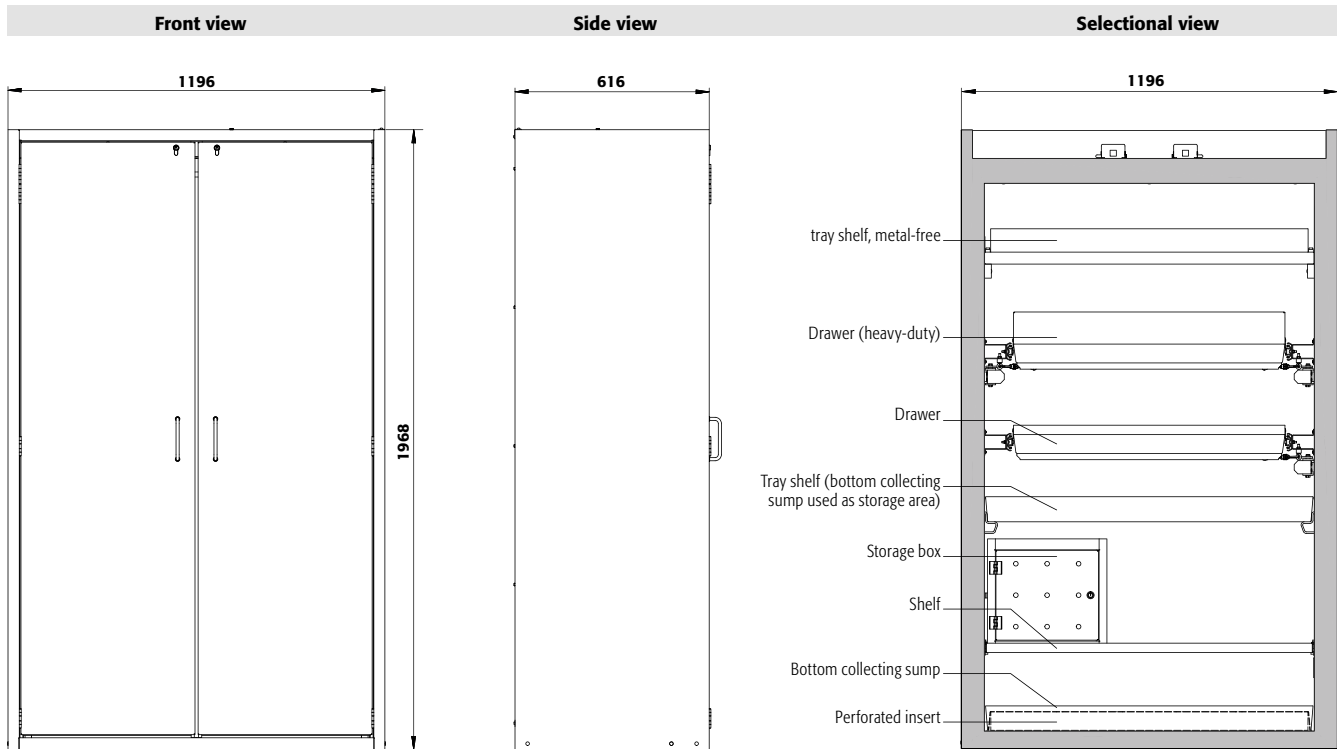

Technical data

S90.196.120(WDAS)

External dimensions W x D x H	mm	1196 x 616 x 1968
Internal dimensions W x D x H	mm	1050 x 524 x 1742
Weight without interior equip.	kg	420
Air change 10 times	m ³ /h	10
Diff. pressure (air change 10 times EK5/AK4)	Pa	5
Diff. pressure (air change 10 times)	Pa	5
Maximum load	kg	600
Distributed load	kg/m ²	528

Transport base optional

Entry height	mm	100
Entry width	mm	2 x 440

Top view

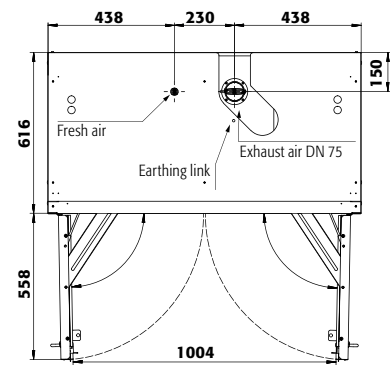

S90.196.120(WDAS)

Drawers/number

	9	8	7	6	5	4+1	4	3	2
Distance ⑨ (mm)	150								
Distance ⑧ (mm)	135	210							
Distance ⑦ (mm)	135	200	210						
Distance ⑥ (mm)	135	170	200	275					
Distance ⑤ (mm)	170	170	200	230	340	275			
Distance ④ (mm)	170	170	200	230	295	230	405		
Distance ③ (mm)	170	170	200	230	295	230	360	530	
Distance ② (mm)	170	170	230	230	295	295	390	520	980
Distance ① (mm)	200	200	230	295	295	490	390	550	615

Standard storage heights of the drawers

S90.196.120(WDAS)

Shelves/number

	4	3
Distance ④ (mm)	320	
Distance ③ (mm)	350	420
Distance ② (mm)	350	450
Distance ① (mm)	290	380

Standard storage heights of the shelves

S90.196.120(WDAS)

Quantity

Quantity	Type of container	Container size
90	Aerosol cans	400 ml
40	Cans	1 litre
40	Laboratory glass bottles	1 litre
40	Laboratory PE-bottles	1 litre
15	Laboratory glass bottles	2.5 litres

Storage capacities per drawer/type of container

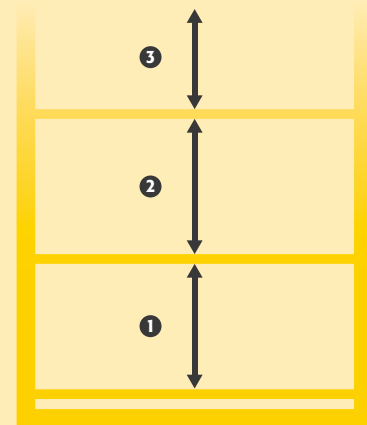

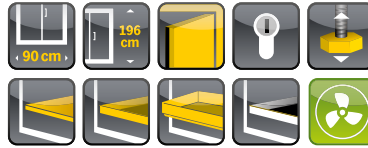

Safe and approved storage of flammable hazardous substances in working areas

Function / construction:

- **robust construction and longevity:** triple hinged door, body made of powder-coated sheet steel, safety elements assembled outside the cabinet for increased protection against corrosion
- **user-friendly and safe (model .WDAS):** door open arrest system, convenient and safe removal or storage of containers
- **no unauthorised use:** doors lockable with profile cylinder (integration in an existing locking system possible)
- **easy alignment:** adjusting aids to compensate for uneven floor

- **ventilation:** integrated air ducts ready for connection (DN 75) to a technical exhaust system

Available equipment

- shelves with load capacity of 75 kg
- tray shelves with load capacity of 150 kg
- perforated insert useable as storage area
- bottom collecting sump
- drawers – high storage capacity, optimal use of the available storage capacities
- drawers heavy-duty with load capacity of 100 kg
- metal-free tray shelves and collecting sumps
- storage box
- sump inliner (PE or PP)

Safety storage cabinet S-CLASSIC-90 model S90.196.090

in Warning yellow (RAL 1004), interior equipment with 3 x shelf, 1 x perforated insert, 1 x bottom collecting sump (sheet steel powder-coated)

Order No. 30204-002-33705

(extraction unit optional)



User-friendly and safe

Door open arrest system (optional), convenient and safe removal or storage of containers



Metal-free interior equipment

Ideal for the storage of flammable, aggressive hazardous substances. Tray shelves with chemical resistant surface lamination and removeable plastic sump, bottom collecting plastic sump.

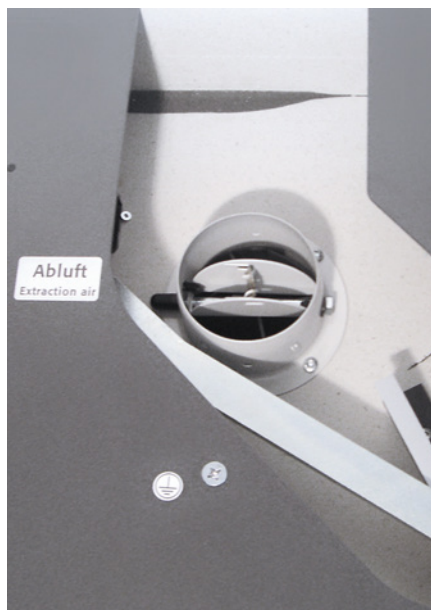

Quickly put into operation

Integrated air ducts ready for connection (DN 75) to a technical exhaust system



Extraction unit

Safe ventilation of safety storage cabinets

plug-in – fast and easy to install

Further information and products from page 397

Order No. 14218



Recirculating air filter system

Avoid complex wall break-throughs and expensive extraction piping

Further information from page 393

Order No. 25099



Safety storage cabinet

S-CLASSIC-90 model S90.196.090.WDAS

in Light grey (RAL 7035), interior equipment with 4 x drawer (sheet steel powder-coated)

Order No. 30205-001-33709

Safety storage cabinet

S-CLASSIC-90 model S90.196.090.WDAS

in Warning yellow (RAL 1004), interior equipment with 6 x drawer (sheet steel powder-coated)

Order No. 30205-002-33711

2 door colours are available **at no extra cost:**

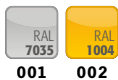

Model

Model	Information / equipment	Order No.
S90.196.090	without interior equipment	30204
S90.196.090.WDAS	without interior equipment	30205



Body colour

Body colour	Door colour	Order No.
Light grey RAL 7035	Light grey RAL 7035	001
Warning yellow RAL 1004	Warning yellow RAL 1004	002



Interior equipment packages (can only be ordered in combination with the cabinet)

	Material	Order No.	
		old code	new code
3x shelf, 1x perforated insert, 1x bottom collecting sump (V=22.0L)	sheet steel powder-coated RAL 7035	30208	33705
4x shelf, 1x perforated insert, 1x bottom collecting sump (V=22.0L)	sheet steel powder-coated RAL 7035	30209	33706
3x shelf, 1x bottom collecting sump (V=22.0L)	sheet steel powder-coated RAL 7035	30210	33707
4x shelf, 1x bottom collecting sump (V=22.0L)	sheet steel powder-coated RAL 7035	30211	33708
3x shelf, 1x perforated insert, 1x bottom collecting sump (V=22.0L)	stainless steel	30212	33709
4x shelf, 1x perforated insert, 1x bottom collecting sump (V=22.0L)	stainless steel	30213	33710
3x shelf, 1x bottom collecting sump (V=22.0L)	stainless steel	30214	33711
4x shelf, 1x bottom collecting sump (V=22.0L)	stainless steel	30215	33712
3x tray shelf (V=22.0L), 1x bottom collecting sump (V=22.0L)	PP grey	HIGHLIGHT 30216	30216
4x tray shelf (V=22.0L), 1x bottom collecting sump (V=22.0L)	PP grey	HIGHLIGHT 30217	30217
4x drawer (V=19.0L)	sheet steel powder-coated RAL 7035	30218	33709
5x drawer (V=19.0L)	sheet steel powder-coated RAL 7035	30219	33710
6x drawer (V=19.0L)	sheet steel powder-coated RAL 7035	30220	33711
4x drawer (V=19.0L)	stainless steel	30221	33712
5x drawer (V=19.0L)	stainless steel	30222	33713
6x drawer (V=19.0L)	stainless steel	30223	33714

PLEASE NOTE: interior equipment with drawers can only be ordered in combination with WDAS cabinets

Order example - how to order correctly





Individual configuration of model S90.196.090 / S90.196.090.WDAS



Model	Information / equipment	W x D x H (mm)	Order No.
S90.196.090	without interior equipment	896 x 616 x 1968	30204
S90.196.090.WDAS	without interior equipment	896 x 616 x 1968	30205



Body colour	Door colour	Order No.
Light grey RAL 7035	Light grey RAL 7035	001
Warning yellow RAL 1004	Warning yellow RAL 1004	002



Interior equipment	Material	W x D x H (mm)	1)	2)	3)	Order No.
						old code new code
shelf	sheet steel powder-coated RAL 7035	740 x 432 x 30*	75.00			30059 30059
	stainless steel	740 x 432 x 30*	75.00			30061 30061
tray shelf, metal-free	PP grey	702 x 472 x 74*	50.00	23.00	20.91	30063 30063
perforated insert	sheet steel powder-coated RAL 7035	742 x 417 x 70	75.00			11165 11165
	stainless steel	742 x 417 x 70	75.00			11168 11168
bottom collecting sump	sheet steel powder-coated RAL 7035	724 x 489 x 83*		22.00	20.00	30060 33621
	stainless steel	724 x 489 x 83*		23.00	20.91	30062 30062
bottom collecting sump, metal-free	PP grey	702 x 472 x 74*		23.00	20.91	26990 26990
drawer	sheet steel powder-coated RAL 7035	544 x 488 x 90*	60.00	19.00	17.27	30065 33626
	stainless steel	544 x 488 x 90*	60.00	19.00	17.27	30067 33630
drawer (heavy-duty)	sheet steel powder-coated RAL 7035	543 x 487 x 162*	100.00	45.00		30066 30066
	stainless steel	543 x 487 x 162*	100.00	45.00		30068 30068
storage box, left hinged	sheet steel powder-coated RAL 7035	380 x 420 x 360				30029 30029
storage box, right hinged	sheet steel powder-coated RAL 7035	380 x 420 x 360				30030 30030
sump inliner, for drawer	polyethylene white	536 x 480 x 90*		22.00	20.00	27948 27948
sump inliner, for shelf	PP grey	653 x 406 x 88*				9707 9707
anti-slip rubber mat, for drawer	black	540 x 490 x 1				15653 15653
pipe lead-through	sheet steel powder-coated RAL 7035	182 x 104 x 48				30035 30035
box for chemicals	PP blue	410 x 300 x 260		18.00	16.36	30038 30038
transport base, height = 118 mm	steel powder-coated RAL 7035	895 x 610 x 118				30224 30224
document holder, DIN A5	polystyrene					30793 30793



Accessories	Order No.
recirculating air filter system with exhaust air monitoring	25099
extraction unit without exhaust air monitoring	14218

* usable storage space W x D (mm)

1) load capacity [kg], 2) retention capacity [ltr], 3) maximum container volume in the cabinet [ltr]

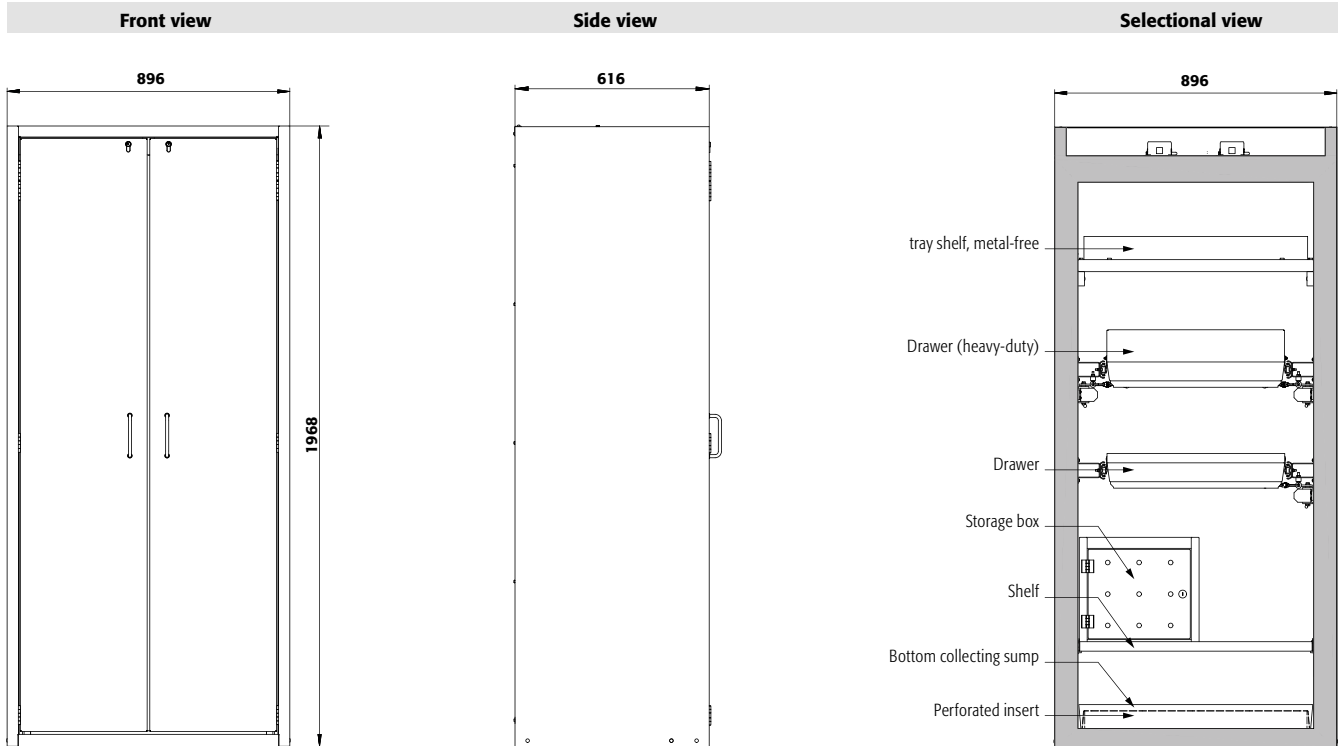

Technical data

S90.196.090(WDAS)

External dimensions W x D x H	mm	896 x 616 x 1968
Internal dimensions W x D x H	mm	750 x 524 x 1742
Weight without interior equip.	kg	310
Air change 10 times	m ³ /h	7
Diff. pressure (air change 10 times EK5/AK4)	Pa	5
Diff. pressure (air change 10 times)	Pa	5
Maximum load	kg	600
Distributed load	kg/m ²	628

Transport base optional

Entry height	mm	100
Entry width	mm	2 x 290

Top view

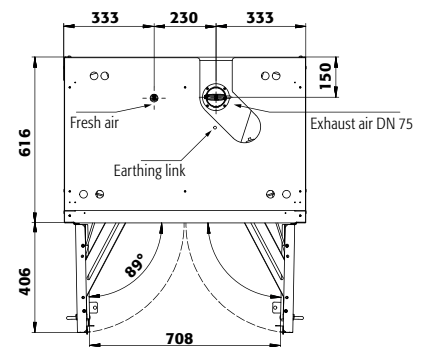

S90.196.090(WDAS)

Drawers/number	9	8	7	6	5	4+1	4	3	2
Distance ⑨ (mm)	135								
Distance ⑧ (mm)	135	200							
Distance ⑦ (mm)	135	200	200						
Distance ⑥ (mm)	135	170	200	260					
Distance ⑤ (mm)	170	170	200	230	325	260			
Distance ④ (mm)	170	170	200	230	295	230	390		
Distance ③ (mm)	170	170	200	230	330	230	360	520	
Distance ② (mm)	170	170	230	230	265	295	390	520	965
Distance ① (mm)	200	200	230	295	295	490	390	550	615

Standard storage heights of the drawers

S90.196.090(WDAS)

Shelves/number	4	3
Distance ④ (mm)	320	
Distance ③ (mm)	350	420
Distance ② (mm)	350	450
Distance ① (mm)	290	380

Standard storage heights of the shelves

S90.196.090(WDAS)

Quantity	Type of container	Container size
49	Aerosol cans	400 ml
23	Cans	1 litre
23	Laboratory glass bottles	1 litre
23	Laboratory PE-bottles	1 litre
9	Laboratory glass bottles	2.5 litres

Storage capacities per drawer/type of container

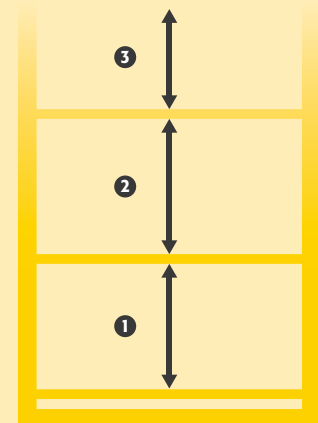

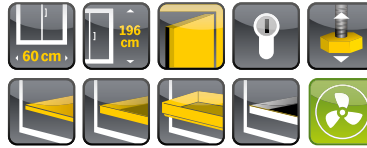

Safe and approved storage of flammable hazardous substances in working areas

Function / construction:

- **robust construction and longevity:** triple hinged door, body made of powder-coated sheet steel, safety elements assembled outside the cabinet for increased protection against corrosion
- **user-friendly and safe (model .WDAS):** door open arrest system, convenient and safe removal or storage of containers
- **no unauthorised use:** door lockable with profile cylinder (integration in an existing locking system possible)
- **easy alignment:** adjusting aids to compensate for uneven floor

- **ventilation:** integrated air ducts ready for connection (DN 75) to a technical exhaust system

Available equipment

- shelves with load capacity of 75 kg
- tray shelves with load capacity of 150 kg
- perforated insert useable as storage area
- bottom collecting sump
- drawers – high storage capacity, optimal use of the available storage capacities
- metal-free tray shelves and collecting sumps
- storage box
- sump inliner (PE or PP)

Safety storage cabinet S-CLASSIC-90 model S90.196.060

in Warning yellow (RAL 1004), interior equipment with 3 x shelf, 1 x perforated insert, 1 x bottom collecting sump (sheet steel powder-coated)

Order No. 30227-002-33659

(recirculating air filter system optional)



Metal-free interior equipment

Ideal for the storage of flammable, aggressive hazardous substances. Tray shelves with chemical resistant surface lamination and removeable plastic sump, bottom collecting plastic sump.



Drawers

High storage capacity
Ideal for the storage of small containers



Extraction unit

Safe ventilation of safety storage cabinets

plug-in – fast and easy to install

Further information and products from page 397

Order No. 14218

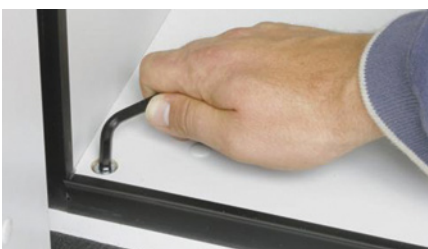

Adjusting aids

To compensate for uneven floor and an easy alignment



Shelf

Height adjustable (32 mm increments), with 30 mm upstand



Recirculating air filter system

Avoid complex wall break-throughs and expensive extraction piping

Further information from page 393

Order No. 25099



Safety storage cabinet

S-CLASSIC-90 model S90.196.060.WDAS

in Light grey (RAL 7035), interior equipment with 4 x drawer (sheet steel powder-coated)

Order No. 30228-001-33681

Safety storage cabinet

S-CLASSIC-90 model S90.196.060.WDAS

in Warning yellow (RAL 1004), interior equipment with 6 x drawer (sheet steel powder-coated)

Order No. 30228-002-33683

2 door colours are available **at no extra cost:**

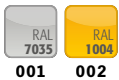

001 002

PLEASE NOTE: interior equipment with drawers can only be ordered in combination with WDAS cabinets

Order example - how to order correctly



Model	Information / equipment	Order No.
S90.196.060	without interior equipment, left hinged	30227
S90.196.060.WDAS	without interior equipment, left hinged	30228
S90.196.060.R	without interior equipment, right hinged	30229
S90.196.060.WDASR	without interior equipment, right hinged	30230

Body colour	Door colour	Order No.
Light grey RAL 7035	Light grey RAL 7035	001
Warning yellow RAL 1004	Warning yellow RAL 1004	002



















































Interior equipment packages (can only be ordered in combination with the cabinet)	Material	Order No.
3x shelf, 1x perforated insert, 1x bottom collecting sump (V=22.0L)	sheet steel powder-coated RAL 7035	old code new code
4x shelf, 1x perforated insert, 1x bottom collecting sump (V=22.0L)	sheet steel powder-coated RAL 7035	30249 33659
3x shelf, 1x bottom collecting sump (V=22.0L)	sheet steel powder-coated RAL 7035	30252 33661
4x shelf, 1x bottom collecting sump (V=22.0L)	sheet steel powder-coated RAL 7035	30253 33662
3x tray shelf (V=12.0L), 1x perforated insert, 1x bottom collecting sump (V=33.0L)	sheet steel powder-coated RAL 7035	30255 33663
3x shelf, 1x perforated insert, 1x bottom collecting sump (V=22.0L)	stainless steel	30257 30257
4x shelf, 1x perforated insert, 1x bottom collecting sump (V=22.0L)	stainless steel	30258 30258
3x shelf, 1x bottom collecting sump (V=22.0L)	stainless steel	30260 30260
4x shelf, 1x bottom collecting sump (V=22.0L)	stainless steel	30261 30261
3x tray shelf (V=12.0L), 1x perforated insert, 1x bottom collecting sump (V=33.0L)	stainless steel	30263 30263
3x tray shelf (V=11.0L), 1x bottom collecting sump (V=11.0L)	PP grey	HIGHLIGHT 30265 30265
4x tray shelf (V=11.0L), 1x bottom collecting sump (V=11.0L)	PP grey	HIGHLIGHT 30266 30266
4x drawer (V=5.0L)	sheet steel powder-coated RAL 7035	30267 33681
5x drawer (V=5.0L)	sheet steel powder-coated RAL 7035	30268 33682
6x drawer (V=5.0L)	sheet steel powder-coated RAL 7035	30269 33683
3x drawer (V=5.0L), 1x drawer (disposal) (V=30.0L)	sheet steel powder-coated RAL 7035	30270 33684
4x drawer (V=5.0L), 1x drawer (disposal) (V=30.0L)	sheet steel powder-coated RAL 7035	30271 33685
4x drawer (V=5.0L)	stainless steel	30272 33686
5x drawer (V=5.0L)	stainless steel	30273 33687
6x drawer (V=5.0L)	stainless steel	30274 33688
3x drawer (V=5.0L), 1x drawer (disposal) (V=30.0L)	stainless steel	30275 33689
4x drawer (V=5.0L), 1x drawer (disposal) (V=30.0L)	stainless steel	30276 33690



Individual configuration of model S90.196.060 / S90.196.060.WDAS

 Model	Information / equipment	W x D x H (mm)	Order No.
S90.196.060	without interior equipment, left hinged	596 x 616 x 1968	30227
S90.196.060.WDAS	without interior equipment, left hinged	596 x 616 x 1968	30228
S90.196.060.R	without interior equipment, right hinged	596 x 616 x 1968	30229
S90.196.060.WDASR	without interior equipment, right hinged	596 x 616 x 1968	30230

 Body colour	Door colour	Order No.
Light grey RAL 7035	Light grey RAL 7035	001 
Warning yellow RAL 1004	Warning yellow RAL 1004	002 

 Interior equipment	Material	W x D x H (mm)	 ¹⁾	 ²⁾	 ³⁾	Order No.	
						old code	new code
 shelf	sheet steel powder-coated RAL 7035	440 x 432 x 30*	75.00			30098	30098 
	stainless steel	440 x 432 x 30*	75.00			30102	30102 
 tray shelf	sheet steel powder-coated RAL 7035	427 x 442 x 70*	150.00	12.00	10.91	30099	30099 
	stainless steel	427 x 442 x 70*	150.00	12.00	10.91	30103	30103 
 tray shelf, metal-free	PP grey	424 x 472 x 67*	50.00	13.00	11.82	30106	30106 
 perforated insert	sheet steel powder-coated RAL 7035	420 x 439 x 60	75.00			5555	5555 
	stainless steel	425 x 439 x 60	75.00			5776	5776 
 bottom collecting sump	sheet steel powder-coated RAL 7035	442 x 507 x 127		22.00	20.00	30100	33594 
	stainless steel	418 x 433 x 120*		22.00	20.00	30104	30104 
 bottom collecting sump, height = 180 mm	sheet steel powder-coated RAL 7035	409 x 474 x 171*		33.00	30.00	30101	33605 
 bottom collecting sump, height = 170 mm	stainless steel	439 x 454 x 170*		33.00	30.00	30105	30105 
 bottom collecting sump, metal-free	PP grey	422 x 472 x 67*		12.50	11.36	25424	25424 
 drawer	sheet steel powder-coated RAL 7035	345 x 500 x 50*	25.00	5.00	4.55	30108	33607 
	stainless steel	345 x 500 x 50*	25.00	5.00	4.55	30110	33614 
 drawer (disposal)	sheet steel powder-coated RAL 7035	329 x 462 x 200*	50.00	30.00		30109	30109 
	stainless steel	329 x 462 x 150*	50.00	30.00		30111	30111 
 storage box, left hinged	sheet steel powder-coated RAL 7035	380 x 420 x 360				30029	30029 
 storage box, right hinged	sheet steel powder-coated RAL 7035	380 x 420 x 360				30030	30030 
 sump inliner, for drawer disposal	PP grey	318 x 449 x 66*				18472	18472 
 sump inliner	PP grey	353 x 406 x 88*				9706	9706 
 sump inliner, for drawer disposal	PP black	313 x 413 x 171*				18474	18474 
 anti-slip rubber mat, for drawer disposal	black	495 x 340 x 1				8719	8719 
 pipe lead-through	sheet steel powder-coated RAL 7035	182 x 104 x 48				30035	30035 
 box for chemicals	PP blue	410 x 300 x 260		18.00	16.36	30038	30038 
 transport base, height = 118 mm	steel powder-coated RAL 7035	595 x 610 x 118				30725	30725 
 document holder, DIN A5	polystyrene					30793	30793 

 Accessories	Order No.
recirculating air filter system with exhaust air monitoring	25099 
extraction unit without exhaust air monitoring	14218 

* usable storage space W x D (mm)

1) load capacity (kg), 2) retention capacity (ltr), 3) maximum container volume in the cabinet (ltr)

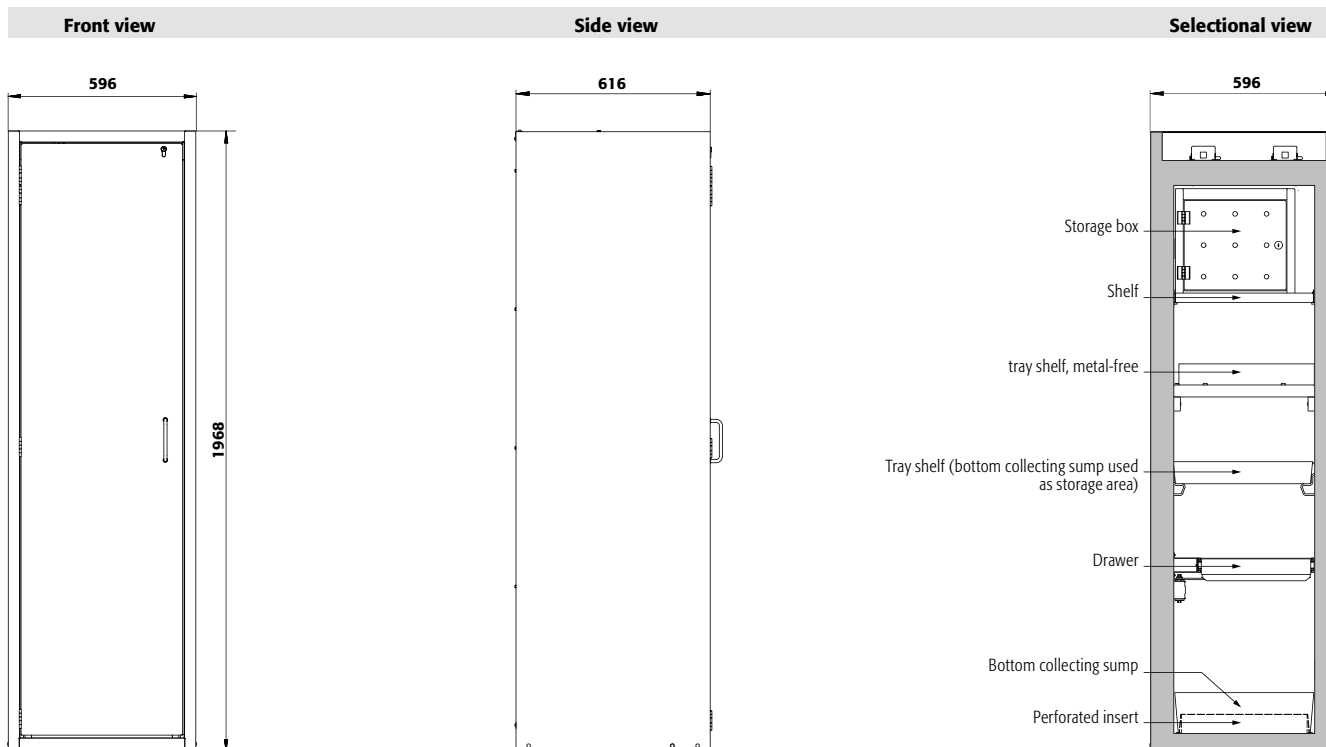

Technical data		S90.196.060(WDAS)	
External dimensions W x D x H	mm	596 x 616 x 1968	
Internal dimensions W x D x H	mm	450 x 524 x 1742	
Weight without interior equip.	kg	260	
Air change 10 times	m ³ /h	4	
Diff. pressure (air change 10 times EK5/AK4)	Pa	5	
Diff. pressure (air change 10 times)	Pa	5	
Maximum load	kg	600	
Distributed load	kg/m ²	893	
Transport base optional			
Entry height	mm	95	
Entry width	mm	2 x 224	

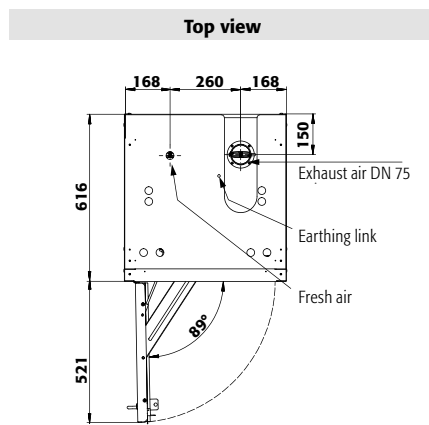

S90.196.060(WDAS)		Standard storage heights of the drawers										
Drawers/number		9	8	7	6	5	4+1	4	3+1	3	2	
Distance ⑨ (mm)	175											
Distance ⑧ (mm)	135	175										
Distance ⑦ (mm)	135	170	175									
Distance ⑥ (mm)	135	170	200	270								
Distance ⑤ (mm)	170	170	200	230	335	275						
Distance ④ (mm)	170	170	200	230	295	200	365	305				
Distance ③ (mm)	170	200	230	230	295	230	390	330	525			
Distance ② (mm)	170	200	230	230	295	230	390	330	520	975		
Distance ① (mm)	170	200	230	295	295	475	390	475	520	615		
S90.196.060(WDAS)		Standard storage heights of the shelves										
Shelves/number						4			3			
Distance ④ (mm)	320											
Distance ③ (mm)	350											
Distance ② (mm)	350											
Distance ① (mm)	290											
S90.196.060(WDAS)		Storage capacities per drawer/type of container										
Quantity	Type of container	Container size										
30	Aerosol cans	400 ml										
12	Cans	1 litre										
12	Laboratory glass bottles	1 litre										
12	Laboratory PE-bottles	1 litre										
6	Laboratory glass bottles	2.5 litres										

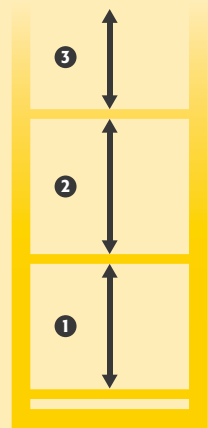

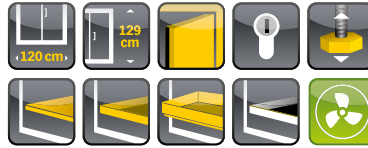

Safe and approved storage of flammable hazardous substances in working areas

Function / construction:

- **robust construction and longevity:** triple hinged door, body made of powder-coated sheet steel, safety elements assembled outside the cabinet for increased protection against corrosion
- **user-friendly and safe (model .WDAS):** door open arrest system, convenient and safe removal or storage of containers
- **no unauthorised use:** doors lockable with profile cylinder (integration in an existing locking system possible)
- **easy alignment:** adjusting aids to compensate for uneven floor

- **ventilation:** integrated air ducts ready for connection (DN 75) to a technical exhaust system

Available equipment

- shelves with load capacity of 75 kg
- tray shelves with load capacity of 150 kg
- perforated insert useable as storage area
- bottom collecting sump
- drawers – high storage capacity, optimal use of the available storage capacities
- drawers heavy-duty with load capacity of 100 kg
- metal-free tray shelves and collecting sumps
- storage box
- sump inliner (PE or PP)

Safety storage cabinet

S-CLASSIC-90 model S90.129.120

in Warning yellow (RAL 1004), interior equipment with 2 x shelf, 1 x perforated insert, 1 x bottom collecting sump (sheet steel powder-coated)

Order No. 30121-002-33744

(recirculating air filter system optional)



Drawers

High storage capacity
Ideal for the storage of small containers



Shelf

Height adjustable (32 mm increments), with 30 mm upstand

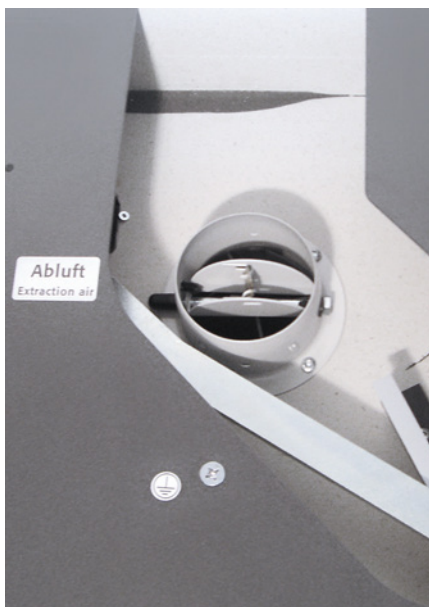

Quickly put into operation

Integrated air ducts ready for connection (DN 75) to a technical exhaust system



Extraction unit

Safe ventilation of safety storage cabinets

plug-in – fast and easy to install

Further information and products from page 397

Order No. 14218



Recirculating air filter system

Avoid complex wall breakthroughs and expensive extraction piping

Further information from page 393

Order No. 25099



Safety storage cabinet
S-CLASSIC-90 model S90.129.120.WDAS
 in Warning yellow (RAL 1004), interior equipment with 2 x drawer (sheet steel powder-coated)
Order No. 30122-002-33753

Safety storage cabinet
S-CLASSIC-90 model S90.129.120.WDAS
 in Light grey (RAL 7035), interior equipment with 3 x drawer (sheet steel powder-coated)
Order No. 30122-001-33754

2 door colours are available **at no extra cost:**

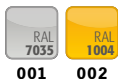

001 002

PLEASE NOTE: interior equipment with drawers can only be ordered in combination with WDAS cabinets

Order example - how to order correctly



30122 - 001 - 33754

Model	Information / equipment	Order No.
S90.129.120.WDAS	without interior equipment	30122
S90.129.120	without interior equipment	30121

Body colour	Door colour	Order No.
Light grey RAL 7035	Light grey RAL 7035	001
Warning yellow RAL 1004	Warning yellow RAL 1004	002























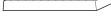











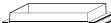

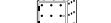





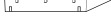



Interior equipment packages (can only be ordered in combination with the cabinet)	Material	Order No.
2x shelf, 1x perforated insert, 1x bottom collecting sump (V=33.0L)	sheet steel powder-coated RAL 7035	30155 33744
3x shelf, 1x perforated insert, 1x bottom collecting sump (V=33.0L)	sheet steel powder-coated RAL 7035	30156 33745
2x shelf, 1x bottom collecting sump (V=33.0L)	sheet steel powder-coated RAL 7035	30157 33746
3x shelf, 1x bottom collecting sump (V=33.0L)	sheet steel powder-coated RAL 7035	30158 33747
2x tray shelf (V=33.0L), 1x perforated insert, 1x bottom collecting sump (V=55.5L)	sheet steel powder-coated RAL 7035	30159 33748
2x shelf, 1x perforated insert, 1x bottom collecting sump (V=33.0L)	stainless steel	30160 33749
3x shelf, 1x perforated insert, 1x bottom collecting sump (V=33.0L)	stainless steel	30161 33750
2x shelf, 1x bottom collecting sump (V=33.0L)	stainless steel	30162 33751
3x shelf, 1x bottom collecting sump (V=33.0L)	stainless steel	30163 33752
2x tray shelf (V=33.0L), 1x bottom collecting sump (V=33.0L)	PP grey	HIGHLIGHT 30165 30165
3x tray shelf (V=33.0L), 1x bottom collecting sump (V=33.0L)	PP grey	HIGHLIGHT 30166 30166
2x drawer (V=30.0L)	sheet steel powder-coated RAL 7035	30167 33753
3x drawer (V=30.0L)	sheet steel powder-coated RAL 7035	30168 33754
2x drawer (V=30.0L)	stainless steel	30169 33755
3x drawer (V=30.0L)	stainless steel	30170 33756



Individual configuration of model S90.129.120 / S90.129.120.WDAS

 Model	Information / equipment	W x D x H (mm)	Order No.
S90.129.120	without interior equipment	1196 x 616 x 1298	30121
S90.129.120.WDAS	without interior equipment	1196 x 616 x 1298	30122

 Body colour	Door colour	Order No.
Light grey RAL 7035	Light grey RAL 7035	001 
Warning yellow RAL 1004	Warning yellow RAL 1004	002 

 Interior equipment	Material	W x D x H (mm)	 1)	 2)	 3)	Order No.	
						old code	new code
 shelf	sheet steel powder-coated RAL 7035	1040 x 432 x 30*	75.00			30021	30021 
	stainless steel	1038 x 425 x 29*	75.00			30024	30024 
 tray shelf	sheet steel powder-coated RAL 7035	1025 x 445 x 71*	150.00	33.00	30.00	30028	30028 
	stainless steel	1025 x 445 x 71*	150.00	33.00	30.00	30064	30064 
 tray shelf, metal-free	PP grey	1002 x 472 x 74*	50.00	33.00	30.00	30027	30027 
 perforated insert	sheet steel powder-coated RAL 7035	1024 x 417 x 60	75.00			5536	5536 
	stainless steel	1024 x 417 x 60	75.00			5773	5773 
 perforated insert, height = 135 mm	sheet steel powder-coated RAL 7035	1024 x 417 x 135	135.00			14084	14084 
 bottom collecting sump	sheet steel powder-coated RAL 7035	1024 x 489 x 86*		33.00	30.00	30022	33634 
	stainless steel	1024 x 489 x 86*	150.00	33.00	30.00	30025	33641 
 bottom collecting sump, V = 55,5 ltr.	sheet steel powder-coated RAL 7035	1017 x 482 x 127*		55.50	50.45	30023	33639 
	stainless steel	1018 x 438 x 120*		55.50	50.00	30026	30026 
 bottom collecting sump, metal-free	PP grey	1002 x 472 x 74*		33.00	30.00	26989	26989 
 drawer	sheet steel powder-coated RAL 7035	844 x 488 x 90*	60.00	30.00	2727	30013	33646 
	stainless steel	844 x 488 x 90*	60.00	30.00	2727	30033	33650 
 drawer (heavy-duty)	sheet steel powder-coated RAL 7035	843 x 487 x 162*	100.00	66.00		30032	30032 
	stainless steel	843 x 487 x 162*	100.00	66.00		30034	30034 
 storage box, left hinged	sheet steel powder-coated RAL 7035	380 x 420 x 360				30029	30029 
 storage box, right hinged	sheet steel powder-coated RAL 7035	380 x 420 x 360				30030	30030 
 sump inliner, for shelf	polyethylene black	1000 x 392 x 50*				7223	7223 
 sump inliner, for drawer	PP grey	834 x 450 x 96*				10054	10054 
 anti-slip rubber mat, for drawer	black	840 x 490 x 1				8699	8699 
 pipe lead-through	sheet steel powder-coated RAL 7035	182 x 104 x 48				30035	30035 
 box for chemicals	PP blue	410 x 300 x 260		18.00	16.36	30038	30038 
 transport base, height = 118 mm	steel powder-coated RAL 7035	1195 x 610 x 118				30171	30171 
 document holder, DIN A5	polystyrene					30793	30793 

 Accessories	Order No.
recirculating air filter system with exhaust air monitoring	25099 
extraction unit without exhaust air monitoring	14218 

* usable storage space W x D [mm]

1) load capacity [kg], 2) retention capacity [ltr], 3) maximum container volume in the cabinet [ltr]

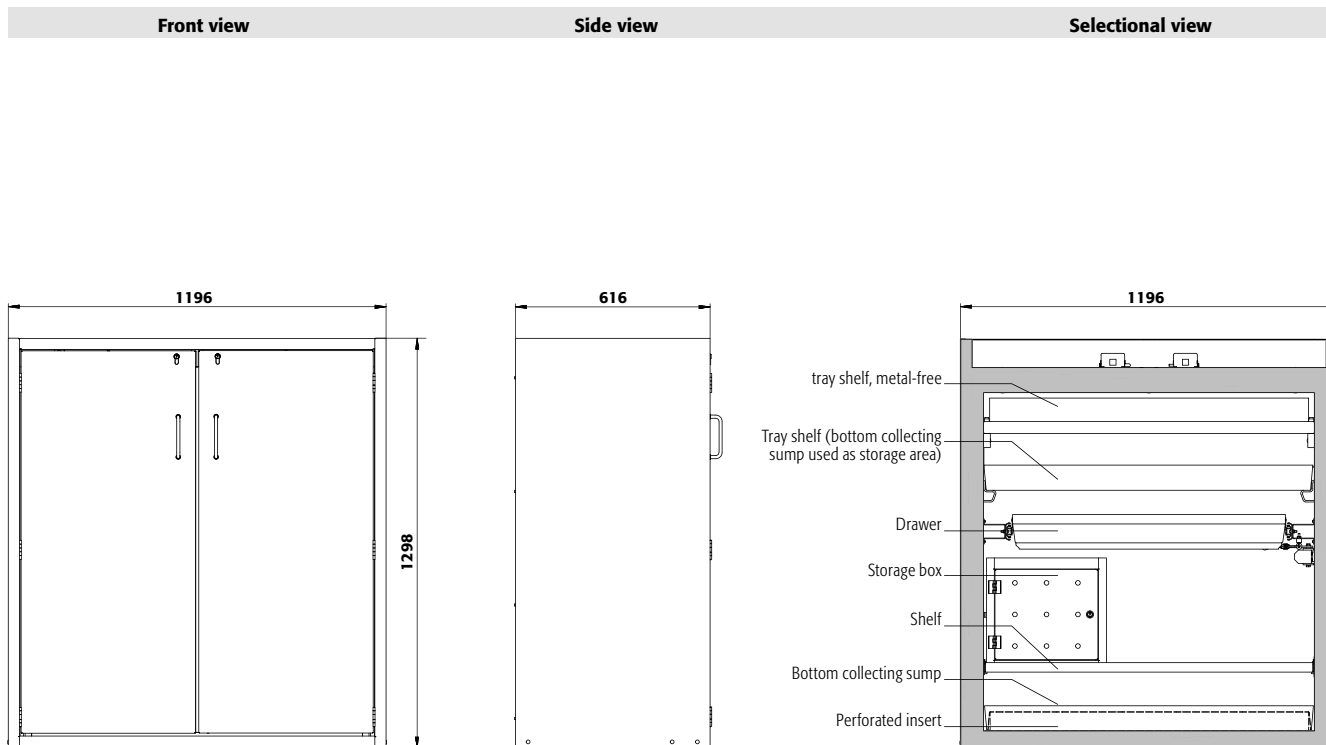

Technical data		S90.129.120(WDAS)	
External dimensions W x D x H	mm	1196 x 616 x 1298	
Internal dimensions W x D x H	mm	1050 x 524 x 1072	
Weight without interior equip.	kg	270	
Air change 10 times	m ³ /h	6	
Diff. pressure (air change 10 times EK5/AK4)	Pa	5	
Diff. pressure (air change 10 times)	Pa	5	
Maximum load	kg	600	
Distributed load	kg/m ²	450	
Transport base optional			
Entry height	mm	100	
Entry width	mm	2 x 440	

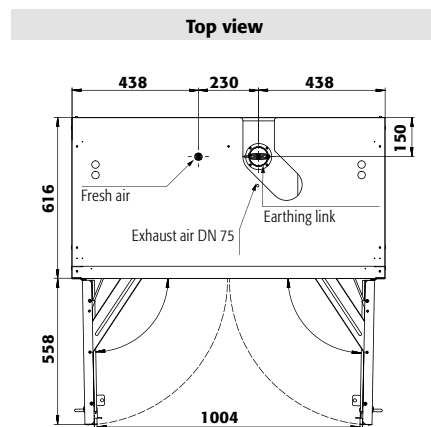

S90.129.120(WDAS)		Standard storage heights of the drawers	
Drawers/number		3	2
Distance 3 (mm)		310	
Distance 2 (mm)		295	435
Distance 1 (mm)		295	485
S90.129.120(WDAS)			
Standard storage heights of the shelves		3	2
Shelves/number			
Distance 3 (mm)		260	
Distance 2 (mm)		290	350
Distance 1 (mm)		190	290
S90.196.120(WDAS)			
Storage capacities per drawer/type of container			
Quantity	Type of container	Container size	
90	Aerosol cans	400 ml	
40	Cans	1 litre	
40	Laboratory glass bottles	1 litre	
40	Laboratory PE-bottles	1 litre	
15	Laboratory glass bottles	2.5 litres	

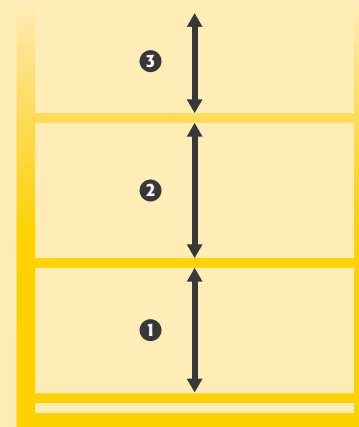

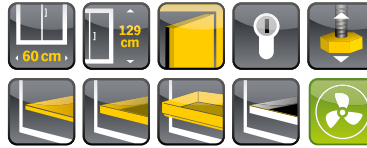

Safe and approved storage of flammable hazardous substances in working areas

Function / construction:

- **robust construction and longevity:** triple hinged door, body made of powder-coated sheet steel, safety elements assembled outside the cabinet for increased protection against corrosion
- **user-friendly and safe (model .WDAS):** door open arrest system, convenient and safe removal or storage of containers
- **no unauthorised use:** door lockable with profile cylinder (integration in an existing locking system possible)
- **easy alignment:** adjusting aids to compensate for uneven floor

- **ventilation:** integrated air ducts ready for connection (DN 75) to a technical exhaust system

Available equipment

- shelves with load capacity of 75 kg
- tray shelves with load capacity of 150 kg
- perforated insert useable as storage area
- bottom collecting sump
- drawers – high storage capacity, optimal use of the available storage capacities
- metal-free tray shelves and collecting sumps
- storage box
- sump inliner (PE or PP)

Safety storage cabinet S-CLASSIC-90 model S90.129.060

in Warning yellow (RAL 1004), interior equipment with 2 x shelf, 1 x perforated insert, 1 x bottom collecting sump (sheet steel powder-coated)

Order No. 30238-002-33735

(recirculating air filter system optional)



Drawers

High storage capacity
Ideal for the storage of small containers



Bottom collecting sump

High storage capacity, optimal for the storage of larger containers, safe collection of leakages



Extraction unit

Safe ventilation of safety storage cabinets

plug-in – fast and easy to install

Further information and products from page 397

Order No. 14218



Shelf

Height adjustable (32 mm increments), with 30 mm upstand

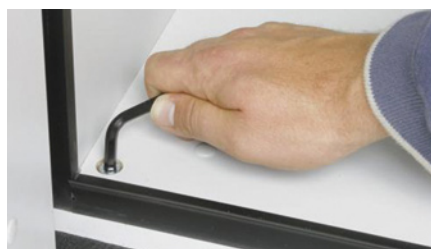

Adjusting aids

To compensate for uneven floor and an easy alignment

Recirculating air filter system

Avoid complex wall break-throughs and expensive extraction piping

Further information from page 393

Order No. 25099





Safety storage cabinet

S-CLASSIC-90 model S90.129.060.WDAS

in Light grey (RAL 7035), interior equipment with 2 x drawer (sheet steel powder-coated)

Order No. 30239-001-33740

Safety storage cabinet

S-CLASSIC-90 model S90.129.060.WDAS

in Warning yellow (RAL 1004), interior equipment with 3 x drawer (sheet steel powder-coated)

Order No. 30239-002-33741

2 door colours are available **at no extra cost:**

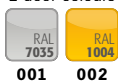

PLEASE NOTE: interior equipment with drawers can only be ordered in combination with WDAS cabinets

Order example - how to order correctly



Model	Information / equipment	Order No.
S90.129.060	without interior equipment, left hinged	30238
S90.129.060.R	without interior equipment, right hinged	30240
S90.129.060.WDAS	without interior equipment, left hinged	30239
S90.129.060.WDASR	without interior equipment, right hinged	30241

Body colour	Door colour	Order No.
Light grey RAL 7035	Light grey RAL 7035	001
Warning yellow RAL 1004	Warning yellow RAL 1004	002



















































Interior equipment packages (can only be ordered in combination with the cabinet)	Material	Order No.
		old code new code
2x shelf, 1x perforated insert, 1x bottom collecting sump (V=22.0L)	sheet steel powder-coated RAL 7035	30277 33735
3x shelf, 1x perforated insert, 1x bottom collecting sump (V=22.0L)	sheet steel powder-coated RAL 7035	30278 33736
2x shelf, 1x bottom collecting sump (V=22.0L)	sheet steel powder-coated RAL 7035	30279 33737
3x shelf, 1x bottom collecting sump (V=22.0L)	sheet steel powder-coated RAL 7035	30280 33738
2x tray shelf (V=12.0L), 1x perforated insert, 1x bottom collecting sump (V=33.0L)	sheet steel powder-coated RAL 7035	30281 33739
2x shelf, 1x perforated insert, 1x bottom collecting sump (V=22.0L)	stainless steel	30283 30283
3x shelf, 1x perforated insert, 1x bottom collecting sump (V=22.0L)	stainless steel	30284 30284
2x shelf, 1x bottom collecting sump (V=22.0L)	stainless steel	30285 30285
3x shelf, 1x bottom collecting sump (V=22.0L)	stainless steel	30286 30286
2x tray shelf (V=12.0L), 1x perforated insert, 1x bottom collecting sump (V=33.0L)	stainless steel	30287 30287
2x tray shelf (V=11.0L), 1x bottom collecting sump (V=11.0L)	PP grey	HIGHLIGHT 30289 30289
3x tray shelf (V=11.0L), 1x bottom collecting sump (V=11.0L)	PP grey	HIGHLIGHT 30290 30290
2x drawer (V=5.0L)	sheet steel powder-coated RAL 7035	30721 33740
3x drawer (V=5.0L)	sheet steel powder-coated RAL 7035	30722 33741
2x drawer (V=5.0L)	stainless steel	30723 33742
3x drawer (V=5.0L)	stainless steel	30724 33743



Individual configuration of model S90.129.060 / S90.129.060.WDAS

 Model	Information / equipment	W x D x H (mm)	Order No.
S90.129.060	without interior equipment, left hinged	596 x 616 x 1298	30238
S90.129.060.R	without interior equipment, right hinged	596 x 616 x 1298	30240
S90.129.060.WDAS	without interior equipment, left hinged	596 x 616 x 1298	30239
S90.129.060.WDASR	without interior equipment, right hinged	596 x 616 x 1298	30241

 Body colour	Door colour	Order No.
Light grey RAL 7035	Light grey RAL 7035	001 
Warning yellow RAL 1004	Warning yellow RAL 1004	002 

 Interior equipment	Material	W x D x H (mm)	 1)	 2)	 3)	Order No.
						old code new code
 shelf	sheet steel powder-coated RAL 7035	440 x 432 x 30*	75.00			30098 30098 
	stainless steel	440 x 432 x 30*	75.00			30102 30102 
 tray shelf	sheet steel powder-coated RAL 7035	427 x 442 x 70*	150.00	12.00	10.91	30099 30099 
	stainless steel	427 x 442 x 70*	150.00	12.00	10.91	30103 30103 
 tray shelf, metal-free	PP grey	424 x 472 x 67*	50.00	13.00	11.82	30106 30106 
 perforated insert	sheet steel powder-coated RAL 7035	420 x 439 x 60	75.00			5555 5555 
	stainless steel	425 x 439 x 60	75.00			5776 5776 
 bottom collecting sump	sheet steel powder-coated RAL 7035	442 x 507 x 127		22.00	20.00	30100 33594 
	stainless steel	418 x 433 x 120*		22.00	20.00	30104 30104 
 bottom collecting sump, height = 180 mm	sheet steel powder-coated RAL 7035	409 x 474 x 171*		33.00	30.00	30101 33605 
 bottom collecting sump, height = 170 mm	stainless steel	439 x 454 x 170*		33.00	30.00	30105 30105 
 bottom collecting sump, metal-free	PP grey	422 x 472 x 67*		12.50	11.36	25424 25424 
 drawer	sheet steel powder-coated RAL 7035	345 x 500 x 50*	25.00	5.00	4.55	30108 33607 
	stainless steel	345 x 500 x 50*	25.00	5.00	4.55	30110 33614 
 drawer (disposal)	sheet steel powder-coated RAL 7035	329 x 462 x 200*	50.00	30.00		30109 30109 
	stainless steel	329 x 462 x 150*	50.00	30.00		30111 30111 
 storage box, left hinged	sheet steel powder-coated RAL 7035	380 x 420 x 360				30029 30029 
 storage box, right hinged	sheet steel powder-coated RAL 7035	380 x 420 x 360				30030 30030 
 sump inliner, for drawer disposal	PP grey	318 x 449 x 66*				18472 18472 
 sump inliner	PP grey	353 x 406 x 88*				9706 9706 
 sump inliner, for drawer disposal	PP black	313 x 413 x 171*				18474 18474 
 anti-slip rubber mat, for drawer disposal	black	495 x 340 x 1				8719 8719 
 pipe lead-through	sheet steel powder-coated RAL 7035	182 x 104 x 48				30035 30035 
 box for chemicals	PP blue	410 x 300 x 260		18.00	16.36	30038 30038 
 transport base, height = 118 mm	steel powder-coated RAL 7035	595 x 610 x 118				30725 30725 
 document holder, DIN A5	polystyrene					30793 30793 

 Accessories	Order No.
recirculating air filter system with exhaust air monitoring	25099 
extraction unit without exhaust air monitoring	14218 

* usable storage space W x D (mm)
 1) load capacity (kg), 2) retention capacity (ltr), 3) maximum container volume in the cabinet (ltr)

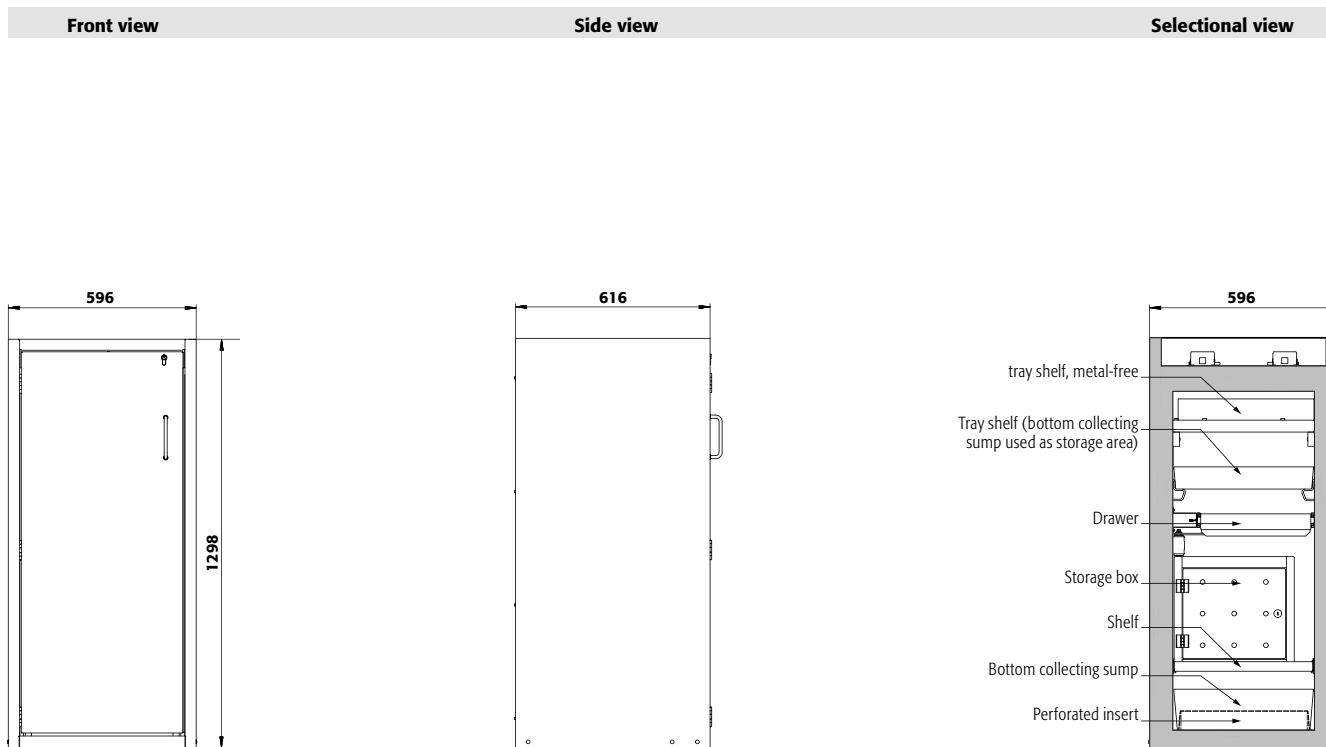

Technical data		S90.129.060(WDAS)	
External dimensions W x D x H	mm	596 x 616 x 1298	
Internal dimensions W x D x H	mm	450 x 524 x 1072	
Weight without interior equip.	kg	170	
Air change 10 times	m ³ /h	3	
Diff. pressure (air change 10 times EK5/AK4)	Pa	5	
Diff. pressure (air change 10 times)	Pa	5	
Maximum load	kg	600	
Distributed load	kg/m ²	799	
Transport base optional			
Entry height	mm	95	
Entry width	mm	2 x 224	

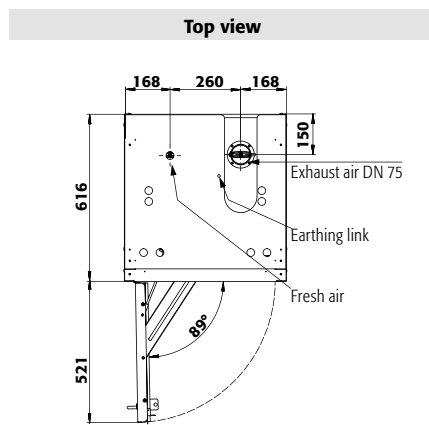

S90.129.060(WDAS)		Standard storage heights of the drawers	
Drawers/number	3	2	
Distance 3 (mm)	305		
Distance 2 (mm)	295	430	
Distance 1 (mm)	295	490	
S90.129.060(WDAS)			
Standard storage heights of the shelves			
Shelves/number	3	2	
Distance 3 (mm)	260		
Distance 2 (mm)	290	350	
Distance 1 (mm)	190	290	
S90.129.060(WDAS)			
Storage capacities per drawer/type of container			
Quantity	Type of container	Container size	
30	Aerosol cans	400 ml	
12	Cans	1 litre	
12	Laboratory glass bottles	1 litre	
12	Laboratory PE-bottles	1 litre	
6	Laboratory glass bottles	2.5 litres	

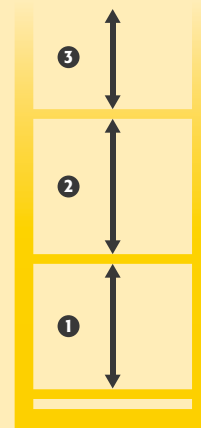



Wolflabs

Wolf Laboratories Limited

www.wolflabs.co.uk

Tel: 01759 301142

Fax: 01759 301143

sales@wolflabs.co.uk



Use the above details to contact us if this literature doesn't answer all your questions.

Pricing on any accessories shown can be found by keying the part number into the search box on our website.

The specifications listed in this brochure are subject to change by the manufacturer and therefore cannot be guaranteed to be correct. If there are aspects of the specification that must be guaranteed, please provide these to our sales team so that details can be confirmed.

