

Xograph Imaging Systems Ltd  
Xograph House, Hampton Street,  
Tetbury, Glos., GL8 8LD, UK

Tel: +44 (0)1666 501 501  
Fax: +44 (0)1666 501 501



[enquiry@xograph.com](mailto:enquiry@xograph.com) [www.xograph.com](http://www.xograph.com)

# Fullite Illuminators

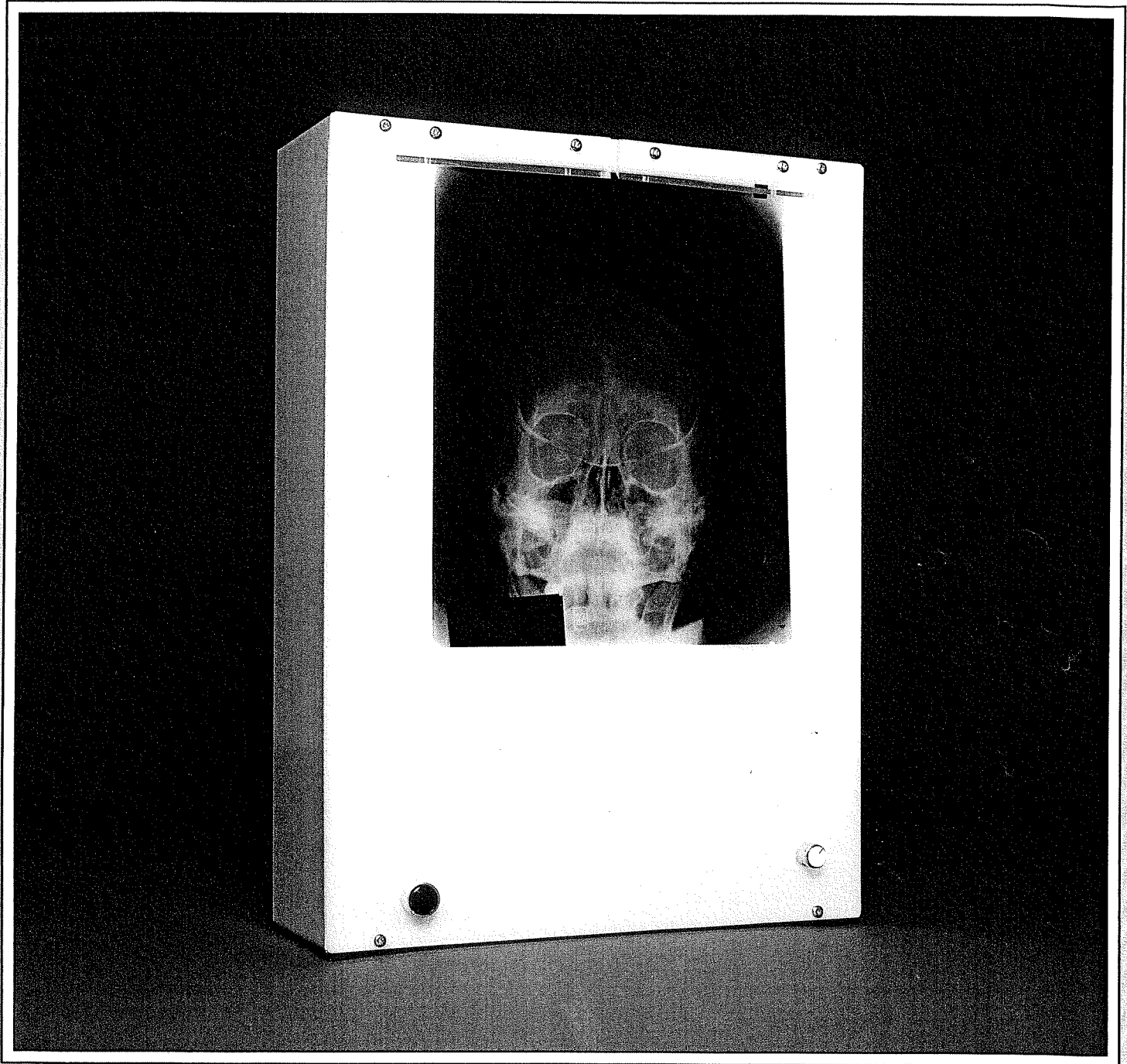

A range of 'Fullite' X-ray film viewers offer edge to edge opal 'Perspex' viewing panel with clear plastic film retainer. Bodies are constructed in 20 gauge rust resistant steel, finished outside in hard stove enamel, the interior high reflective white; rubber feet are fitted for desk top protection and two 9.5mm holes are provided in the back of the case for wall fixing.

Available in 1, 2, 3 and 4 panel models, suitable for free-standing desk top use, on a mobile stand, surface wall fixing or inset wall fixing. The standard model is fitted with an on/off rotary switch; the dimmer model a combined on/off thyristor dimmer switch. A quartz halogen spotlight may be fitted to the centre of the right hand panel as an optional extra.

# Fullite Illuminators

## MECHANICAL SPECIFICATIONS

1 way illuminator

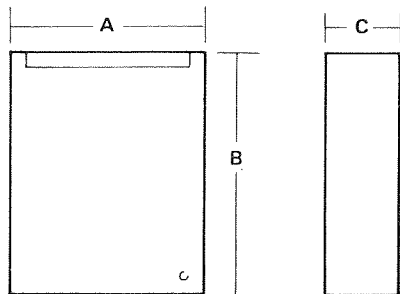

2 way illuminator

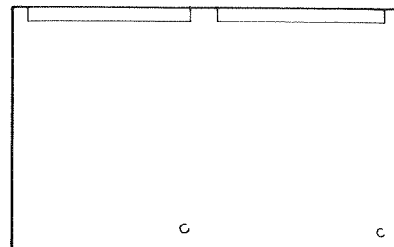

Wall mounting details

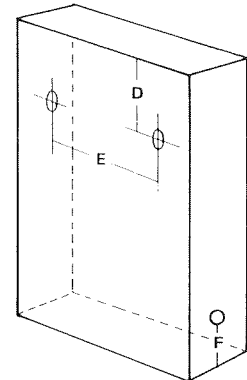

3 way illuminator

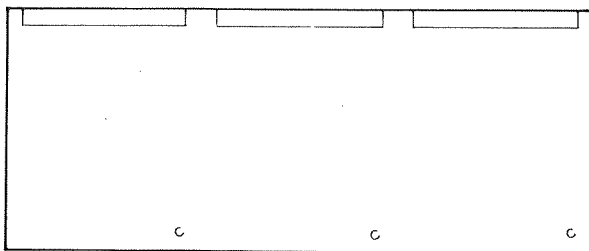

4 way illuminator

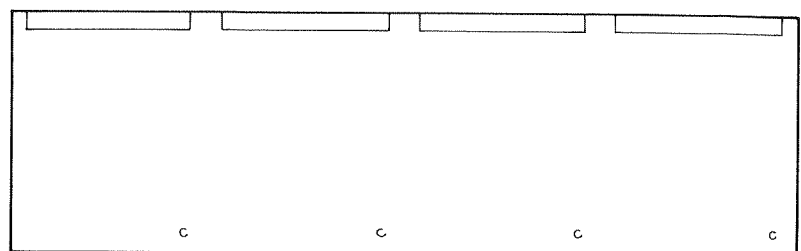

DIMENSION	1 way illuminator	2 way illuminator	3 way illuminator	4 way illuminator
A	14 <sup>1</sup> / <sub>4</sub> " / 362mm	28 <sup>1</sup> / <sub>2</sub> " / 724mm	42 <sup>3</sup> / <sub>4</sub> " / 1086mm	57" / 1448mm
B	19 <sup>5</sup> / <sub>8</sub> " / 500mm	19 <sup>5</sup> / <sub>8</sub> " / 500mm	19 <sup>5</sup> / <sub>8</sub> " / 500mm	19 <sup>5</sup> / <sub>8</sub> " / 500mm
C	4 <sup>3</sup> / <sub>4</sub> " / 120mm	4 <sup>3</sup> / <sub>4</sub> " / 120mm	4 <sup>3</sup> / <sub>4</sub> " / 120mm	4 <sup>3</sup> / <sub>4</sub> " / 120mm
D	2 <sup>3</sup> / <sub>4</sub> " / 70mm	2 <sup>3</sup> / <sub>4</sub> " / 70mm	2 <sup>3</sup> / <sub>4</sub> " / 70mm	2 <sup>3</sup> / <sub>4</sub> " / 70mm
E	11 <sup>1</sup> / <sub>4</sub> " / 286mm	25 <sup>1</sup> / <sub>2</sub> " / 648mm	39 <sup>3</sup> / <sub>4</sub> " / 1010mm	54" / 1372mm
F	2 <sup>1</sup> / <sub>2</sub> " / 64mm	2 <sup>1</sup> / <sub>2</sub> " / 64mm	2 <sup>1</sup> / <sub>2</sub> " / 64mm	2 <sup>1</sup> / <sub>2</sub> " / 64mm
Nett Weights	13 <sup>3</sup> / <sub>4</sub> lb / 6.01kg	24 <sup>1</sup> / <sub>2</sub> lb / 11.11kg	35 <sup>3</sup> / <sub>4</sub> lb / 16.22kg	49lb / 22.22kg

Detail of inset wall illuminator

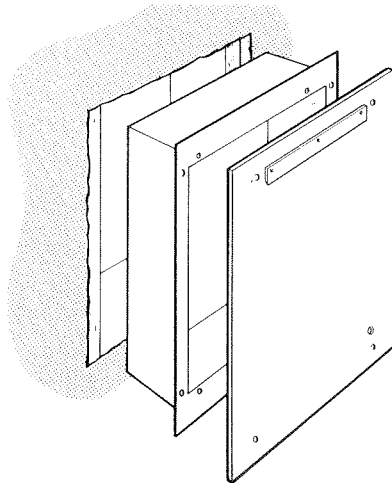

Mounting types

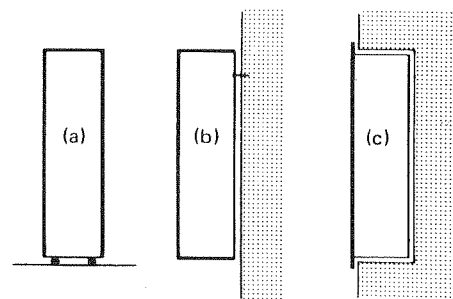

A = Bench top use B = Surface wall fixing  
C = Inset wall fixing

## ELECTRICAL SPECIFICATION

The illuminators are fitted with two 15 watt, 18" long fluorescent tubes per panel with components conforming to the appropriate British Standards: wiring is to the safety standards specified in BS:5724. Electrical rating 230/240 volts 50 Hz AC (other voltages and frequencies to special order). Each illuminator is fitted with 2 metres of 3 core cable.

Xograph Imaging Systems Ltd  
Xograph House, Hampton Street,  
Tetbury, Glos., GL8 8LD, UK

Tel: +44 (0)1666 501 501  
Fax: +44 (0)1666 501 501



Xograph Imaging Systems Ltd  
Xograph House, Hampton Street,  
Tetbury, Glos., GL8 8LD, UK

Tel: +44 (0)1666 501 501  
Fax: +44 (0)1666 501 501

