



UV mini-1240

Shimadzu Spectrophotometer

The UV Mini Spectrophotometer with Major Features

**MEGA performance in a Mini space
(paper size foot print and light weight)
MEGA capabilities at a Mini price**

UV mini-1240



Minimal Training — Easy to Use

The large liquid-crystal display (LCD) has been incorporated with easy to follow prompts, large fonts, and graphics to help reduce the time needed to get your results. The description on the instrument's soft keypad quickly guides you through specific programs.

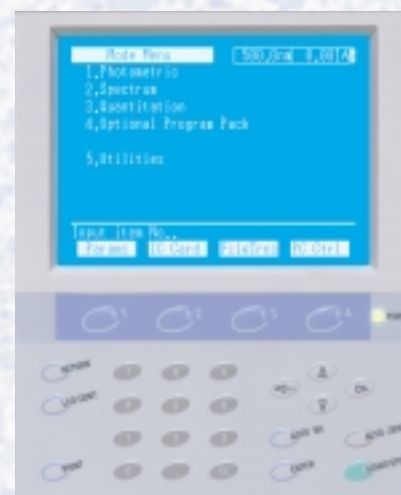

Mighty Performance with Quantitative Methods

Everything from simple concentration measurements up to sophisticated quantitative calibration curves. Some of the standard functions include:

- Factor method for input of simple constants.
- One point calibration curve with one standard sample and a point through the origin.
- Multi-point calibration curve of the application requiring various standards. 1st, 2nd, and 3rd order polynomial fitting for calibration come standard.
- Two or Three wavelength quantitative analysis for measuring turbid samples or for measuring the effects of another distinguishable component.

Maximum Wavelength Scanning

The UV Mini comes standard with a Spectrum mode that allows for full spectral data acquisition over the wavelength range of 190nm to 1100nm. Upon completion of the spectral scan, the peaks and valleys can be marked within a few seconds. The standard peak pick function allows for clear and accurate detection of the most sensitive wavelengths.

Mega Data Archiving Capabilities

Methods, results, and raw data can be saved on either the standalone instrument, optional dedicated IC Data cards, or within a directory of an IBM Compatible PC with the help of the optional NEW UV DATA MANAGER software. This provides unlimited storage and expanded capabilities in archiving methods and management of essential results.

Multiple Print Utilities

The UV Mini provides flexible print options with the use of either a thermal screen copy printer or a variety of different PC printers. The screen copy printer enables instant printing of tabulated data as well as copied information directly from the screen. The PC printers can be utilized for the same functions and for finer print resolution of spectral data.

Mini Effort to Customize

With over 35 different types of attachments including multicell positioners, sippers, temperature control devices, the UV Mini can provide all the tools necessary to fit your specific application. The IC program cards quickly expand the functionality of the instrument. By simply inserting the appropriate IC card into the slot on the front panel, dedicated applications such as DNA/Protein analysis can now be performed.

Standard Applications with Each UV Mini Spectrophotometer!

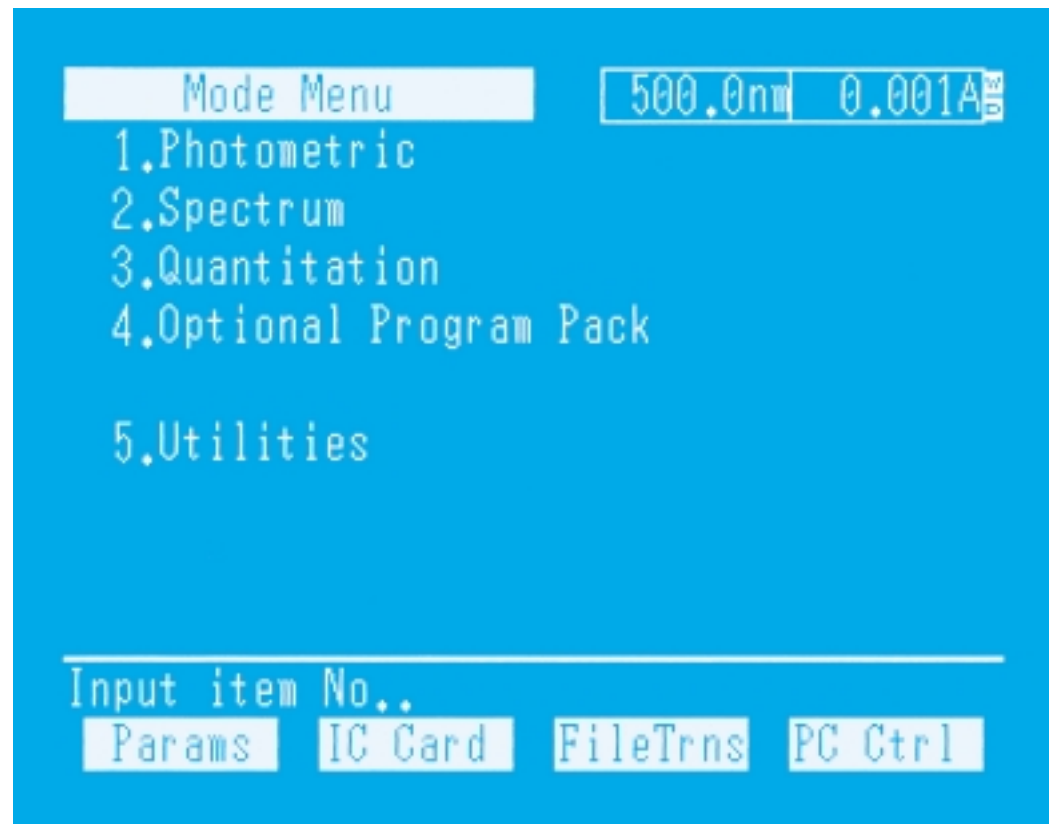

Photometric Mode for Fixed Wavelengths

With the photometric mode, you can measure the absorbance or transmittance at a fixed wavelength. Simple quantitative analysis using the K-factor method can also be used. Results are automatically printed or are sent to the RS-232C port. With the various optional cell positioners or sipper/autosampler configuration, continuous measurement of samples is also possible.

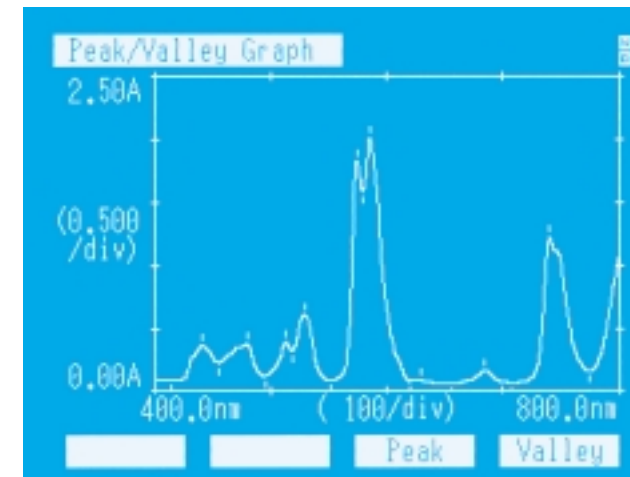
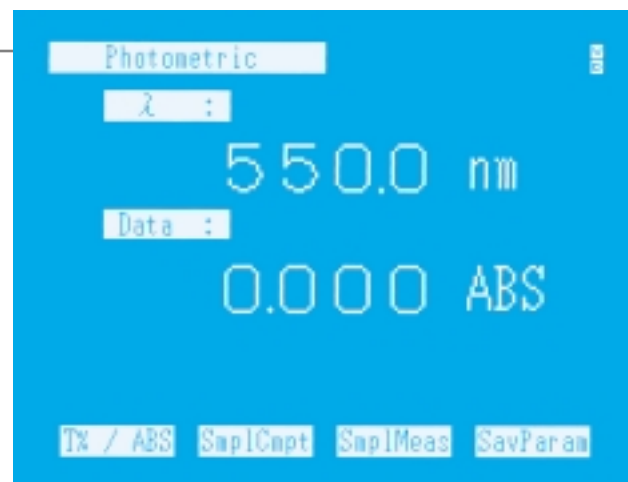

Spectrum Mode for Wavelength Scanning

With this standard mode, you can acquire a full UV-Visible spectrum of samples from 190nm to 1100nm. Repeat scan will allow you to measure any spectral change over the entire range automatically. Also available as standard is spectral data processing functions such as scaling the graph and peak/valley detection.

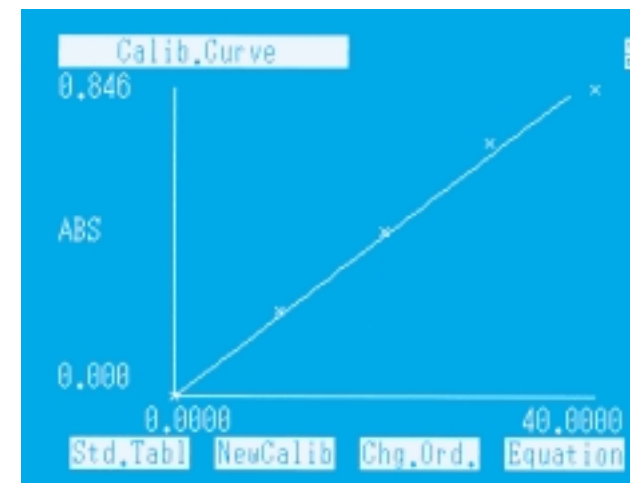

Quantitation Mode for Single Component Analysis

This mode will allow you to setup a calibration curve for easy determination of unknown sample concentrations. One, two or three-wavelength modes are available. Selectable quantitative methods included K-factor, one point or multi-point calibration curves. 1st, 2nd, or 3rd order fits are also selectable.

Print out

The measured spectrum can be printed out as a screen copy for quick display (left) or plotted for the best-printing resolution (right).

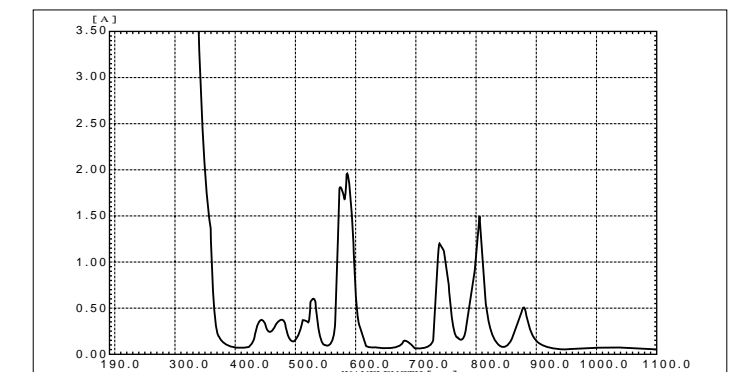
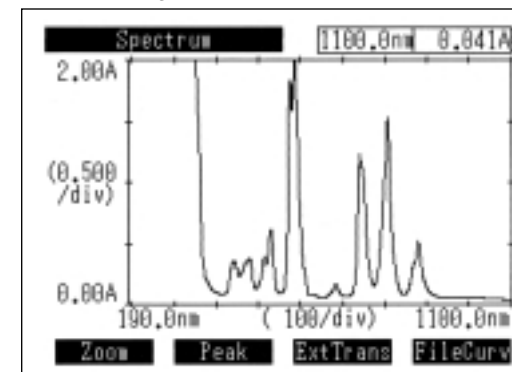

UV Data Manager Software (Cat.No.206-89765-92)

With the UV Mini connected to a PC via the standard RS-232C port, the UV Data Manager is the software designed to help organize and store data files in memory of a computer, the spectrophotometer or the data packs.

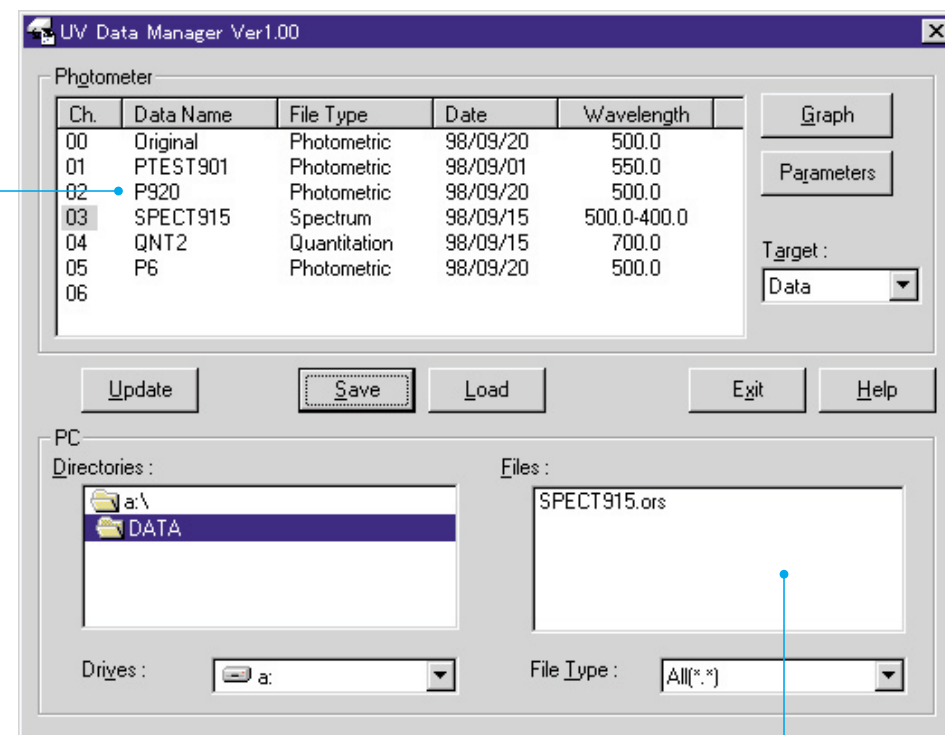

Data file list in memory of spectrophotometer and data pack

Data file list in directory of PC

Some of the features of the software include:

- Management of data and parameter files.
- Data translation from the spectrophotometer to the PC into a text file for easy pasting into a spreadsheet software package.
- Download previously saved data from the PC to the spectrophotometer for expanded storage and backup capabilities. Data can also be uploaded onto the IC data pack cards for multiple instrument users.
- Convenient sorting and searching possibilities for files in the data list box of the spectrophotometer, helping to maintain order of your essential information.
- Spectral data can be graphically displayed in the UV Data Manager to quick and easy data interpretation.

- Support files:
 - Photometric files
 - Spectrum files
 - Quantitation files
- *Optional program pack files are not available.

NOTE:
UV Data Manager is to be operated under MS-Windows 95/98/NT.
Use IBM-PC compatible personal computer.
Use Shimadzu RS-232C interface cable. The part number is 200-86408

DNA/Protein Program Pack (Cat.No.206-89750-92)

Concentration of DNA and protein is quickly calculated by using an optional program pack. The measurement wavelengths and the calculation are preprogrammed. Quantitative results are easily measured by simply setting the sample into the spectrophotometer and pressing START. Absorbance ratios and DNA/Protein calculations are readily available in the standard menu and the measurement wavelengths and factors can be modified to match your specific requirements.

Parameter setting display

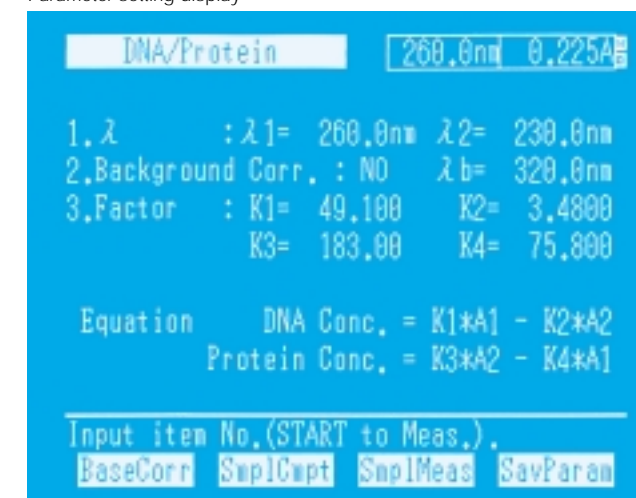

Measurement display

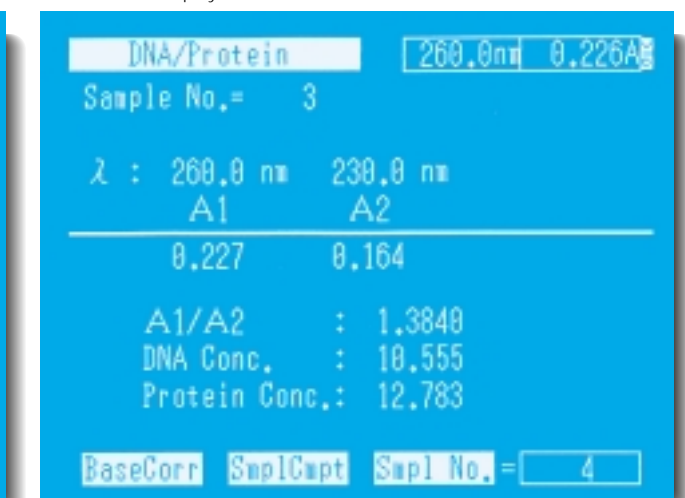

Concentration calculating formula is selectable between two types of formula as below.

1. A1=Absorbance at 260nm A2=Aborbance at 230nm
Ratio=A1/A2
DNA concentration=49.1 X A1-3.48 X A2
Protein concentration=183.0 X A2-75.8 X A1
2. A1=Absorbance at 260nm A2=Absorbance at 280nm
Ratio=A1/A2
DNA concentration=62.9 X A1-36.0 X A2
Protein concentration=1552.0 X A2-757.3 X A1

Selectable background correction for the absorbance at 320nm is available.
Reference:
1. Warburg and Christian, (1942) Biochem. Z. 310, 384-421.
2. Kalb and Bernlohr, (1077) Anal. Biochem. 20, 86-93.

Multiwavelength Measurement Program Pack (Cat. No. 206-89755-92)

This multiwavelength measurement program pack can measure up to six wavelengths. It can also simultaneously display the difference and ratio for two wavelengths in response to measured absorbances or transmittance rates as well as calculation results for three-wavelength calculation. It permits linked operation with the optional CPS cell positioner, to allow up to 6 samples to be measured concurrently.

- The wavelength program can be set for up to six wavelengths.
- Measuring data can be selected from two modes: absorbances or transmittances.
- Photometric values can be used for producing calculations.
 - 1) Ratio and difference of photometric values for two wavelengths
 - 2) Three-wavelength computation
 - 3) Four data formula computation: $(K1 \times A1 + K2 \times A2 + K3 \times A3 + K4 \times A4) \times K5$
 - 4) Four data formula computation: $K5 \times (K1 \times A1 + K2 \times A2) / (K3 \times A3 + K4 \times A4)$

An (n = 1 to 4) is the absorbance at measuring wavelength λ_n (n = 1 to 4). The same settings are possible for transmittance rates.
- Measurement results are printed out for each measurement.
- Sample exchange for each wavelength:

When one measurement is made, the sample can be exchanged for each wavelength so that the measurement can be taken.

Measuring Screen for Multiwavelength Measurement Pack

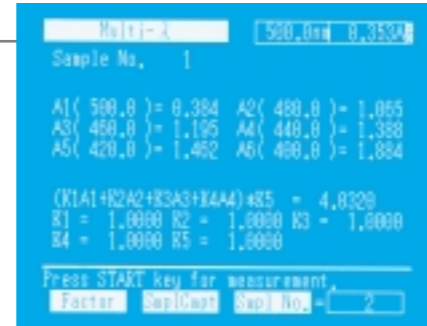

Calculation Formula Setting Screen for Multiwavelength Measurement Pack

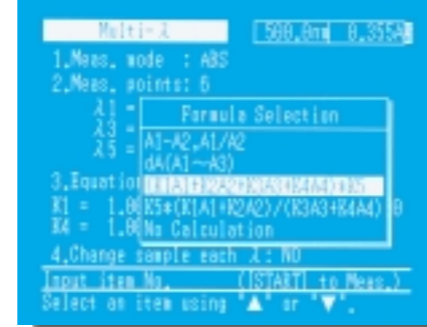

Activity Value Display Screen for Kinetics Program Pack



Kinetics Program Pack (Cat. No. 206-89756-92)

This software is used for measuring time change in absorbance at a constant wavelength and calculating enzyme activity values or other types of values.

- Calculation and recalculation of the activity value is possible through linear regression using the least-squares method.
- The coefficients used in the activity value calculation can be set to a maximum of four types.
- The setting range for measuring is from 1 to 6550 seconds (minutes).
- Measuring of two wavelengths is possible. Absorbance time change can be recorded while absorbance at the background wavelength is being extracted from absorbance at the measured wavelength.
- Data processing function for reaction curves:

Expansion and compression (Note that compression is possible only in the vertical axis.)
Data readout with the cursor key, Reaction curve storing and recall
- Measurement results (chart data) can be stored and recalled.

Time Scan Program Pack (Cat. No. 206-89757-92)

The time scan program pack can record the time change for photometric values (transmittance rates, absorbances and energy) at a constant wavelength. The state of change is displayed on screen as a time scan curve.

- Measuring data can be selected from three modes: absorbance, transmittance rate and energy.
- The setting range for measuring is from 1 to 6550 seconds (minutes).
- Data processing function for reaction curves:

Expansion and compression (Note that compression is possible only in the vertical axis.)
Data readout with the cursor key, Reaction curve storing and recall

Measuring Screen for Time Scan Program Pack

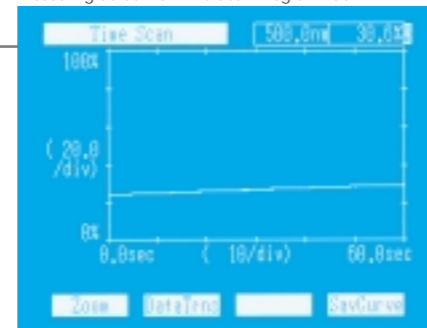

Condition Setting Screen (Lowry Method) for Protein Analysis Program Pack

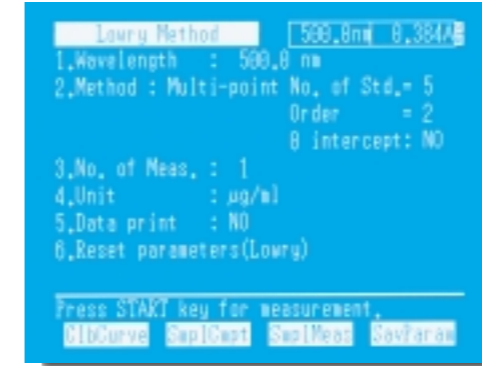

Item Selection Screen for Water Analysis Program Pack

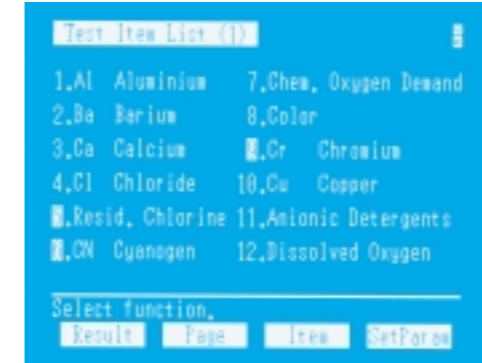

Operation Screen for Water Analysis Program Pack

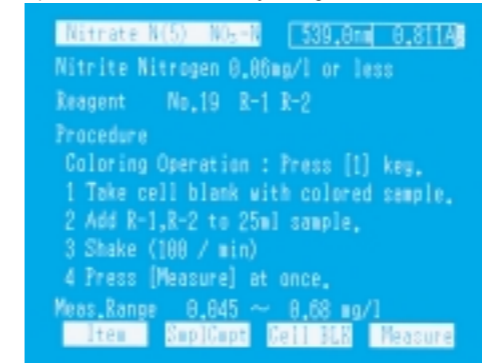

Measuring Screen for Water Analysis Program Pack



Protein Analysis Program Pack (Cat. No. 206-89758-92)

The protein analysis program pack is a single package that combines four quantitative methods for measuring protein concentrations using coloring reagents and a quantitative method for direct measurement of concentrations calculated from measured absorbances and absorption constants that have been set in advance.

- Quantitation Methods

Lowry method, BCA method (method using Bicinchoninic Acid)
CBB method (method using Coomassie Brilliant Blue G-250)
Biuret method, UV absorption method (280 nm)
- The calibration curve function is the same as the standard quantitation mode. (function using calorimetric method)
- Quantitation is possible from repeated measuring (1 to 10 measurements) together with those mean values.
- Measurement results (chart data) can be stored and recalled.

Water Analysis Program Pack (Cat. No. 206-89751-92)

Easy and accurate water analysis can be conducted in combination with simplified reagents.

- The number of analysis items are 55 items in 34 types, and all the analysis conditions are installed. Just select an item (including measurement of wavelength, calibration curve, measuring time, and measurement concentration range for each individual item) and it will be set automatically.
- Results can be acquired even without analytical knowledge through operation in accordance with screen instructions. The pack comes with an analysis guide which displays the number of the reagent to be used and the operation procedure, so there is no need to refer to the manual.
- If the optional multicell holder (6-cells) is used, up to six cells can be measured consecutively in one analysis.
- Automatic analysis commences after specified time. Elapsed time is displayed on screen, concentration values are displayed automatically after the specified time has elapsed, and a buzzer sounds to state that analysis is completed.

List of Measurable Items

Chemical symbol	Measurable item	Chemical symbol	Measurable item
Al	Aluminum	Ni	Nickel
Ba	Barium	NO ₂	Nitrite
Ca	Calcium	NO ₃	Nitrite-nitrogen
Cl	Chloride		Nitrate: Nitrate free
ClO	Residual chlorine: DPD method		Nitrate: Nitrate in 0.2 mg/l max.
	Residual chlorine: O-tolidine method		Nitrate: Nitrate in 0.2 mg/l min.
CN	Cyanogen: Free cyanogen		Nitrate-nitrogen: Nitrite-nitrogen free
	Cyanogen: Total cyanogen		Nitrate-nitrogen: Nitrite-nitrogen in 0.06 mg/l max.
COD	Chemical oxygen demand		Nitrate-nitrogen: Nitrite-nitrogen in 0.06 mg/l min.
Color	Color	Pb	Lead: Not including other metals
Cr	Chromium: Hexavalent chromium		Lead: Including other metals (KCN used)
	Chromium: Total chromium	pH	BCG
Cu	Copper		CPR
Det	Anionic detergent		BTB
DO	Dissolved oxygen		CRb
F	Fluorine	Phenol	Phenol
Fe	Iron (Ferrum): Divalent iron	PO ₄	Phosphate
	Iron (Ferrum): Divalent iron at low concentration	SiO ₂	Silica: High concentration
	Iron (Ferrum): Trivalent iron		Silica: Low concentration
	Iron (Ferrum): Total iron (oxidizing method)	Sn	Tin
	Iron (Ferrum): Total iron (reducing method)	SO ₄	Sulfite
	Iron (Ferrum): Total iron at low concentration	SO ₄	Sulfate
FOR	Formaldehyde	TH	Total hardness
H ₂ O ₂	Hydrogen peroxide	Turbid.	Turbidity
K	Potassium	Zn	Zinc: Not including other metals
Mg	Magnesium		Zinc: Including other metals (KCN used)
Mn	Manganese		
NH ₄	Ammonium		
	Ammonium nitrogen		

Hardware Specifications

Optical Design	Wavelength range	190.0~1100.0nm
	Display wavelength	0.1nm step
	Selectable wavelength	0.1nm step (1nm step in spectrum mode)
	Scan speed	wavelength change: approximately 3800nm/min. Scan: approximately 24~1400nm/min
	Light source change	Selectable from following 3 types: ●Auto change with wavelength Selectable wavelength 295nm~364nm: 1nm interval Recommended wavelength: 340nm ●Halogen lamp only ●Deuterium (D2) lamp only
	Measurement method	Single beam measurement
	Light source	Auto correction with the computer memory 20W Halogen lamp (long-life 2000 hours) Deuterium lamp (socket type) Auto adjustment for maximum sensitivity
	Monochromator	Incorporates aberration-correcting concave blazed holographic grating
Detector	Silicon photodiode	
Performance Specifications	Spectrum bandwidth	5nm
	Wavelength accuracy	± 1.0nm
	Wavelength repeatability	± 0.3nm
	Stray light	less than 0.05% (220.0nm NaI, 340.0nm NaNO ₂ & UV39)
	Photometric range	Absorbance: -0.3~3.0 Abs Transmittance: 0.0~200%
	Recording range	Absorbance: -3.99~3.99 Abs Transmittance: -399~399%
	Photometric accuracy	± 0.005 Abs (at 1.0 Abs) ± 0.003 Abs (at 0.5 Abs) NIST 930D filter
	Photometric repeatability	± 0.002 Abs (at 1.0 Abs)
	Drift	less than ± 0.001 Abs/h (after 2 hr warm-up)
	Baseline flatness	± 0.010 Abs (after 1 hr warm-up, at 1100~200nm)
	Noise	less than 0.002 Abs, Peak to Peak less than 0.0005 Abs, RMS
	Site Requirements	Sample compartment
Display		6 inch LCD (320 X 240 dot) with CFD lighting with contrast adjustment
Power supply		100~120V 50/60Hz 160VA 220~240V 50/60Hz 160VA
Dimensions		W416 X D379 X H274mm
Weight		11kg
Ambient temperature		15~35°C
Ambient humidity		45~80%, less than 70% if over 30°C

Software Specification

Photometric	<ul style="list-style-type: none"> ●Fixed wavelength measurement; T%, ABS ●Quantitation with K-factor method ●Save/Load of the result data table ●Auto printout of measured data, Auto transfer via serial port ●Optional cell positioners for continuous measurement of samples
Spectrum	<ul style="list-style-type: none"> ●Spectrum measurement <ul style="list-style-type: none"> ●Measuring mode: ABS, T%, E ●Scan Speed: Very fast, Fast, Medium, Slow, Very slow ●Scan times: 1~99 ●Spectrum display: Selectable overlay or sequential ●Data processing of spectrum data <ul style="list-style-type: none"> ●Detection of peak and valley (both up to 20) ●Zoom in and zoom out (only vertical axis can zoom out) ●Data read out with cursor keys ●Data save/load (Standard: 6, Data pack: 21) ●Spectrum data transfer via serial port ●Spectrum printout (A5 size, with ESC/P type printer)
Quantitation	<ul style="list-style-type: none"> ●1 wavelength, 2 or 3 wavelength quantitation ●Calibration curve <ul style="list-style-type: none"> K factor method with auto concentration calculation One point calibration curve with auto concentration calculation Multi-point calibration curve <ul style="list-style-type: none"> ●Number of standards (2~10) ●Calibration curve: 1~3 order calibration curve ●Selection to pass or not pass on original point Repeat measurement of standards (1-10 times) and creation of the calibration curve with the mean values of measurement data Display of the calibration curve Display of the correlation factor of the calibration curve ●Quantitation measurement <ul style="list-style-type: none"> Repetition (1~10 times) and the quantitation with the mean value ●Save/load of the measured data table ●Auto printout of the measured data, Auto transfer via serial port ●Optional cell positioners for continuous measurement of samples

HCP-1C Screen Copy Printer Kit (Cat. No. 206-89774-**)

Obtain screen copies of photometric data, plots, and tables by connecting this thermal printer to the spectrophotometer. The printer uses 11 cm wide thermal paper-just perfect to fit into any laboratory notebook. The printer cable are included.

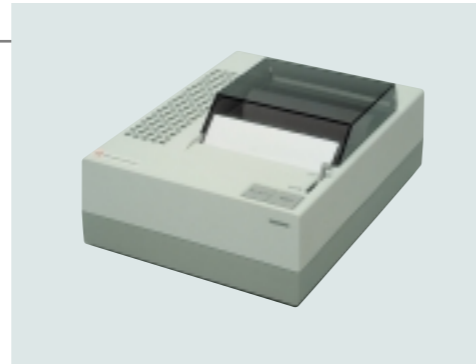

Centronics Interface Cable (Cat. No. 088-50904-20)

This option is necessary to connect a spectrophotometer to a commercially available printer. Almost any printer attached to a personal computer is capable of printing out digital data, but only some types of printers have the capability to hard-copy graphic images. The recommendable printers useful for this purpose is Seiko-Epson MJ 930C, LP-1800, or LX-800 compatible.

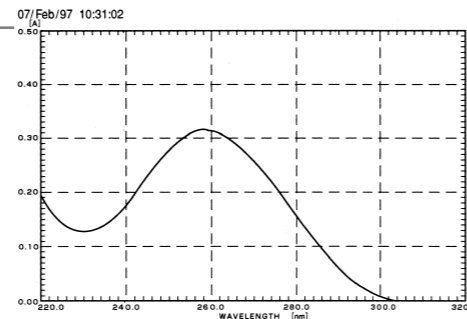

RS-232C Cable (Type 2) (Cat. No. 200-86408)

This cable is used to connect a spectrophotometer to an IBM-PC personal computer or compatible. The connection is made in the manner shown to the right.

- The cable has a 9-pin female connector on the PC side, and a 9-pin male connector on the spectrophotometer side.
- Only three lines are used for communication, two lines for signal input/output and one for grounding.
- The pins of the control lines on the PC side are connected so that signal input/output is always ready to be made from the PC side.

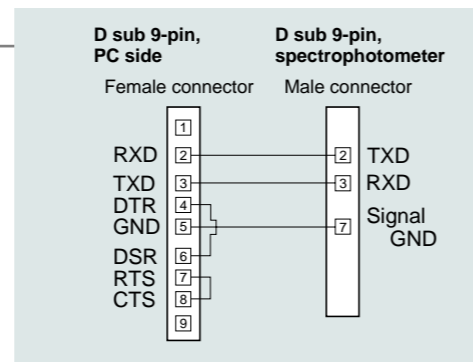

Alternate Sample Compartment (Cat. No. 206-60184)

It provides for additional sampling accessories such as the micro flow flow-thru cell, the long-path rectangular cell, the cylindrical cell, the film cell holder, and the constant-temperature cell.

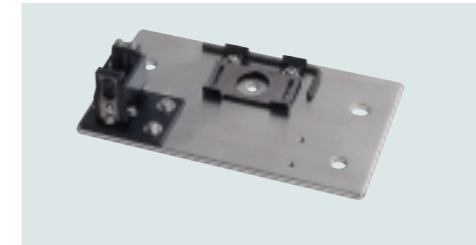

Supermicro Cell Holder (Cat. No. 206-14334-01)

Measure a sample minimum of 100 microliters with the supermicro cell holder. The holder facilitates the use of the masked microcell (Cat. No. 200-66578-11) for 100 to 120 μ L and supermicro cell (Cat. No. 200-66578-12) for quantities of 100 to 400 μ L. Requires the use of Alternate Sample Compartment (Cat. No. 206-60184).

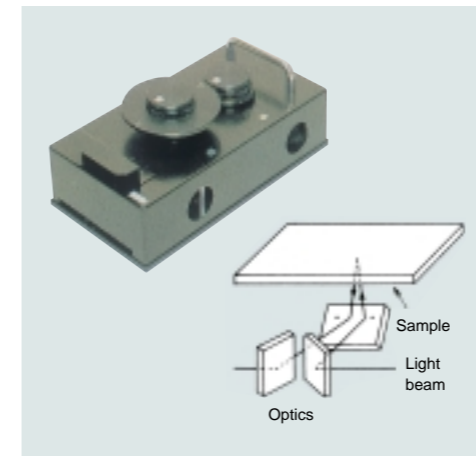

Specular Reflectance Measurement Attachment (5° incident angle) (Cat. No. 206-14046)

The technique of specular reflectance measurement is often utilized for evaluation of semiconductors and optical materials. The 5° incident angle minimizes the influence of polarized light. Thus, no polarizer is required in measurement the operation is quite simple.

- Samples as large as 100W \times 160D \times 15T mm can be readily measured, the minimum measuring area being 7 mm in diameter.
- Sample placement is quite easy - just set it on the holder with the measuring face down.
- The Spectrum Program Pack is necessary for recording reflection spectra.
- Use of the Film Thickness Measurement Program Pack provides reflection spectra of thin film samples and calculation of film thickness. Requires Alternate Sample Compartment (Cat. No. 206-60184).



CPS-240A Cell Positioner, thermoelectrically temperature controlled (Cat. No. 204-05837-**)

Supports time course monitoring of up to 6 samples. The CPS-240A permits measurement of up to six sample cells under constant-temperature conditions.

This provides printout of absorbance changes of up to six samples during the set length of time at the selected constant temperature.

- Number of sample cells: 6
 - Temperature control range: 16 to 60°C
 - Temperature display accuracy (difference from the true value): $\pm 0.5^\circ\text{C}$
 - Temperature control precision (variation of temperature) $\pm 0.1^\circ\text{C}$
 - Ambient temperature: 15 to 35°C
- Sample cells (Cat. No. 200-34442) are not included in the standard content of the CPS-240A.

OPTIONAL ACCESSORIES

Micro Flow-Thru Cell with holder—10mm (Cat. No. 204-06222)

Provides 10 mm pathlength flow-thru cell and holder with an inner volume of 0.3 mL. Requires Alternate Sample Compartment (Cat. No. 206-60184).

Micro Flow-Thru Cell with a holder—5 mm (Cat. No. 204-06222-01)

Provides 5 mm pathlength flow-thru cell and holder with an inner volume of 0.15 mL. Requires Alternate Sample Compartment (Cat. No. 206-60184).

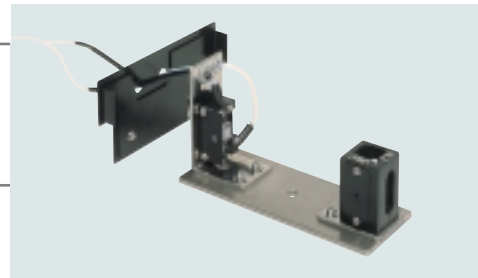

Constant-Temperature Cell Holder (Cat. No. 202-30858-04)

Maintains a sample cell at a desired, uniform temperature by circulating constant-temperature water.

- Temperature range: 5 to 90°C (depends on the performance of the constant-temperature water circulator)
- Cell holder: Accepts a 10 mm square cell

Note: The Alternate Sample Compartment (Cat. No. 206-60184) is necessary.

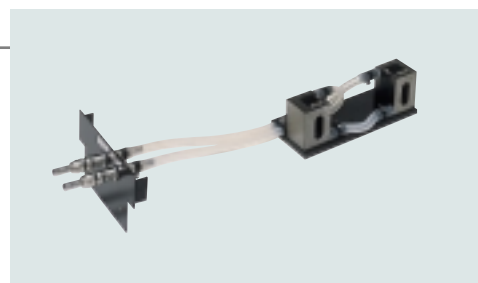

Constant-Temperature Four-Cell Holder (Cat. No. 204-27206-02)

Maintains four sample cells at a desired, uniform temperature by circulating constant-temperature water.

- Temperature range: 5 to 90°C
- Accepts four 10 mm sample cells.

Note: The Four Cell Sample Compartment Unit (Cat. No. 204-00850-01) is necessary.

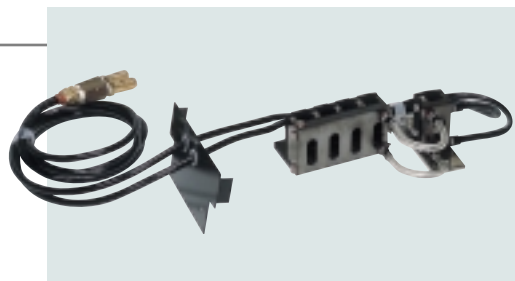

Long-Path Rectangular Cell Holder (Cat. No. 204-23118-01)

Provides holder for rectangular cells having an optical path of 10, 20, 30, or 50 mm.

Note: The Alternate Sample Compartment (Cat. No. 206-60184) is necessary.



Universal Rectangular Cell Holder, four-cell type (Cat. No. 204-27208)

Provides manual changer for rectangular cells having an optical path of 10, 20, 30, or 50 mm.

Note: The Four Cell Sample Compartment Unit (Cat. No. 204-00850-01) is necessary.

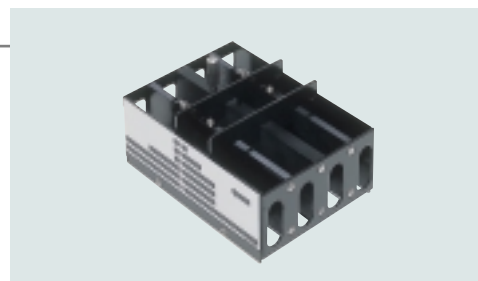

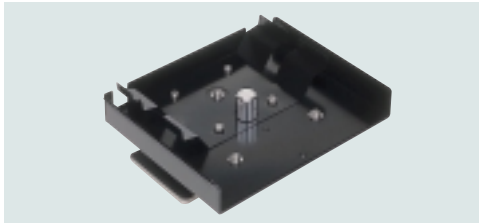

Cylindrical Cell Holder (Cat. No. 204-06216-02)

Provides Holder for a cylindrical cell having an optical path of 10, 20, 50, or 100 mm.

Note: The Alternate Sample Compartment (Cat. No. 206-60184) is necessary.

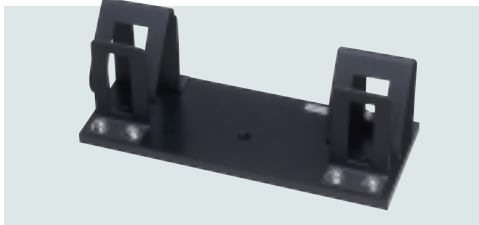

Film Holder (Cat. No. 204-58909)

Provides holder for measurement of thin samples such as films and filters.

Note: The Alternate Sample Compartment (Cat. No. 206-60184) is necessary.



Front Panel with holes (Cat. No. 204-27588-03)

This panel allows the tubes of a flow-thru cell, for example, to be connected through the panel.

Note: The Alternate Sample Compartment (Cat. No. 206-60184) is necessary.

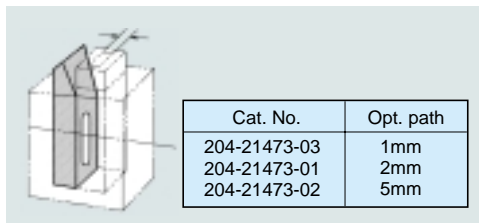

Spacer for Short-Path Cell (Cat. No. 204-21473-**)

Samples too dense to be measured with a standard 10 mm square cell can be measured reliably without dilution by means of a short-path cell.

The spacers are available for three types of cells corresponding to a path length of 1, 2, or 5 mm. As shown in the figure, the spacer is sandwiched between the cell and the inner wall of the square cell holder.

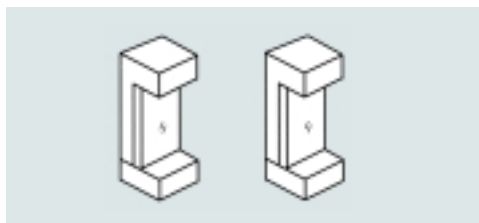

Didymium Filter (Cat. No. 202-30242)

Holmium Filter (Cat. No. 202-30242-05)

These filters are used to check the instrument.

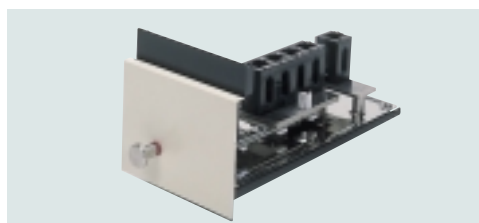

Four-Cell Sample Compartment Unit with holder (Cat. No. 204-00850-01)

Provides manual sample changer with 4 holders for 10 mm square cells. Cells are on a sliding mount which moves by manual changing. Requires Alternate Sample Compartment. This option accepts other four-cell holders.



ASC-5 Auto Sample Changer (Cat. No. 204-09100)

Combine with a Sipper 160 to build an automated multisample spectrophotometry system.

- The aspirating nozzle is programmed to move in the X, Y, and Z (vertical) directions.
- Up to 8 sets of operational parameters, including the size of racks and the number of test tubes, may be memorized in the battery back-up protected files.
- An RS-232C interface (Cat. No. 204-09079) is optionally available for a computer to control the ASC-5 directly.
- Up to 100 test tubes may be set together on the rack.

Note: A commercially available test tube stand, with a footprint smaller than 220 × 220 mm, is applicable. Requires a sipper.

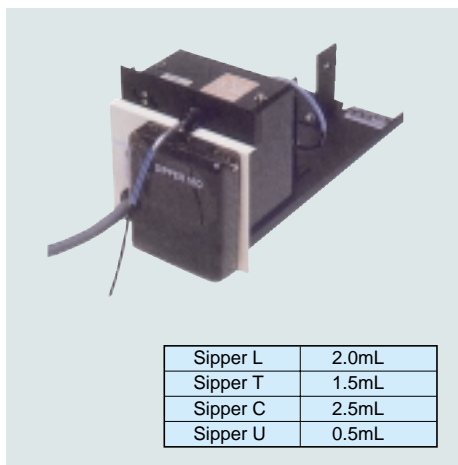

Sipper 160L (Cat. No. 204-08270-01)

Single pass, 10 mm light path, and 2 mL volume.

Sipper 160T (Cat. No. 204-08270-02)

Triple pass, 10 mm light path, and 1.5 mL volume.

Sipper 160C (Cat. No. 204-08270-03)

Provided with a constant-temperature jacket, 10 mm light path, and 2.5 mL volume.

Sipper 160U (Cat. No. 204-08270-04)

Supermicro type, single pass, 10 mm light path, and 0.5 mL volume.

- The stepping motor-driven peristaltic pump ensures reliable and smooth aspiration of sample solution. (No interface required.)

Note: Use of a Teflon valve unit (Cat. No. 204-06599-01) is recommended when strong acids, strong alkalis, or organic solvents are to be measured. (The Sample Waste Unit (Cat. No. 204-29230) is necessary.)

Sipper L	2.0mL
Sipper T	1.5mL
Sipper C	2.5mL
Sipper U	0.5mL



TCC-240A Thermoelectrically Temperature-Controlled Cell Holder (Cat. No. 204-05557-01)

Use Peltier effect for controlling the sample temperature, so no thermostatic bath or cooling water is required.

- Number of cells: One each on the sample and reference sides.
(The reference side is not used in the UVmini-1240.)
- Temperature range: 7 to 60°C
- Temperature display accuracy (difference from the true value): ± 0.5°C
- Temperature control precision (variation of temperature): ± 0.1°C

Note: Cells (Cat. No. 200-34442) are not included in the standard content.

CELLS (Option)

Description	Optical path (ℓ)	Type	Fused silica (S) Cell	Glass (G) Cell
Square cell	10mm	①	200-34442	200-34565
	20mm	⑥	200-34446	200-34446-01
	50mm	⑥	200-34944	200-34944-01
Square cell with stopper	10mm	②	200-34444	200-34444-01
Semi-micro cell	10mm	③	200-66501	200-66501-01
Semi-micro black cell	10mm	③'	200-66551	—
Super micro black cell	10mm	⑦	200-66578-11	—
	5mm	⑦'	208-92116	—
Micro black cell	10mm	⑧	200-66578-12	—
Cylindrical cell	10mm	④	200-34448 (silica window)	200-34448-01 (glass window)
	20mm		200-34472 (silica window)	200-34472-01 (glass window)
	50mm		200-34473-01 (silica window)	200-34473-03 (glass window)
	100mm		200-34473-02 (silica window)	200-34473-04 (glass window)
Short path cell	1mm	⑤	200-34660-01	200-34662-01
	2mm		200-34655	200-34662-11
	5mm		200-34449	200-34449-01

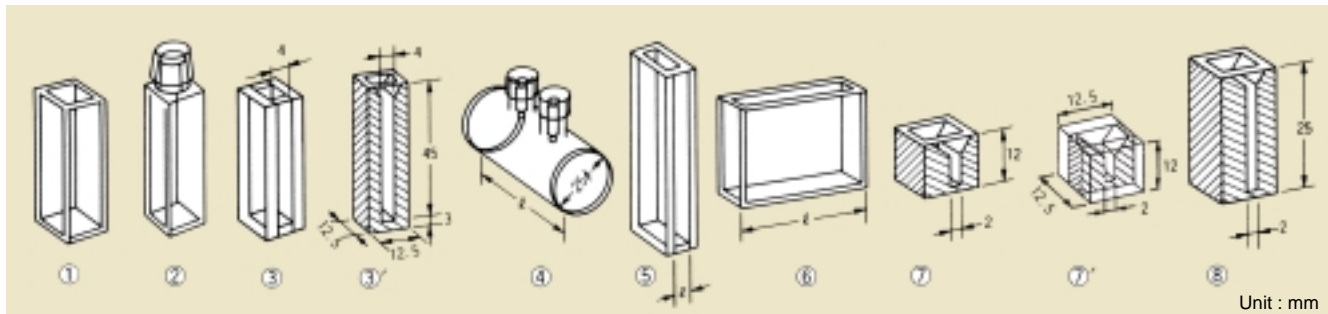

SHIMADZU CORPORATION. International Marketing Division

3. Kanda-Nishikicho 1-chome, Chiyoda-ku, Tokyo 101-8448, Japan Phone: 81(3)3219-5641 Fax: 81(3)3219-5710
Cable Add.: SHIMADZU TOKYO

SHIMADZU SCIENTIFIC INSTRUMENTS, INC.

7102 Riverwood Drive, Columbia, Maryland 21046, U.S.A.
Phone: 1(410)381-1227 Fax: 1(410)381-1222 Toll Free: 1(800)477-1227

SHIMADZU DEUTSCHLAND GmbH

Albert-Hahn-Strasse 6-10, D-47269 Duisburg, F.R. Germany Phone: 49(203)7687-0 Fax: 49(203)766625

SHIMADZU (ASIA PACIFIC) PTE LTD.

16 Science Park Drive #01-01 Singapore Science Park, Singapore 118227, Republic of Singapore
Phone: 65-778 6280 Fax: 65-779 2935

SHIMADZU SCIENTIFIC INSTRUMENTS (OCEANIA) PTY. LTD.

Units F, 10-16 South Street Rydalmere N.S.W. 2116, Australia
Phone: 61(2)9684-4200 Fax: 61(2)9684-4055

SHIMADZU DO BRASIL COMERCIO LTDA.

Rua Cenzo Sbrighi, 25, Agua Branca, Sao Paulo, CEP 05036-010, BRAZIL
Phone: (55)11-3611-1688 Fax: (55)11-3611-2209

SHIMADZU (HONG KONG) LIMITED

Suite 1028 Ocean Center, Harbour City, Tsim Sha Tsui, Kowloon HONG KONG
Phone: (852)2375-4979 Fax: (852)2199-7438

Overseas Offices

Istanbul, Beijing, Shanghai, Guangzhou, Shenyang, Chengdu, Moscow

URL <http://www.shimadzu.com>

The contents of this catalog are subject to change without notice.

Printed in Japan 3295-04302-30A-1K