

# Intelligent Evaporation



... takes the **thinking** out  
of your **work**

# Technical Specifications - Rotary Evaporators

Model	Hei-VAP Value (HL)	Hei-VAP Advantage (HL)	Hei-VAP Advantage (ML)	Hei-VAP Precision (HL)	Hei-VAP Precision (ML)
Hand / Motor lift	hand lift	hand lift	motor lift	hand lift	motor lift
Height adjustment speed	manual	manual	30 mm/s	manual	30 mm/s
Height adjustment (mm)	155	155	155	155	155
Rotation speed (rpm)	20 - 280	20 - 280	20 - 280	20 - 280	20 - 280
Rotation speed setting	scale	3.5" LCD display	3.5" LCD display	4.3" color graphic display	4.3" color graphic display
Drive	brushless DC motor with electronic speed control				
Heating capacity (W)	1300	1300	1300	1300	1300
Temp. range heating bath (°C)	20 - 210	20 - 210	20 - 210	20 - 210	20 - 210
Temperature accuracy bath (°C)	± 1	± 1	± 1	± 1	± 1
Overheat protection bath (°C)	cut-off at 5 °C over set temperature via separate PT 1000				
Bath temperature setting	scale	3.5" LCD display	3.5" LCD display	4.3" LCD color graphic display	4.3" LCD color graphic display
Heating bath temperature control	electronic/digital	electronic/digital	electronic/digital	electronic/digital	electronic/digital
Secondary overtemp. cut-off (°C)	250	250	250	250	250
Material heating bath	stainless steel AISI 316L	stainless steel AISI 316L	stainless steel AISI 316L	stainless steel AISI 316L	stainless steel AISI 316L
Diameter heating bath (mm)	255	255	255	255	255
Volume heating bath (l)	4.5	4.5	4.5	4.5	4.5
Display vapor temperature required accessories	no	yes vapor temperature sensor	yes vapor temperature sensor	yes vapor temperature sensor	yes vapor temperature sensor
Integrated vacuum controller	no	no	no	yes	yes
Timer	no	yes	yes	yes	yes
Vacuum program Set <sub>pressure</sub> **	no	no	no	yes	yes
Vacuum program AUTO <sub>easy</sub> **	no	no	no	yes	yes
Vacuum program AUTO <sub>accurate</sub> ** requires AUTO <sub>accurate</sub> -sensor	no	no	no	yes	yes
Remote control function					
- Lift	no	no	yes	no	yes
- Start rotation	yes	yes	yes	yes	yes
- Start vacuum	no	no	no	yes	yes
- Start heating bath	yes	yes	yes	yes	yes
Programmable ramps	no	no	no	yes	yes
Supply power (W)	1400	1400	1400	1400	1400
Weight (kg) (without glass assembly)	16	16	16	17	17
Size (l x w x h) (mm)	395 x 490 x 430	395 x 490 x 430	395 x 420 x 430	395 x 490 x 430	395 x 420 x 430
Protection class**** (DIN EN 60529)	IP 20	IP 20	IP 20	IP 20	IP 20
Operation conditions (°C)	0 - 40 at 80 % rel. humidity	0 - 40 at 80 % rel. humidity	0 - 40 at 80 % rel. humidity	0 - 40 at 80 % rel. humidity	0 - 40 at 80 % rel. humidity
Rate of evaporation (L/h) ΔT* 20/40 °C					
- Toluene	4.1 / 8.2	4.1 / 8.2	4.1 / 8.2	4.1 / 8.2	4.1 / 8.2
- Acetone	2.4 / 4.7	2.4 / 4.7	2.4 / 4.7	2.4 / 4.7	2.4 / 4.7
- Ethanol	1.6 / 3.2	1.6 / 3.2	1.6 / 3.2	1.6 / 3.2	1.6 / 3.2
- Water	0.5 / 1.0	0.5 / 1.0	0.5 / 1.0	0.5 / 1.0	0.5 / 1.0
Condensing surface (cm <sup>2</sup> )	1200	1200	1200	1200	1200
Supply voltage *** (V/Hz)	230 V / 50/60 Hz 115 V / 60 Hz	230 V / 50/60 Hz 115 V / 60 Hz	230 V / 50/60 Hz 115 V / 60 Hz	230 V / 50/60 Hz 115 V / 60 Hz	230 V / 50/60 Hz 115 V / 60 Hz

\* ΔT = Difference between heating bath temperature and boiling temperature

\*\*\* Standard 230 V / 50/60 Hz: Others upon request, please specify for order

\*\* Only in combination with vacuum systems

\*\*\*\* IP 67 cable connection on heating bath

## While you concentrate on research, we'll look after your support needs

As we want you to have more time to thoroughly concentrate on research, the whole Heidolph team enthusiastically provides you with extensive support and helps to reduce your workload.

- 24 hour service for all inquiries
- Individual application support
- Short delivery time for standard items
- After sales service provided by your local dealer
- More than 80 distributors worldwide
- Priority technical service
- Long-lasting service life of all products due to corrosion-resistant electronics and maintenance-free motors
- 3 year warranty

## Intelligent Evaporation



- Up to 30 % Time Savings
- Industry Leading Safety Features
- Remote Operation Standard

**Reduced Process Times**

### Summary:

Your advantages of the Hei-VAP Series	Page 4-7
Hei-VAP Value	Page 8
Hei-VAP Advantage	Page 9
Hei-VAP Precision	Page 10-11
The Modular Concept	Page 12
Reduced process times	Page 13
Glassware	Page 14
Accessories	Page 15-16
Vacuum Systems	Page 17-20
Equipment Combinations	Page 21
Chillers	Page 22
Overview	Page 23
Configuration Tool	Page 24
Complete Packages	Page 24-25



## Hei-VAP Series

The Hei-VAP Series is **THE** ultimate answer to your requirements.



## Operating Panel

Is safety, convenience and flexibility a top priority for you?  
The detachable operating panel offers all in one.

Changing all parameters outside the closed fume hood guarantees the highest **safety** level

**Immediate** access to the panel ensures ultimate control of the process while increasing your ease of use

**Hei-GUIDE**, the button with a turn & push function navigates you easily through the menu



Standard for all models is a panel with 1.3 m cable connection. Thus **data security** is guaranteed at any time

An optional remote control operating panel allows you to step away from the evaporator and still monitor all process data increasing your **flexibility** at work

## Vapor tube

Is safety, convenience, cost savings and time a top priority for you?

**Immediate** removal of the vapor tube from the drive facilitates your work

Highest **safety**: The Hei-VAP vapor tube does not get stuck in the drive eliminating broken glass

The vapor tube removes easily from the drive and is designed for **years of service life**. Patent pending

Years of performance life **reduces your spare parts budget** up to 75 %



# Your advantages - our Hei-lights

## For your safety

- Two independent safety circuits **avoid an overheat situation** of your heating bath: If bath temperature overshoots by 5 °C and if your water bath runs dry heating will be switched off automatically
- To avoid an over temperature situation and potential thermal damage to your sample, you can pre-program on the Precision model a max. SET temperature individually **at which the bath shuts off**
- In case of a power-cut, all motor lift models will remove the flask from the heating bath **preventing safety hazards** and potential thermal damage to your sample
- **To protect you from splashes and scalding** the Hei-VAP heating bath features a pour spout to remove bath fluid safely
- Heating bath is constructed with a **double wall** for your protection against burns and scalding
- The guard hood **covers the entire bath completely** even if the heating bath is adjusted horizontally to its most extreme limit
- **To prevent short-circuits and systematic corrosion** from your heating bath, the electrical cable coupling complies with the high protection class IP 67
- For your protection the operating panel is located near the base and **keeps your hands out of the dangerous zone** of rotating flasks, steam and splashing bath fluids
- All heating baths feature **non-slip handles** with safety grip to protect you from scalding bath liquids and allow for easy installation/removal of the bath
- A separate on/off switch for heating **prevents an unintentional heat up**. If heating is switched on the on/off button is illuminated for visual control
- In case of an overshoot of any parameter setting, all models will show a **warning on the operating panel**
- Glassware assemblies are optionally available with **transparent plastic safety coating** ensuring ultimate protection while allowing visual control at all times

## For your ease of use:

- The detachable operating panel can be attached via Velcro or with a special suspension at eye level for your convenience **outside of closed fume hoods**
- Standard for all models is a panel with 1.3 m cable connection for **increased flexibility and safety**. An optional wireless panel is available for all Precision models early 2010. All previously purchased units can be upgraded
- The evaporating flask **clamp can not be lost** due to a connection to the vapor tube coupling ring
- A flask ejector feature of the vapor tube coupling ring allows you to **remove sticking evaporating flasks** from the vapor tube just in seconds in a safe manner
- The universal heating bath can be adjusted horizontally up to 200 mm and offers efficient space to **accommodate even 5 liter flasks**
- For your convenience the height (160 mm) and the angle of the evaporating flask can be **adjusted easily from 20° to 80°**



## Sustainable economic benefits - increased efficiency

- **Reduce your process times** depending on your model and periphery up to 30 %
- The chemically resistant vacuum seal **reduces your spare parts budget** up to 75 % with prolonged operational lifespan
- **Savings** at the same high level are possible due to the long service life vapor tube
- Increase your range of applications by using 5 liter flasks in the universal bath **at no added costs**
- A new coating formula **prevents corrosion** effectively
- The flange on the condenser side of the drive is made of PPS (Poly Phenylene Sulfide), a **robust industrial designer resin** with superior chemical resistance, and thus provides more chemical resistance than stainless steel or milled aluminium. That reduces corrosion to a minimum which results in additional savings on maintenance and replacement components associated with corrosion effects of moisture condensation from condenser coupled with common corrosive reagents used in daily laboratory activities
- Only Hei-VAP heating baths **reach a temperature of 210 °C** which is 30 °C higher than other evaporators on the market and allow for a broader range of applications which previously could not be performed on any rotary evaporator. Thus increasing the range of applications eliminates the need for investments in other equipment
- Reduce your maintenance costs. The sealed housing protects your rotary evaporator from aggressive fumes, liquids and vapors to prevent internal corrosion. This results in an **increased lifespan of 10 years** on average at a reduced maintenance and repair cost

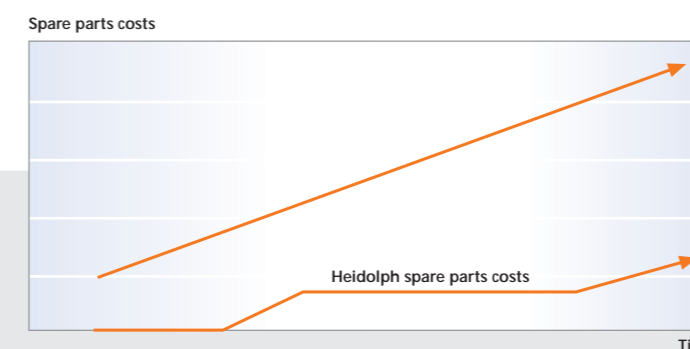

## Hei-VAP Value

### Affordable model with hand lift for all standard applications

- Includes all standard Hei-VAP features for safety, ease of use and economic benefits plus:
- The convenience of large dial controls for adjustment of rotation speed and bath temperature
- For limited budgets we recommend the optional manual vacuum controller
- For precise vacuum control and reproducible results we recommend the optional digital vacuum controller
- Hei-VAP Value models have no digital display



Hei-VAP Value HL/G3  
P/N 560-01300-00

## Hei-VAP Advantage

### For your routine distillation applications and reproducible results

- Includes all standard Hei-VAP features for safety, ease of use and economic benefits plus:
- Available in hand lift or motor lift configurations
- Experience the advantages of our large digital 3.5" LCD display which indicates rotation speed, heating bath and vapor temperature
- For limited budgets we recommend the optional manual vacuum controller
- For precise vacuum control and reproducible results we recommend the optional digital vacuum controller
- Experience the advantages of the automatic process timer which turns off your evaporator at a pre-programmed time and removes evaporating flasks from bath on motor lift models
- Upgrade your Hei-VAP Advantage to a Hei-VAP Precision:

Upgrade-KIT Advantage Precision-HL:  
P/N 569-30009-00  
Upgrade-KIT Advantage Precision-ML:  
P/N 569-40009-00



Hei-VAP Advantage ML/G3  
P/N 562-01300-00

Models	Glassware	Hand lift (HL)	
		standard	coated
Hei-VAP Value	G1 Diagonal	560-01100-00	560-01110-00
Hei-VAP Value	G3 Vertical	560-01300-00	560-01310-00
Hei-VAP Value	G5 Dry Ice Condenser	560-01500-00	560-01510-00
Hei-VAP Value	G6 Vertical for Reflux	560-01600-00	560-01610-00

Models	Glassware	Hand lift (HL)		Motor lift (ML)	
		standard	coated	standard	coated
Hei-VAP Advantage	G1 Diagonal	561-01100-00	561-01110-00	562-01100-00	562-01110-00
Hei-VAP Advantage	G3 Vertical	561-01300-00	561-01310-00	562-01300-00	562-01310-00
Hei-VAP Advantage	G5 Dry Ice Condenser	561-01500-00	561-01510-00	562-01500-00	562-01510-00
Hei-VAP Advantage	G6 Vertical for Reflux	561-01600-00	561-01610-00	562-01600-00	562-01610-00

# Hei-VAP Precision

## Most demanding applications and the finest integrated vacuum control capabilities

- Includes all standard Hei-VAP features for safety, ease of use and economic benefits plus:
- Available in hand lift or motor lift configurations
- Experience the advantages of our large 4.3" color graphic display which features all parameters, integrated vacuum controller and includes programs for automated distillations
- Make your life easier by utilizing the integrated software support which leads you through the capabilities of the evaporator
- For data management Hei-VAP Precision models feature a USB interface

- Save time by configuring the unit - all connected components and periphery devices will be recognized by the evaporator which eliminates the need to configure the unit manually
- Now you can manage even the most demanding applications easily and prevent foaming, excessive bubbling or bumping
- Save time with your individualized pre-programmed parameter settings for your most common applications on a daily basis by saving them as a ramp in memory
- Apply an individual name for those ramps to avoid a mix-up
- Experience the advantages of the automatic process timer which turns off your evaporator at a pre-programmed time by raising the flask on motor lift models and releasing vacuum
- Control your process individually by pre-programming vacuum gradients
- Hei-VAP Precision models feature a built-in vacuum controller as a standard



Large color graphic display for all parameters and automated programs

Save your common applications under an individual name

Even from a distance you will be able to monitor the numbers on the display easily

For increased safety, all bath temperature adjustments can be limited

Hei-VAP Precision ML/G3  
P/N 564-01300-00

A separate on/off switch for heating prevents an unintentional heat up. If heating is switched on the on/off button is illuminated for visual control

## Programs facilitate process control

Reduce your process times significantly by using these three programs for automated distillation

### SET<sub>pressure</sub>

Program for solvent separations. This program holds a set vacuum constant. During the evacuation you have the full flexibility to choose any other level of vacuum by the press of a button

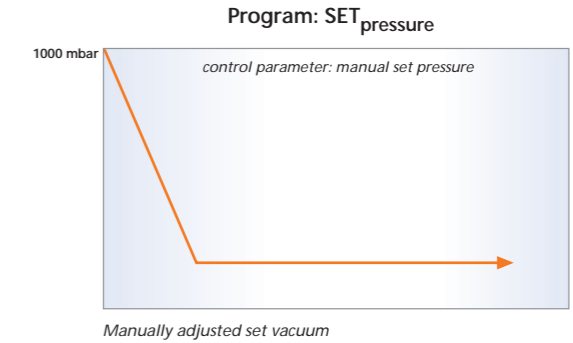

### Program: AUTO<sub>easy</sub>

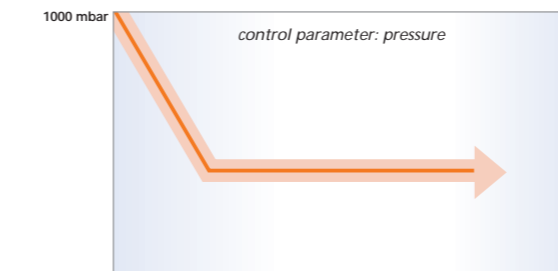

### AUTO<sub>easy</sub>

Supports the automatic pressure control for solvent separations. The pressure level for the first boiling point is found automatically. This program can be used with all Heidolph glassware assemblies and does not require any accessories

### AUTO<sub>accurate</sub>

Supports very precise automatic pressure control for solvent separations. This program works similar to AUTO<sub>easy</sub> but in addition is able to identify multiple boiling points automatically by reducing vacuum accordingly. Also the AUTO<sub>accurate</sub> program delivers the finest and most precise vacuum control. To take advantage of this program the optional AUTO<sub>accurate</sub>-sensor is required. Also this program can not be used on Heidolph G1 and G5 glassware assemblies. Leading parameter of this program is the vapor temperature (AUTO<sub>accurate</sub> is a combination of the previous programs T<sub>auto</sub> and P<sub>auto</sub>)

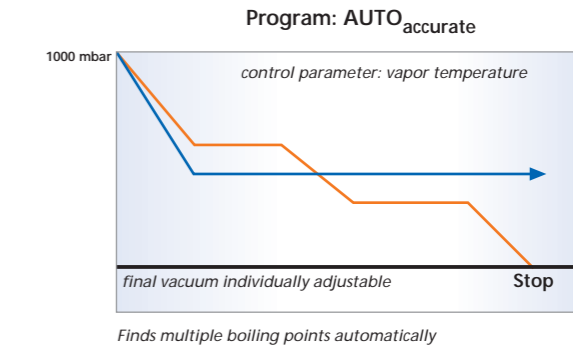

➔ Reduce your process times via automated distillation programs

Models	Glassware	Hand lift (HL)		Motor lift (ML)	
		standard	coated	standard	coated
Hei-VAP Precision	G1 Diagonal	563-01100-00	563-01110-00	564-01100-00	564-01110-00
Hei-VAP Precision	G3 Vertical	563-01300-00	563-01310-00	564-01300-00	564-01310-00
Hei-VAP Precision	G5 Dry Ice Condenser	563-01500-00	563-01510-00	564-01500-00	564-01510-00
Hei-VAP Precision	G6 Vertical for Reflux	563-01600-00	563-01610-00	564-01600-00	564-01610-00

# The Modular Concept

The Modular Concept consists of rotary evaporator, vacuum pump, controller and chiller

- All components are technically designed to function together perfectly
- Self contained system eliminates the need for water, dry ice and vacuum source
- For higher requirements, you can upgrade your Hei-VAP model at any time
- Heidolph offers you a complete system available from one manufacturer
- Use your space in your lab efficiently: The Modular Concept has a footprint of 470 x 580 mm only



# The reason why you can reduce your process times up to 30 %

Most precise vacuum due to fully automatic speed control

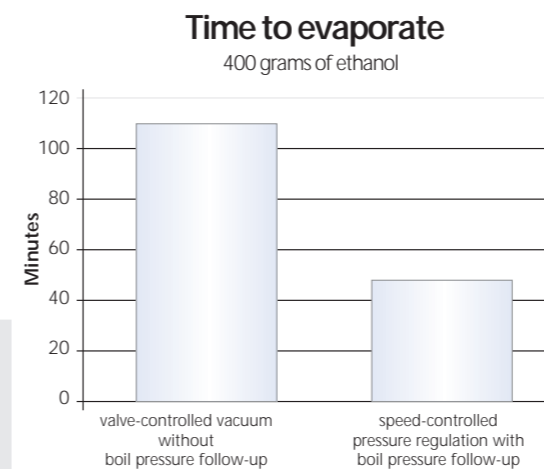
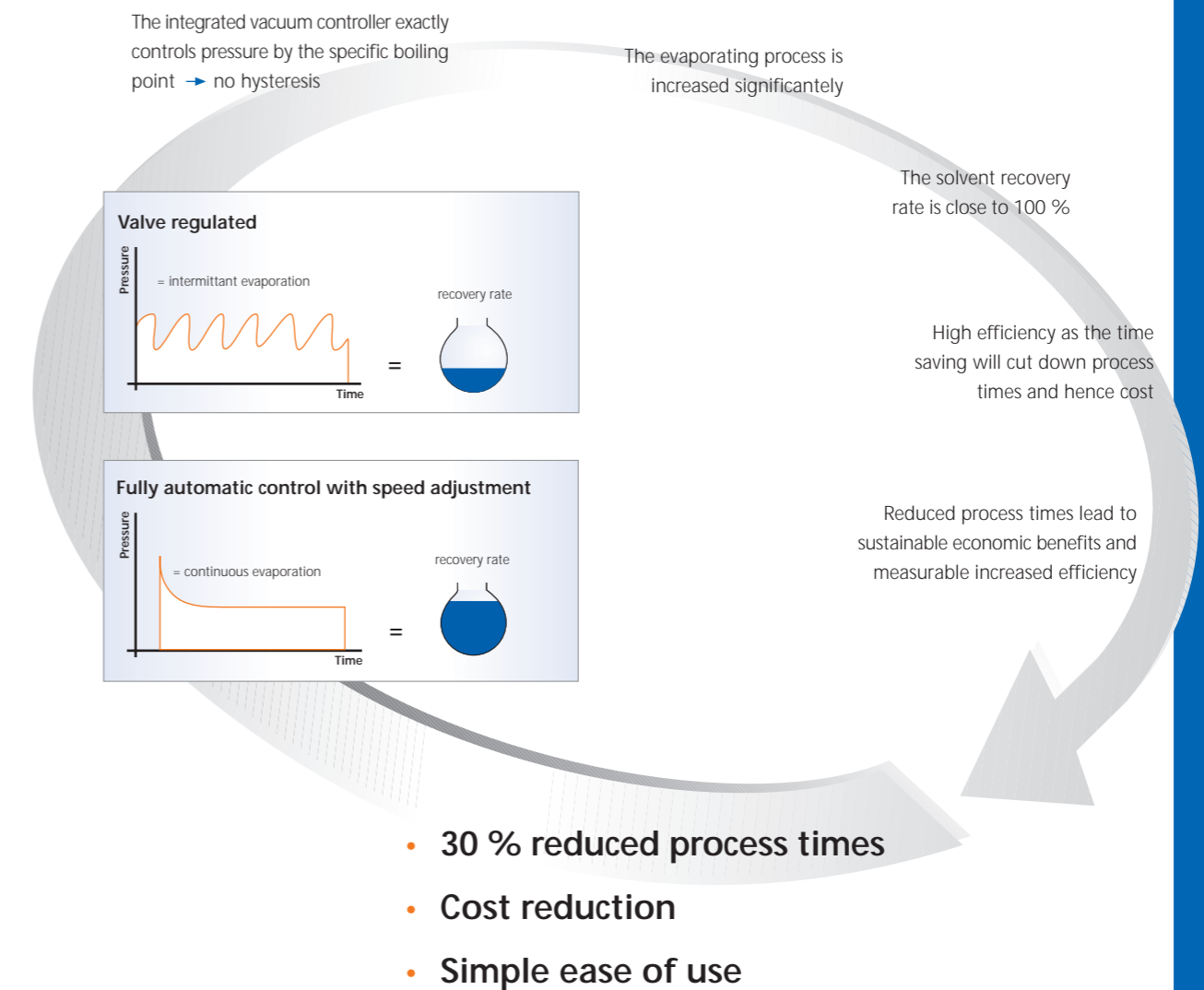

The figures prove significant time saving: When using a speed-controlled system with boil pressure follow-up in comparison with a conventional "open/close" valve control system. Used configuration: Hei-VAP Precision with program AUTO<sub>accurate</sub>

## Glassware - Hei-VAP Series

- Glassware set includes one 1000 ml evaporating flask and one 1000 ml receiving flask
- All glassware sets are also available with plastic coating (Surlyn® coated) for added safety. Except for glassware set G5 which is Halar coated
- Evaporating flasks and vapor tubes which come with a standard NS 29/32 joint size are also available with NS 24/29 ground joints (available upon request)

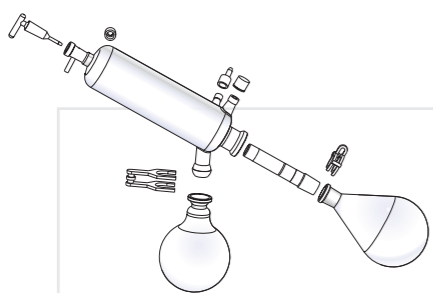

**Glassware set G1**

- Diagonal condenser for all standard distillations: the option with the **most affordable price**

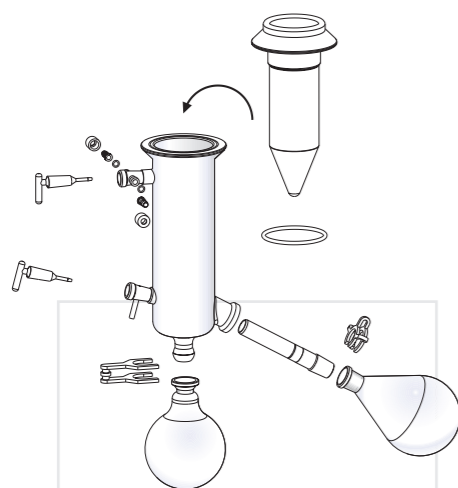

**Glassware set G5**

- **Dry Ice** Condenser for low-boiling solvents

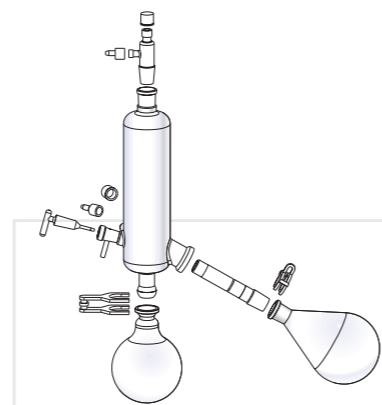

**Glassware set G3**

- Vertical condenser for all standard distillations: the option with the **smallest space requirement**

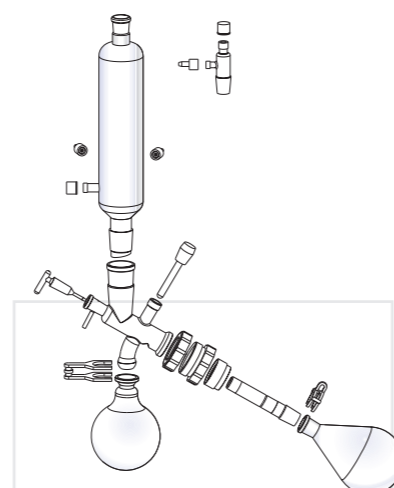

**Glassware set G6**

- Vertical condenser; centerpiece with valve **for reflux distillation**

- Also available upon request, glassware sets for Soxhlet-extraction and descending condenser system
- All glassware sets feature GL 10 thread; the inlet tube can be connected with a threaded fitting
- Glassware G3 and G6 allow for the automated distillation program AUTO<sub>accurate</sub> on Hei-VAP Precision models

## Accessories - Hei-VAP Series

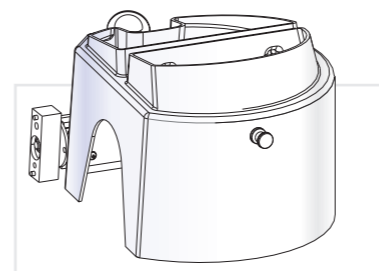

**Guard hood**

P/N 569-00010-00

Strong and super-transparent guard hood to protect you from implosions. Excellent visibility to flask. Provides easy and immediate access to flask and bath

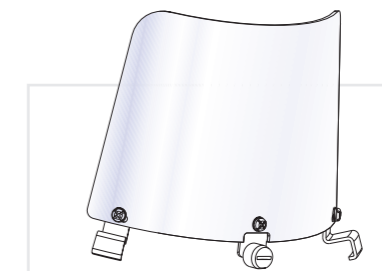

**Guard shield**

P/N 569-00020-00

Strong and super-transparent guard shield for your protection while changing flasks. Attached at the edge of the bath

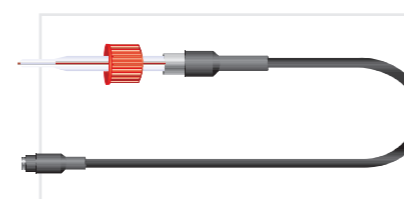

**Vapor temperature sensor**

P/N 569-00030-00

For Hei-VAP Advantage and Hei-VAP Precision models

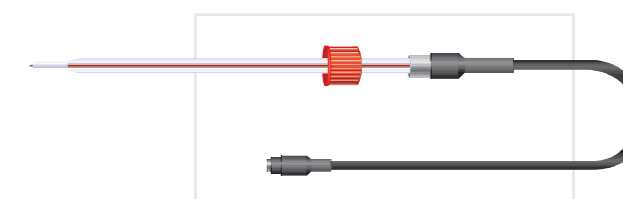

**AUTO<sub>accurate</sub>-sensor**

P/N 569-00040-00

For Hei-VAP Precision models, only in combination with glassware set G3 and G6



**Heating bath liquid (5 L)**

P/N 515-31000-00

Heating bath liquid for temperatures up to 240 °C, mixes with water



**Tube set**

P/N 591-35000-00

5 meters vacuum tubing and 6 meters water tubing



**Spare PTFE vacuum seal**

P/N 23-30-01-01-30



**Spare clamping sleeve**

P/N 23-30-01-05-31

**Spare vapor tube NS 29/32**

P/N 514-00000-01

## Accessories - Hei-VAP Series

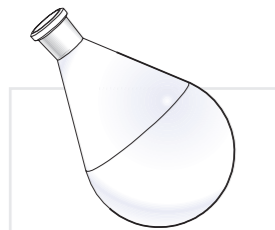

Evaporating flasks	NS 29/32	NS 24/29
Evaporating flask* 50 ml	514-70000-00	514-70000-01
Evaporating flask 100 ml	514-71000-00	514-71000-01
Evaporating flask 250 ml	514-72000-00	514-72000-01
Evaporating flask 500 ml	514-73000-00	514-73000-01
Evaporating flask 1000 ml	514-74000-00	514-74000-01
Evaporating flask 2000 ml	514-75000-00	514-75000-01
Evaporating flask 3000 ml	514-76300-00	514-76300-01

\* Evaporating flask NS 14,5 incl. adapter (NS 29 or NS 24)



Receiving flasks	Standard	Coated
Receiving flask - S 35/20 100 ml	514-81000-00	514-81000-02
Receiving flask - S 35/20 250 ml	514-82000-00	514-82000-02
Receiving flask - S 35/20 500 ml	514-83000-00	514-83000-02
Receiving flask - S 35/20 1000 ml	514-84000-00	514-84000-02
Receiving flask - S 35/20 2000 ml	514-85000-00	514-85000-02
Receiving flask - S 35/20 3000 ml	514-87000-00	514-87000-02

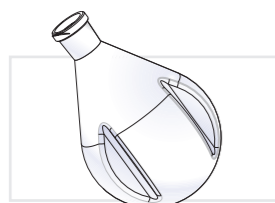

Powder flasks	NS 29/32	NS 24/29
Powder flask 500 ml	514-73200-00	514-73200-01
Powder flask 1000 ml	514-74200-00	514-74200-01
Powder flask 2000 ml	514-75300-00	514-75300-01



	NS 29/32	NS 24/29
Spider with 6 distillation sleeves NS 14.5 20 ml	15-300-005-09	15-300-005-12
Spider with 12 distillation sleeves NS 14.5 20 ml	15-300-005-10	15-300-005-13
Spider with 20 distillation sleeves NS 14.5 20 ml	15-300-005-11	15-300-005-06



	NS 29/32	NS 24/29
Spider with 5 flasks NS 24 50 ml	15-300-005-04	15-300-005-08
Spider with 5 flasks NS 24 100 ml	15-300-005-07	15-300-005-05



	NS 29/32	NS 24/29
Evaporating cylinder 500 ml	514-00070-00	514-00070-01
Evaporating cylinder 1500 ml	514-00071-00	514-00071-00



	NS 29/32	NS 24/29
Foam brake with flask clamp	514-00004-00	514-00005-00

## Vacuum accessories - Hei-VAP Series

### Vac Control Automatic

Upgrade your Hei-VAP Value/Advantage

- Control your house vacuum or any other vacuum source
- Attaches safely to evaporator
- Features 3 displays for actual vacuum, set vacuum and operating mode
- Process timer allows for unattended operations
- Reduces pressure during distillation
- Includes vacuum sensor and vent valve
- Controller finds automatically required vacuum and holds vacuum constant
- Power input: 13 W, Weight: 0.7 kg
- Dimensions: 145 x 85 x 85 (l x w x h / mm)



Vac Control Automatic  
P/N 569-00340-00

### Switchbox

Connect up to 3 rotary evaporators to one pump and control vacuum individually

- Pump switches off automatically at required vacuum
- Reduces energy consumption of pump
- Increases performance life of the pump due to a complete switch-off, if vacuum is reached
- Vacuum valve and non-return valve are required for every evaporator if you work with different pressures at the same time
- Delivery includes 3 non-return valves
- Weight: 0.6 kg
- Dimensions: 160 x 45 x 80 (l x w x h / mm)
- Designed for all Hei-VAP models with valve-regulated vacuum pumps



Switchbox  
P/N 569-00400-00

### Manual vacuum controller

For Hei-VAP Value/Advantage models

- This controller is an affordable alternative to our Vac Control Automatic, particularly for tenders or low budget projects
- Control your house vacuum or any other vacuum source
- Pressure range from 0 to 1,020 mbar
- Scaling on display in steps of 50 mbar
- Adapter for the tube with inner diameter: 8 mm
- Support rod included
- Attaches safely to evaporator
- Dimensions: 80 x 80 x 150 (l x w x h / mm)



Manual vacuum controller  
P/N 591-26000-00

### Vacuum valve

Required for Hei-VAP models with valve regulated pumps

- External attachment design for easy cleaning
- Can be combined with the Woulff Bottle to one unit

Woulff Bottle (optional)

- Additional recovery of solvent to protect vacuum valve and vacuum pump
- Direct connection to the vacuum valve
- Features connection to vacuum controller
- Volume of 250 ml



Vacuum valve  
P/N 569-00060-00

Woulff Bottle  
P/N 569-00070-00

## RPM regulated vacuum system

Designed for the Hei-VAP Precision models

RPM regulated pumps adjust their speed individually and come to a complete stop after required vacuum level is reached

### Your advantages

#### Fully automatic control with speed adjustment

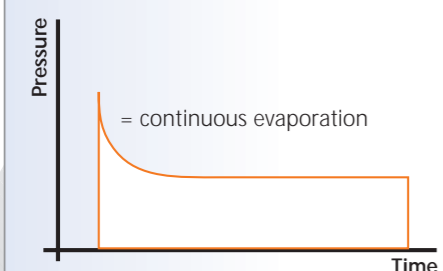

recovery rate



Speed adjustment stops completely if vacuum is reached and runs intermittently at very low speed to hold vacuum constant

Increased diaphragm performance life due to periods of non-operation

Significant noise and vibration reduction due to periods of non-operation

Low energy consumption due to intermittent operation

Most precise vacuum level at all times

Operates without vacuum valve

➔ Highest distillation rates possible while reducing process time by 30 %

➔ Stable distillation conditions accounts for solvent recovery up to 100 %

## RPM regulated vacuum pumps

### Rotavac Vario Control

Adjustable speed of the pump produces the most precise vacuum control

- Three-stage diaphragm pump is made from chemically resistant materials
- High suction capacity of 1.7 m<sup>3</sup>/h for fastest evacuation
- The Rotavac Vario Control achieves an ultimate vacuum of 2 mbar
- The Rotavac Vario Control can be combined with a condenser (P/N 591-00084-00)
- Power input: 160 W, Weight: 5.4 kg
- Dimensions: 236 x 167 x 196 (l x w x h / mm)



Rotavac Vario Control  
P/N 591-00141-00

### Rotavac Vario Tec

- Two-stage diaphragm pump is made from chemically resistant materials
- Suction capacity of 1.0 m<sup>3</sup>/h
- The Rotavac Vario Tec achieves an ultimate vacuum of 12 mbar
- The Rotavac Vario Tec can be combined with a condenser
- Power input: 160 W, Weight: 4.3 kg
- Dimensions: 236 x 156 x 196 (l x w x h / mm)



Rotavac Vario Tec  
P/N 591-00171-00  
Condenser  
P/N 591-00084-00

# Valve regulated vacuum pumps

Designed for all Hei-VAP models

## Rotavac Valve Control

- Two-stage diaphragm pump made from chemically resistant materials
- High suction capacity of 1.7 m<sup>3</sup>/h for fastest evacuation
- Suction capacity for up to 3 rotary evaporators at the same time
- The Rotavac Valve Control achieves an ultimate vacuum of 9 mbar
- The Rotavac Valve Control can be combined with a condenser
- Power input: 180 W, Weight: 10.5 kg
- Dimensions: 245 x 295 x 185 (l x w x h / mm)



Rotavac Valve Control  
P/N 591-00130-00  
Condenser  
P/N 591-00081-00

## Rotavac Valve Tec

- Two-stage diaphragm pump made from chemically resistant materials
- Suction capacity of 0.75 m<sup>3</sup>/h
- The Rotavac Valve Tec achieves an ultimate vacuum of 12 mbar
- The Rotavac Valve Tec can be combined with a condenser (P/N 591-00083-00)
- Power input: 80 W, Weight: 6 kg
- Dimensions: 315 x 145 x 169 (l x w x h / mm)



Rotavac Valve Tec  
P/N 591-00160-00

## Valve regulated vacuum pump

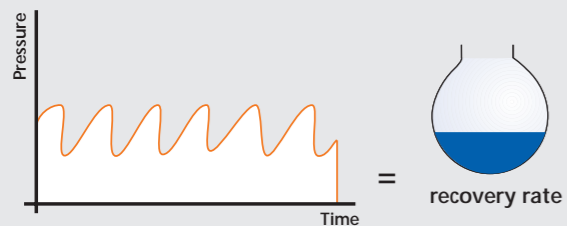

# Equipment Combinations

Hei-VAP models    Vacuum source    Vacuum control

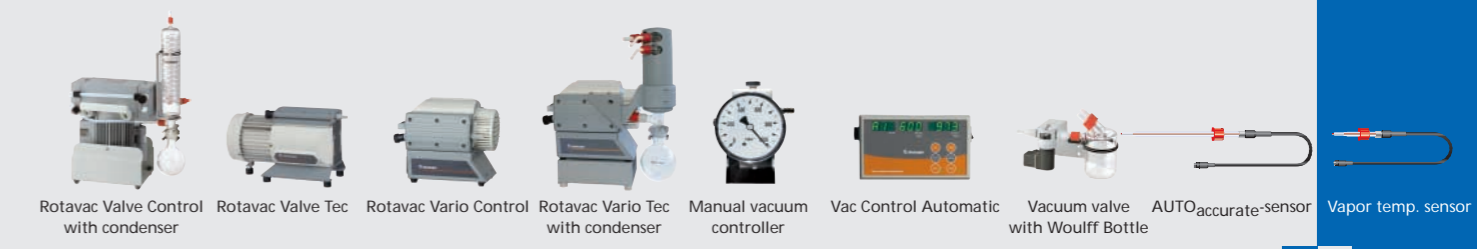
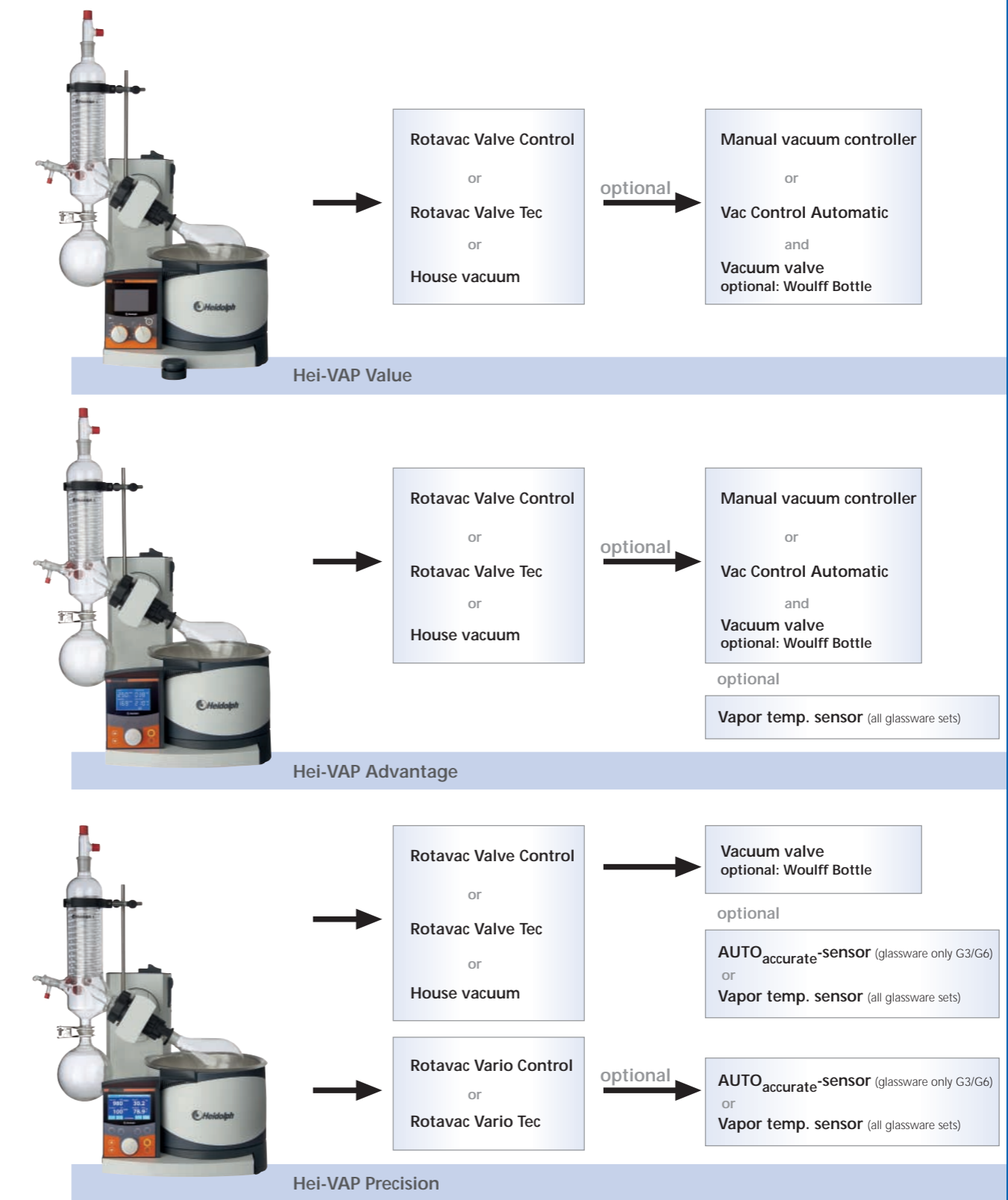

Equipment Combinations

# Chillers

## Rotacool

### High cooling capacity - minimal bench space

- The only chiller designed specifically for rotary evaporators
- Minimal bench space due to unique "L" shape design
- Long-lasting service life
- Footprint of chiller: 470 x 580 mm
- Provides space of 470 x 405 mm for evaporator
- Temperature range: -10 °C to +40 °C
- Small quantity of circulating coolant required due to innovative technology
- Precise temperature control of  $\pm 0.5$  °C
- Display for setting temperature and reading out actual temperature

Rotacool  
P/N 591-00200-00



## Rotacool Mini

### Ideal for routine applications

- Chiller for all bench top evaporators
- Small footprint of chiller: 225 x 450 mm
- Cooling temperature: 7 °C (not adjustable)
- Cooling capacity at 7 °C: 370 W
- No digital display

Rotacool Mini  
P/N 591-00210-00



## RotaChill

### The affordable model

- Temperature range: -20 °C to +100 °C
- Temperature control:  $\pm 0.2$  °C
- No digital display

RotaChill  
P/N 591-00220-00



# Summary of all Hei-VAP models

- Affordable model with hand lift for all standard applications



Hei-VAP Value with manual vacuum controller

- For your routine distillation applications and reproducible results



Hei-VAP Advantage with Rotavac Valve Control and Rotacool Mini



- For most demanding applications and the finest integrated vacuum control capabilities



Hei-VAP Precision with Rotavac Vario Control and Rotacool

	Rotacool	Rotacool Mini	RotaChill
Temperature range [°C]	-10 to +40	7 (constant)	-20 to +100
Coolant charge [L]	1.5	3.0	6.0
Cooling capacity at: +20 °C [W]	420	370	200
0 °C	350		140
-10 °C	220		100

at 20 °C ambient temperature

Heidolph offers you a complete system available from one manufacturer. All components are designed to function together perfectly – that guarantees smooth, safe and efficient operation.

This is what we mean by „Research made easy“ – to help you concentrate on research, with your findings, your company and millions of people worldwide in mind.

 Call us for a no obligation demo

# Configuration Tool

## Choose the right Hei-VAP model

Our Configuration Tool for the Hei-VAP series helps you to find the most appropriate configuration for your specific application. This tool is designed to walk you through several questions concerning vacuum source, glassware set and accessories, and upon completion, the Configuration Tool shows you which items we recommend to meet your requirements.

At [www.heidolph.com](http://www.heidolph.com) you have the possibility to use the Configuration Tool online.



Configuration Tool  
P/N 27-001-004-04

# Complete Packages at a special price

## Complete Packages BASIC

Standard equipment for your lab

### BASIC 1 T

- Hei-VAP Value with a 210 °C heating bath and hand lift incl. coated glassware set G1B, vacuum pump Rotavac Valve Tec and tube set  
P/N 560-91110-00

### BASIC 1

- Hei-VAP Value with a 210 °C heating bath and hand lift incl. coated glassware set G1B, vacuum pump Rotavac Valve Control and tube set  
P/N 560-81110-00

## Complete Packages STANDARD

For standard distillations without vacuum control

### STANDARD 3 T

- Hei-VAP Advantage with a 210 °C heating bath and hand lift incl. glassware set G1, vapor temperature sensor, vacuum pump Rotavac Valve Tec and tube set  
P/N 561-91100-00

For standard distillations with regulated vacuum control

### STANDARD 5 T

- Hei-VAP Advantage with a 210 °C heating bath and hand lift incl. coated glassware set G3B, vapor temperature sensor, vacuum pump Rotavac Valve Tec, vacuum valve, vacuum controller Vac Control Automatic and tube set  
P/N 561-41310-00

## Complete Packages STANDARD

For standard distillations without vacuum control

### STANDARD 4

- Hei-VAP Advantage with a 210 °C heating bath and hand lift incl. coated glassware set G3B, vapor temperature sensor, vacuum pump Rotavac Valve Control and tube set  
P/N 561-81310-00

For standard distillations with valve regulated vacuum control

### STANDARD 5

- Hei-VAP Advantage with a 210 °C heating bath and hand lift incl. coated glassware set G3B, vapor temperature sensor, vacuum pump Rotavac Valve Control, vacuum valve, vacuum controller Vac Control Automatic and tube set  
P/N 561-31310-00

## Complete Packages SUPERIOR

Automated distillation with Hei-VAP Precision hand lift models and valve regulated vacuum control

### SUPERIOR 1 T

- Hei-VAP Precision with a 210 °C heating bath incl. coated glassware G1B, vapor temperature sensor, vacuum valve, vacuum pump Rotavac Valve Tec with condenser and tube set  
P/N 563-61110-00

### SUPERIOR 1

- Hei-VAP Precision with a 210 °C heating bath incl. coated glassware set G3B, AUTOaccurate-sensor, vacuum valve, vacuum pump Rotavac Valve Control with condenser and tube set  
P/N 563-51310-00

## Complete Packages PREMIUM

Automated distillation with Hei-VAP Precision motor lift models and rpm-regulated vacuum control

Rotary Evaporator with **motor lift**, a 210 °C heating bath, glassware set, vacuum pump Rotavac Vario Control with condenser, AUTOaccurate-sensor and tube set

<b>PREMIUM 7</b>	Hei-VAP Precision with glassware set G3	P/N 564-71300-00
<b>PREMIUM 10</b>	Hei-VAP Precision with coated glassware set G3B	P/N 564-71310-00
<b>PREMIUM 12</b>	Hei-VAP Precision with coated glassware set G6B	P/N 564-71610-00
<b>PREMIUM 10 cool</b>	Same as PREMIUM 10, but in addition with chiller Rotacool	P/N 564-71318-00

